

**Tutorials:
Modeling**

Autodesk® 3ds Max®

2010



Autodesk®

Autodesk® 3ds® Max 2010 Software

© 2009 Autodesk, Inc. All rights reserved. Except as otherwise permitted by Autodesk, Inc., this publication, or parts thereof, may not be reproduced in any form, by any method, for any purpose.

Certain materials included in this publication are reprinted with the permission of the copyright holder.

The following are registered trademarks or trademarks of Autodesk, Inc., in the USA and other countries: 3DEC (design/logo), 3December, 3December.com, 3ds Max, ADI, Alias, Alias (swirl design/logo), AliasStudio, AliasWavefront (design/logo), ATC, AUGI, AutoCAD, AutoCAD Learning Assistance, AutoCAD LT, AutoCAD Simulator, AutoCAD SQL Extension, AutoCAD SQL Interface, Autodesk, Autodesk Envision, Autodesk Insight, Autodesk Intent, Autodesk Inventor, Autodesk Map, Autodesk MapGuide, Autodesk Streamline, AutoLISP, AutoSnap, AutoSketch, AutoTrack, Backdraft, Built with ObjectARX (logo), Burn, Buzzsaw, CAICE, Can You Imagine, Character Studio, Cinestream, Civil 3D, Cleaner, Cleaner Central, ClearScale, Colour Warper, Combustion, Communication Specification, Constructware, Content Explorer, Create>what's>Next> (design/logo), Dancing Baby (image), DesignCenter, Design Doctor, Designer's Toolkit, DesignKids, DesignProf, DesignServer, DesignStudio, DesignStudio (design/logo), Design Web Format, Discreet, DWF, DWG, DWG (logo), DWG Extreme, DWG TrueConvert, DWG TrueView, DXF, Ecotect, Exposure, Extending the Design Team, Face Robot, FBX, Filmbox, Fire, Flame, Flint, FMDesktop, Freewheel, Frost, GDX Driver, Gmax, Green Building Studio, Heads-up Design, Heidi, HumanIK, IDEA Server, i-drop, ImageModeler, iMOUT, Incinerator, Inferno, Inventor, Inventor LT, Kaydara, Kaydara (design/logo), Kynapse, Kynogon, LandXplorer, LocationLogic, Lustre, Matchmover, Maya, Mechanical Desktop, Moonbox, MotionBuilder, Movimento, Mudbox, NavisWorks, ObjectARX, ObjectDBX, Open Reality, Opticore, Opticore Opus, PolarSnap, PortfolioWall, Powered with Autodesk Technology, Productstream, ProjectPoint, ProMaterials, RasterDWG, Reactor, RealDWG, Real-time Roto, REALVIZ, Recognize, Render Queue, Retimer, Reveal, Revit, Showcase, ShowMotion, SketchBook, Smoke, Softimage, Softimage|XSI (design/logo), SteeringWheels, Stitcher, Stone, StudioTools, Topobase, Toxik, TrustedDWG, ViewCube, Visual, Visual Construction, Visual Drainage, Visual Landscape, Visual Survey, Visual Toolbox, Visual LISP, Voice Reality, Volo, Vtour, Wire, Wiretap, WiretapCentral, XSI, and XSI (design/logo).

Trademarks

The following are registered trademarks or trademarks of Autodesk Canada Co. in the USA and/or Canada and other countries: Backburner, Multi-Master Editing, River, and Sparks.

The following are registered trademarks or trademarks of Moldflow Corp. in the USA and/or other countries: Moldflow MPA, MPA (design/logo), Moldflow Plastics Advisers, MPI, MPI (design/logo), Moldflow Plastics Insight, MPX, MPX (design/logo), Moldflow Plastics Xpert.

clothfx™ is a trademark of Size8 Software, Inc. Havok.com™ is a trademark or registered trademark of Havok.com Inc. or its licensors. Intel is a registered trademark of Intel Corporation. mental ray is a registered trademark of mental images GmbH licensed for use by Autodesk, Inc. All other brand names, product names or trademarks belong to their respective holders.

Disclaimer

THIS PUBLICATION AND THE INFORMATION CONTAINED HEREIN IS MADE AVAILABLE BY AUTODESK, INC. "AS IS." AUTODESK, INC. DISCLAIMS ALL WARRANTIES, EITHER EXPRESS OR IMPLIED, INCLUDING BUT NOT LIMITED TO ANY IMPLIED WARRANTIES OF MERCHANTABILITY OR FITNESS FOR A PARTICULAR PURPOSE REGARDING THESE MATERIALS.

Modeling Tutorials

3

Modeling in 3D is similar to sculpting. Many different techniques can be used to create the objects in your scene. The techniques you learn in these tutorials can be adapted to any style of modeling you need to perform. For instance, if you're building models that will be incorporated into a game, you'll be most interested in low polygon modeling techniques. The same techniques will be equally beneficial when building highly detailed models for architectural presentations or motion pictures.

The tutorials in this section are geared for the beginning-to intermediate-level users. Each tutorial takes from 30 minutes to several hours to complete.

Beyond modeling techniques, the tutorials also expose you to the Material Editor and show you how to apply materials to objects in your scene. That familiarity will help when you dive into the [materials and mapping tutorials](#) on page 1056.

Features Covered in This Section

- Creating primitive objects
- Using a modifier to alter an object's shape.
- Creating and editing spline objects
- Converting splines into geometry using modifiers
- Setting up viewports with background images
- Editing a model at sub-object levels
- Features in Editable Poly
- Using Merge and Xrefs to bring external objects into your scene
- Using the Graphite Modeling Tools Ribbon to edit poly objects

Modeling a Chess Set

In this tutorial, you will create four pieces of a chess set—a pawn, a bishop, a rook and a knight—using various modeling tools and techniques.



In this tutorial, you will learn how to:

- Create and edit spline objects.
- Use Lathe modifier to create a 3D object.
- Use Face extrusion to create geometry.
- Use Boolean compound objects.
- Use viewport background images.
- Use the Surface modifier.

Skill level: Beginner

Time to complete: 1 hour

Modeling a Pawn

In this lesson, you will model a pawn for a set of chessmen. In a wooden chess set of standard design, pawns are turned on a lathe. You will use 3ds Max to do something similar: draw the pawn's outline, and then use a Lathe modifier to fill out its geometry. The Lathe modifier revolves the outline around a central point to create a shape, not unlike the way wood is turned on an actual lathe.



Features and techniques covered in this lesson:

- Using spline shapes to draw the outline of an object.
This lesson also briefly introduces you to spline editing.
A spline is a type of curve that is interpolated between two endpoints and two or more tangent vectors. The term dates from 1756, and derives from a thin wood or metal strip used for drafting curves in architecture and ship design.
- Editing the shape vertices and edges to better control spline drawing.
- Using the Lathe modifier to turn a 2D outline into a 3D model.

Skill Level: Beginner

Time to complete: 15 minutes

Set up the lesson:



- Start 3ds Max or, if the program is already running, choose Reset from the Application menu.
No scene file is required for this tutorial.

Set up the viewport background:

To create the profile of the pawn (and other chess pieces), you need to load a reference image into the viewport so you can trace over it.

- 1 Right-click the Front viewport to make it current.
- 2 From the Views menu, select Viewport Background. The Viewport Background dialog appears.

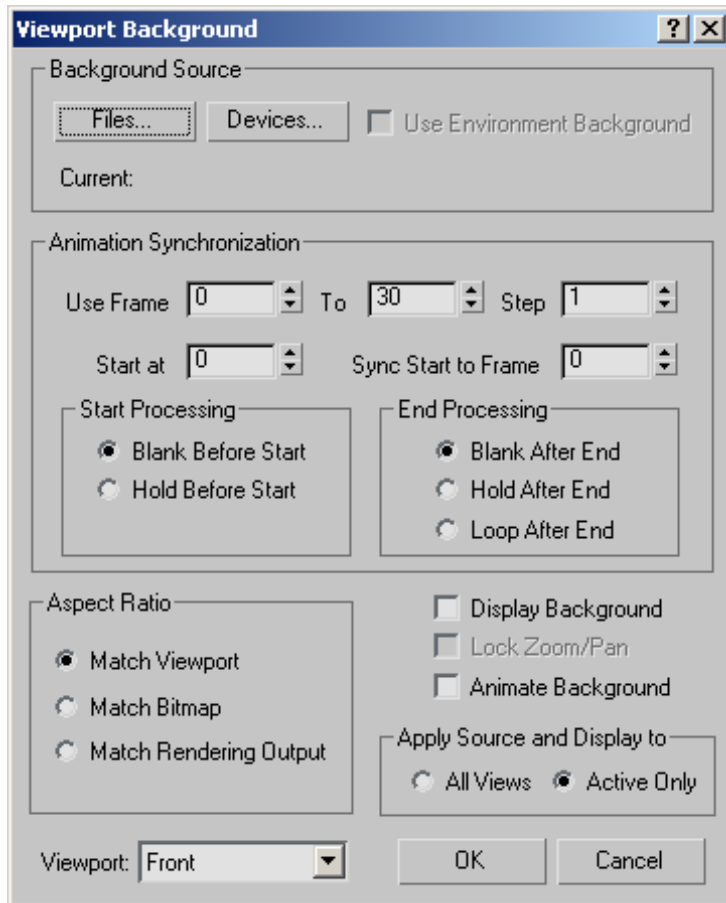

- 3 Click the Files button. navigate to the `\sceneassets\images` folder and double-click `ref-chess.jpg` to load it.
- 4 In the Aspect Ratio group, choose Match Bitmap. This ensures the image in the viewport does not get distorted.
- 5 At the right of the dialog, turn on Lock Zoom/Pan. This ensures the background image reacts to zooms and pans you may use for viewport navigation.

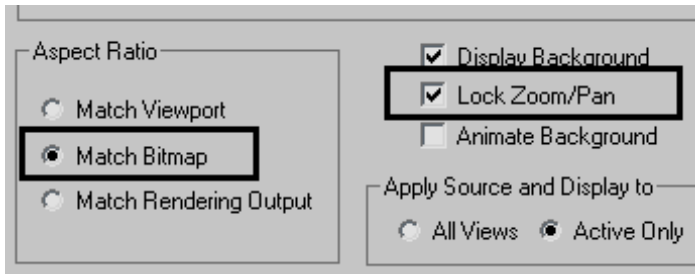

- 6 Click OK to exit the dialog. A bitmap now appears in the Front view. Press G to disable the grid, as you won't need it for this exercise.

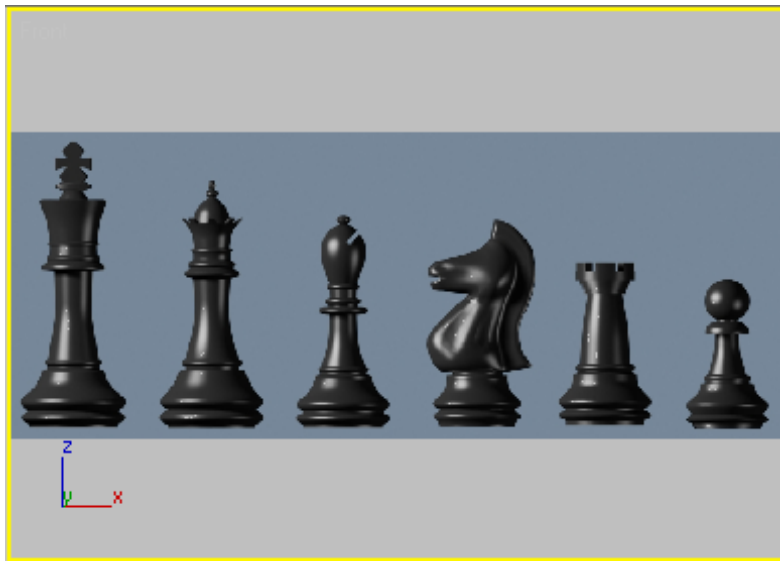

Now you are ready to begin drawing.

Start the pawn's outline:

You will draw the pawn's outline beginning with the “knob” on top.

- 1 Zoom in on the pawn reference in the Front view.

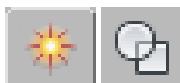

- 2 On the Create panel, click Shapes, and then click Line.

- 3 On the Creation Method rollout, set both Initial Type and Drag Type to Corner. This ensures all line segments will be linear.

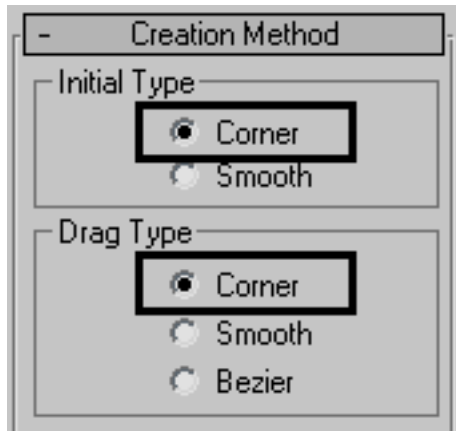

- 4 In the Front viewport, click a point near the top center. Press and hold the Shift key to constrain the line to the vertical axis and then click a second point at the base of the pawn.

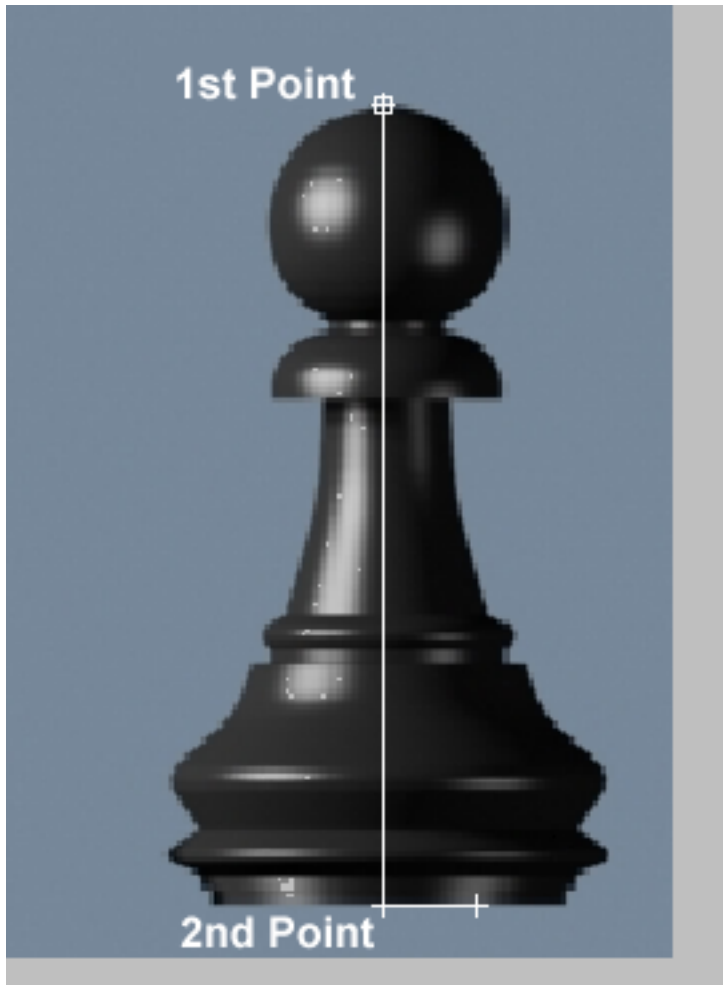

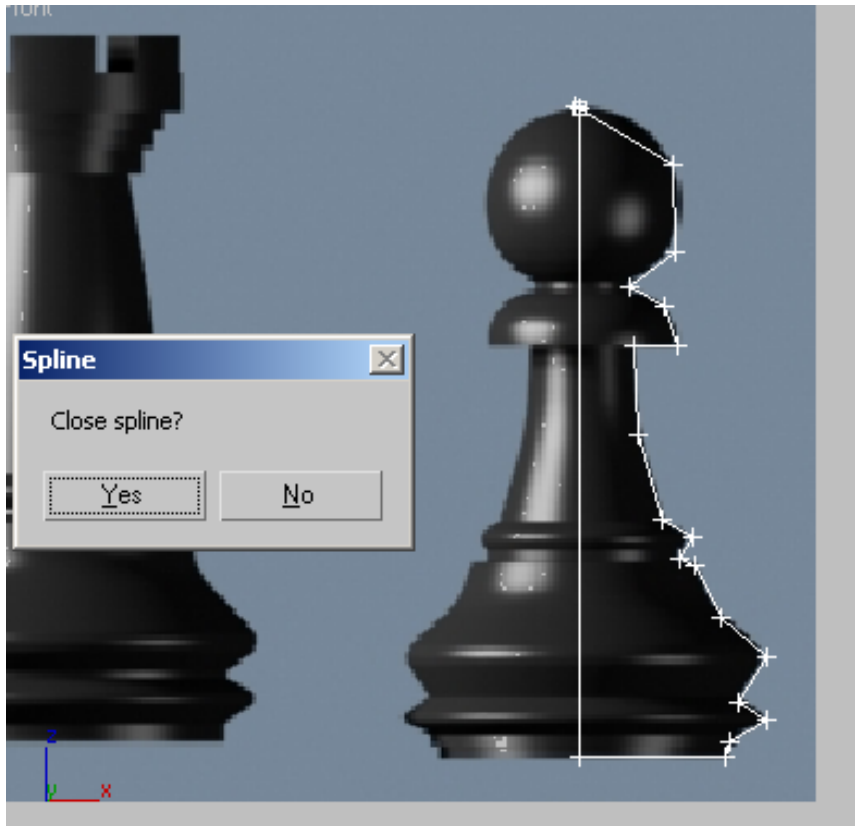

- 5 With the Shift key still pressed, click a point in the bottom-right edge of the base.
- 6 From this position, click a few points on the right contour of the reference image to create a rough profile, going up the side of the image. You do not need to be very precise at this time as you will be able to edit the profile later. To close the spline and end the command, click on the first point.



- 7 When prompted, click Yes to close the spline.

Edit the pawn's outline:

- 1  With the spline still selected, go to the Modify panel.
- 2  On the Selection rollout, click the Vertex button.
- 3 In the Front viewport, zoom in on the bottom part of the profile you created.



- 4 Use the Select And Move tool to adjust the vertices as shown in the following illustration.

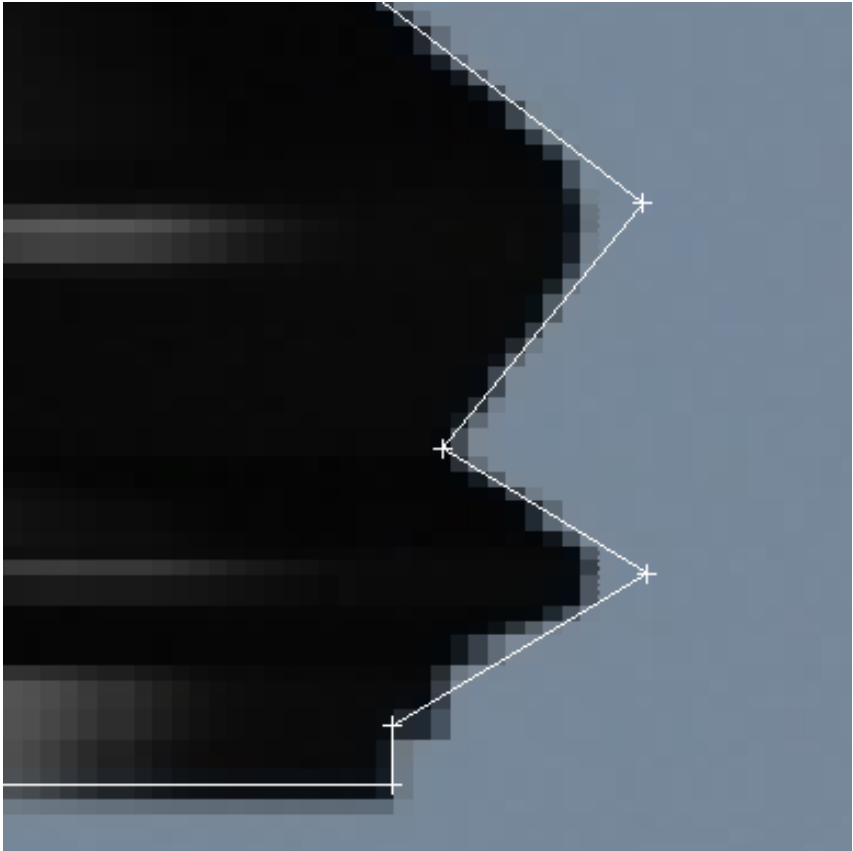

- 5 Select the two right-most vertices and in the Modify panel > Geometry rollout, activate the Fillet button.
- 6 With the Fillet command active, place the cursor on one of the selected vertices and then click and drag to round off the two corners, as shown below.



- 7 Pan up to work on the middle section of the profile.
- 8 Select the vertex above the rounded corner you just created. If necessary, move it to a better position, based on the reference image.

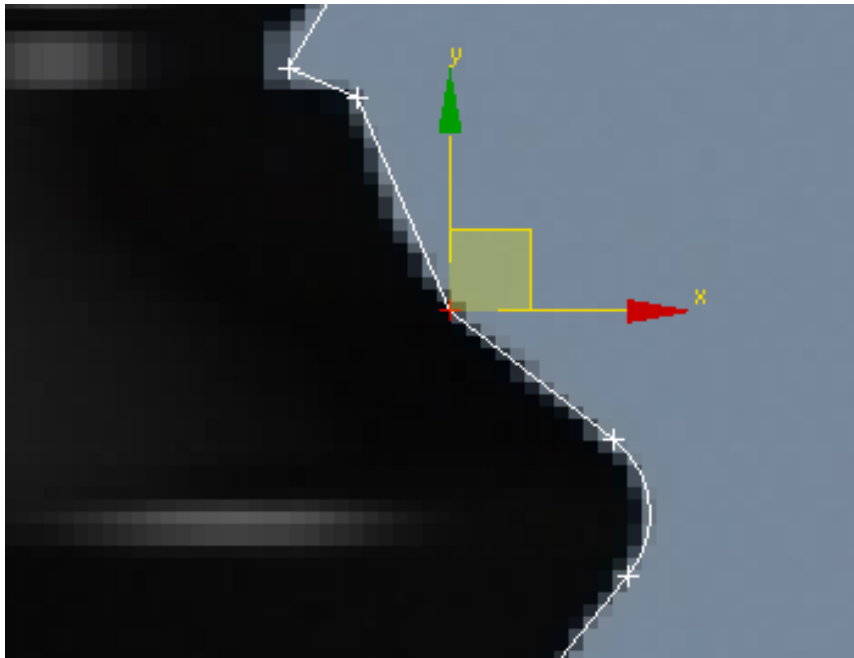

- 9 With the vertex selected, right-click in the viewport and from the quad menu that appears, choose Smooth.

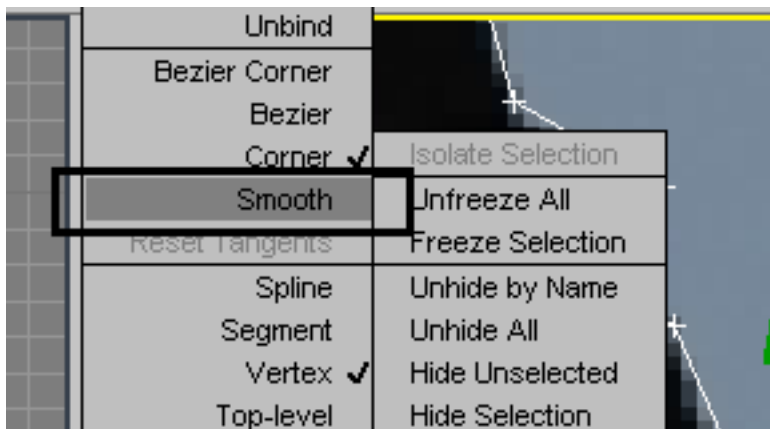

- 10 Adjust the vertex position to match the reference image.



11 Pan up to the next set of vertices.



In some situations, you might need to add a vertex.



12 On the Modify panel > Geometry rollout, choose Refine.

13 Click the line where you need to insert the vertex.

A new vertex is added to the spline.



14 Using the Move tool, adjust the position of vertices as shown in the following illustration.



- 15** Select the vertex sticking out to the right and fillet it to create a curve, as you did earlier.



- 16** Pan up the profile. Select the two vertices shown in the following illustration.

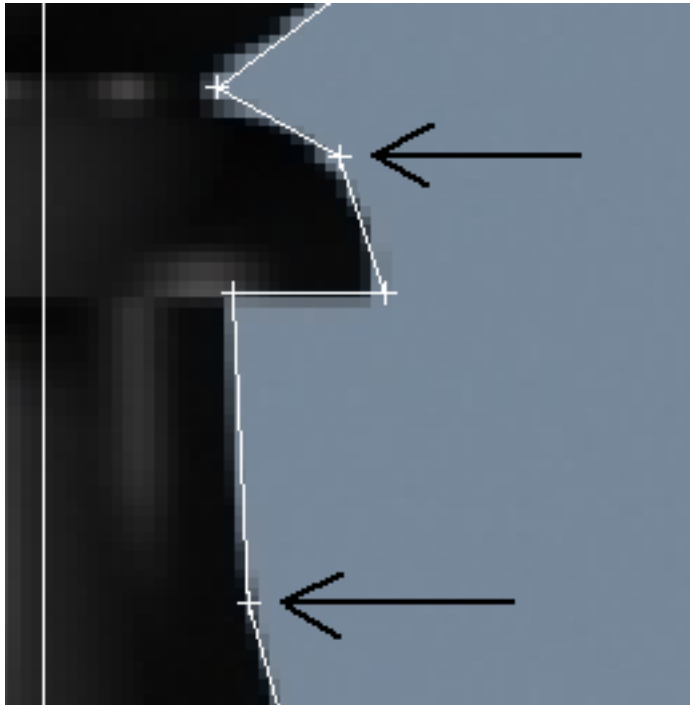

- 17 Using the quad menu, convert the two selected vertices to Smooth vertices, as you did earlier. Move them to fine-tune their positions.

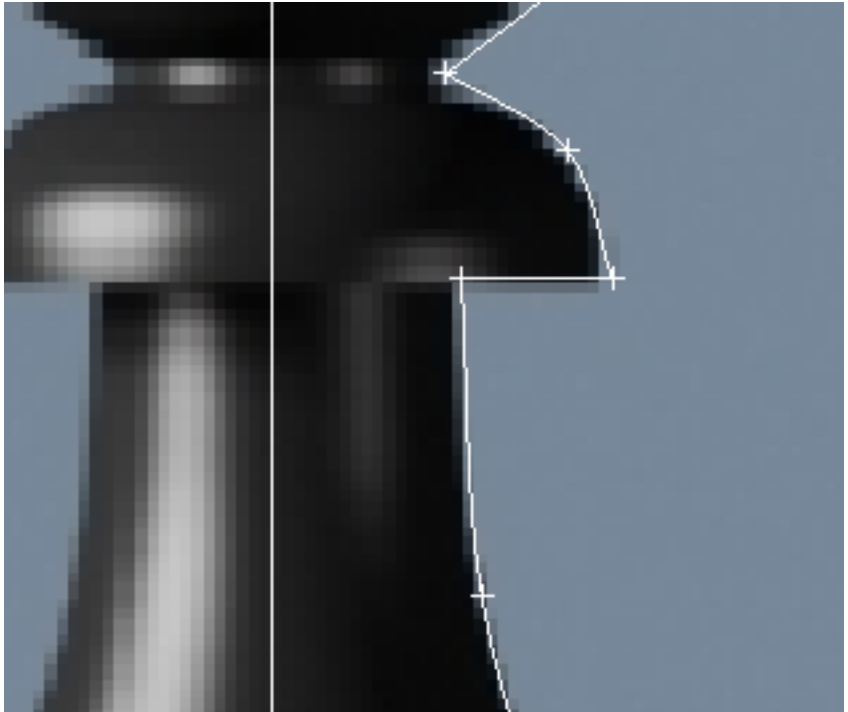

- 18** Pan up to the top part of the profile. Select the two vertices to the right of the knob and make them Smooth vertices. Again, use the Select And Move tool to fine-tune their positions.

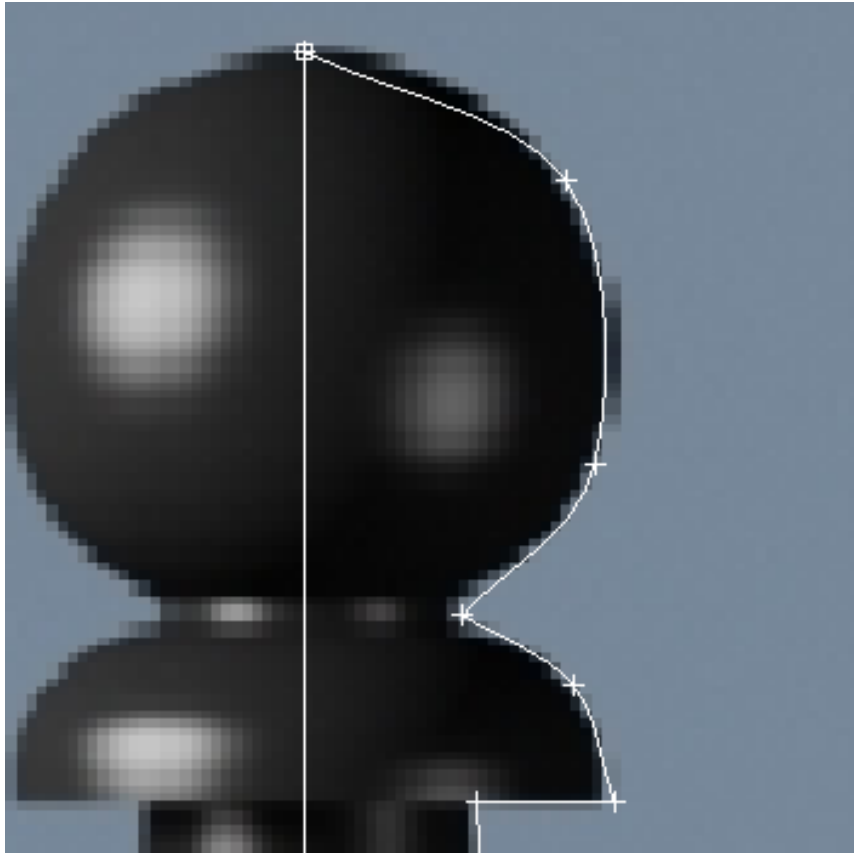

19 Zoom in to the base of the knob.

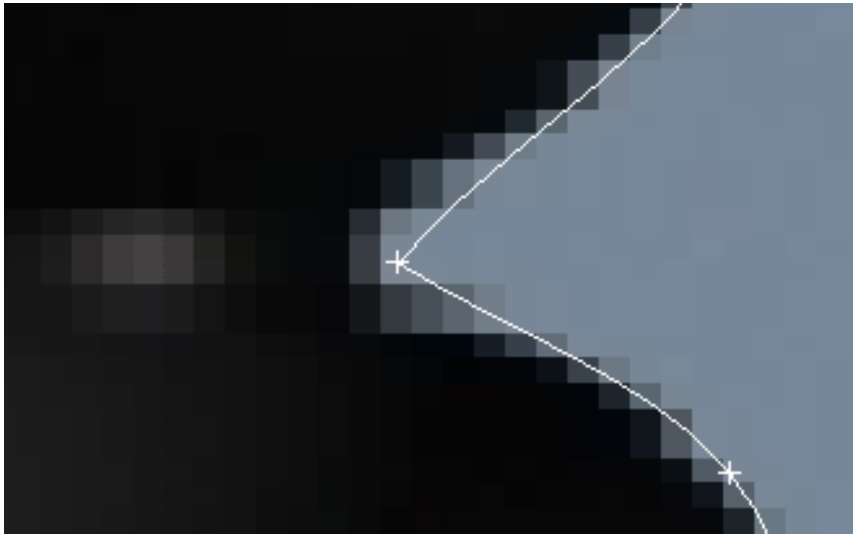

- 20 If you have only one vertex at the base of the knob, use the Refine tool as you did earlier to add another vertex.
- 21 Select both vertices and right-click to access the quad menu.
- 22 Use the quad menu to convert both vertices to Bezier Corner.

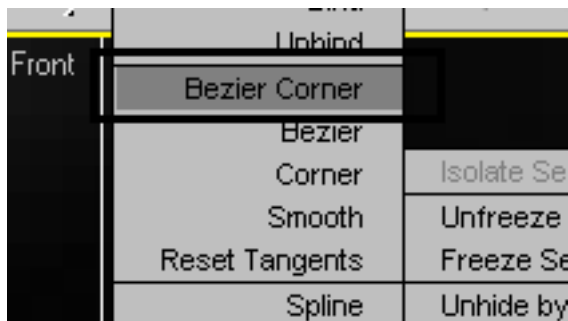

- 23 Use Select And Move to adjust the positions of the vertices and their handles to get the proper curvatures around the base of the knob.

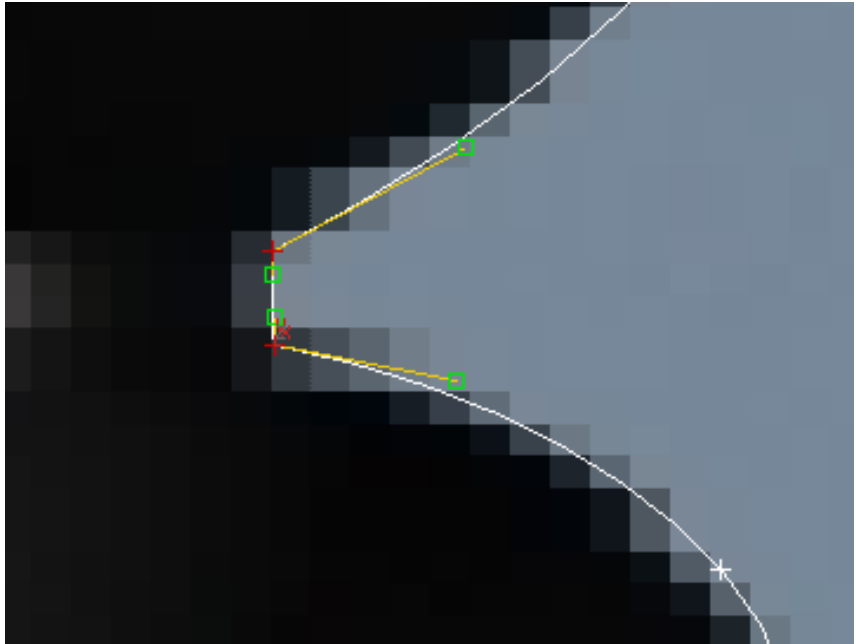

- 24 Select the first vertex you created, at the very top of the profile. Use the quad menu to convert it to Bezier Corner.
- 25 Adjust the handles to match the curvature on the reference image.

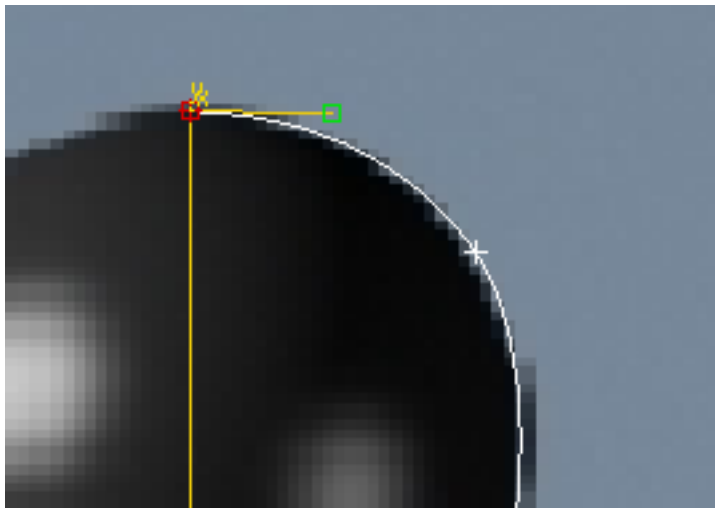

- 26 Continue refining your profile, adjusting vertex positions and types to match the reference image.



- 27 When you are done, click the vertex button in the Selection rollout of the Modify panel to exit the sub-object level.

Lathe the outline:

At this point, you can continue with the file you created in the previous steps, or you can open the file *pawn_outline_edited.max*, and continue from there. This scene is in the folder, `\scenes\modeling\intro_to-modeling\`.

- 1 Select the pawn and click Modifier List above the modifier stack display. This is a drop-down list of various modifiers.
- 2 From the list, choose Lathe.

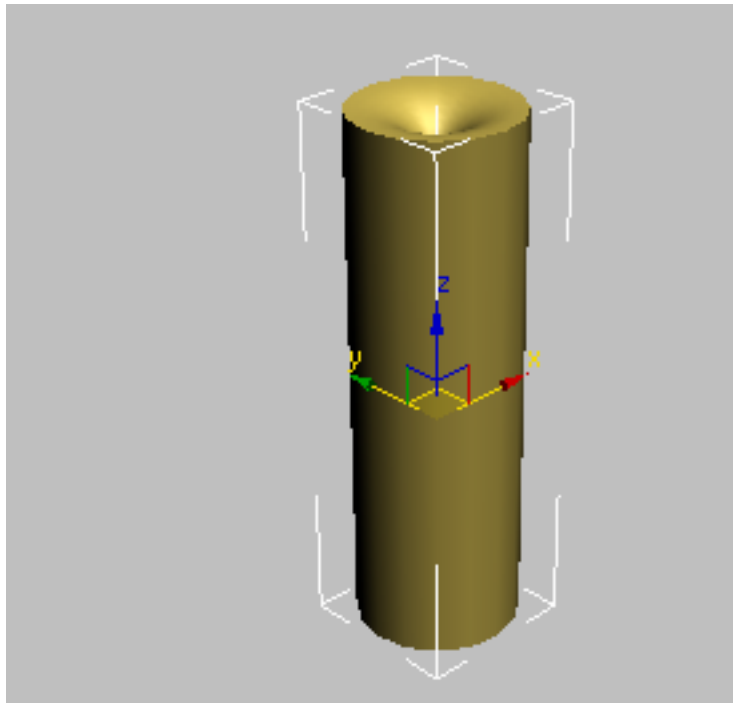

The pawn is now a 3D object.

The pawn model might not look as you expected, but that's only because the axis of revolution, by default, is based on the spline's pivot point rather than the left side of the profile. You will fix that in the next step.

- 3 On the Parameters rollout of the Lathe modifier, find the Align group and click Min.

The pawn now looks better, albeit a bit “choppy.”

- 4 On the Parameters rollout of the Lathe modifier, increase the Segments value to 32.

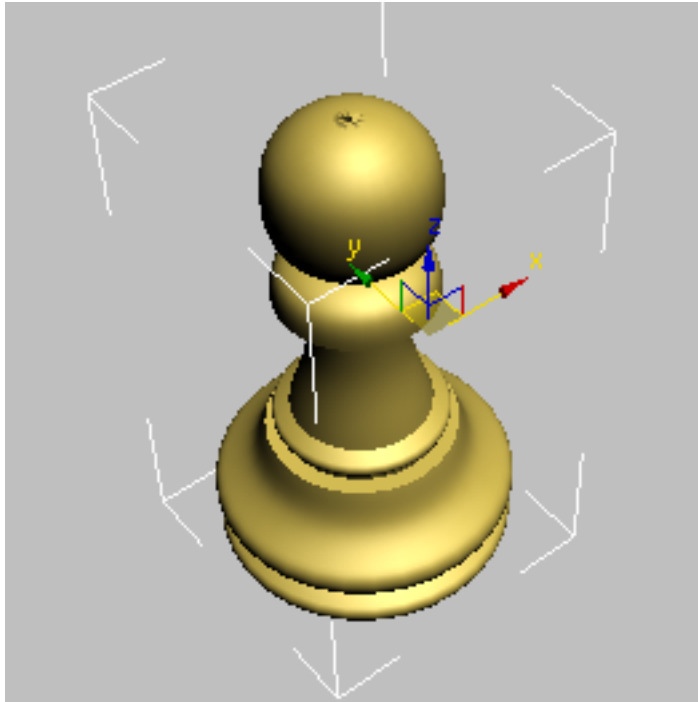

The pawn is now smoother, as you can see if you render the Perspective viewport, but the center seems a bit pinched.

- 5 On the Parameters rollout of the Lathe modifier, turn on Weld Core. This combines all the vertices at the center of the model into one.

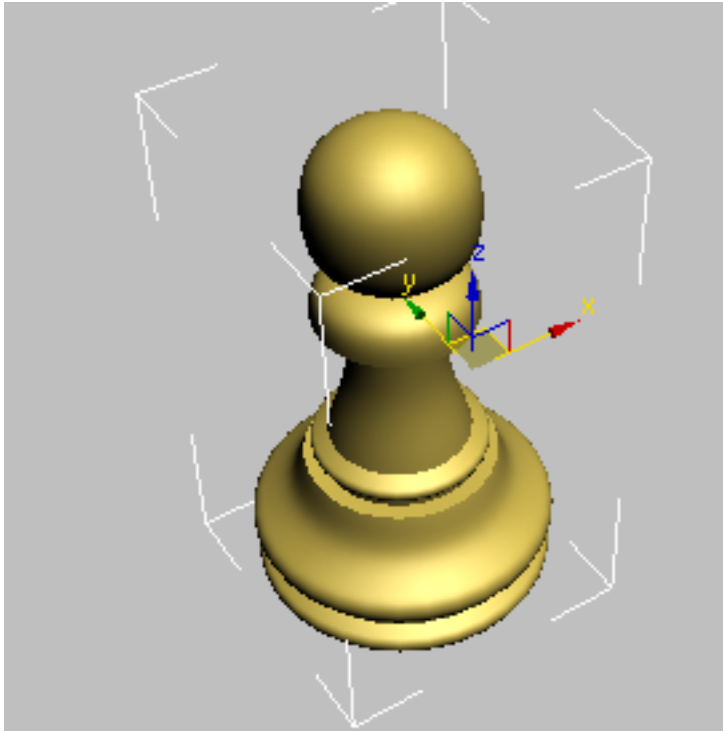

In the Introduction to Materials and Mapping tutorials, you'll provide the chess pieces with more-convincing color and texture and create a shiny, reflective, wood-grain chessboard.

Summary

In this lesson you learned spline creation and editing. You also learned to create 3D geometry using the Lathe modifier.

Modeling a Rook

In this lesson, you will model a rook for the chess set. You'll build the rook the same way as in the previous lessons, where you created a pawn and a bishop, except for the top part with the battlement. If you were making a wooden chess set, you wouldn't be able to use a lathe for this part of the piece, and so it is with the 3D model: Although the basic structure of the rook is a

lathed spline, like the pawn and the bishop, its top requires a different modeling technique.



Features and techniques covered in this lesson:

- Using face extrusion to change geometry.
- Adjusting smoothing groups for better results.

Time to complete: 15 minutes



Set up the lesson:

- 1  On the Quick Access toolbar, click the Open File button, navigate to `\scenes\modeling\intro_to_modeling` and open `rook_outline_edited.max`. This file contains the basic shape of the rook. If you prefer to build the rook from scratch, delete the profile and recreate it as you did in the previous lessons with the pawn and the bishop. Make sure, however, that you do not take into account the battlement at the top of the rook, as you will create it later using polygon extrusions.

The Front viewport should contain a reference image. If you cannot see the image, perform the following steps:

- 2 Make sure the Front viewport is active and then press **Alt+B** to open the Viewport Background dialog.
- 3 On the dialog, click the Files button.
- 4 Locate the *ref-chess.jpg* image in the `\sceneassets\images` folder and double-click it.
- 5 Click OK to exit the Viewport Background dialog.

Lathe the basic shape:

- 1  On the main toolbar, choose the Select tool. In any viewport, select the spline representing the rook's profile.
- 2  With the spline selected, go to the Modify panel. From the Modifier List, choose Lathe.
- 3 On the Parameters rollout, click the Min button in the Align group.
- 4 Set Segments to **36** and turn on Weld Core.

Prepare the top for the battlement:

- 1 With the rook still selected, make sure you are still in the Modify panel. From the Modifier List, choose Edit Poly.
- 2  On the Selection rollout, click the Polygon button.
- 3 Try selecting the top of the rook.
You can only select a fraction of the area; 1/36th of the top area, to be exact.

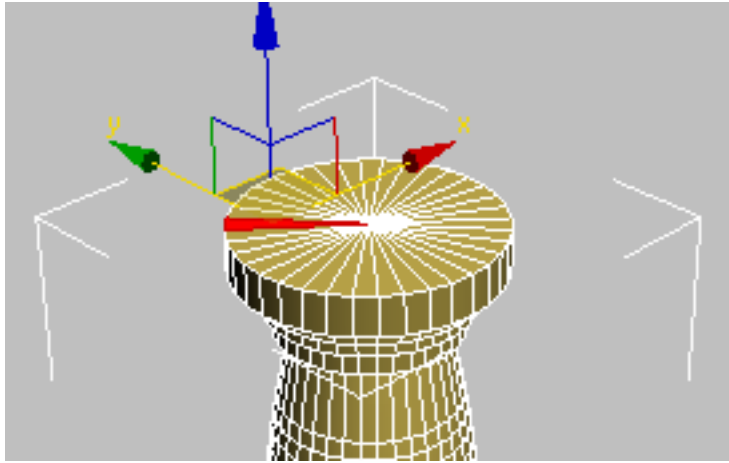

- 4 On the Selection rollout, click the Vertex button.
- 5 Select the vertex in the top-center area of the rook.

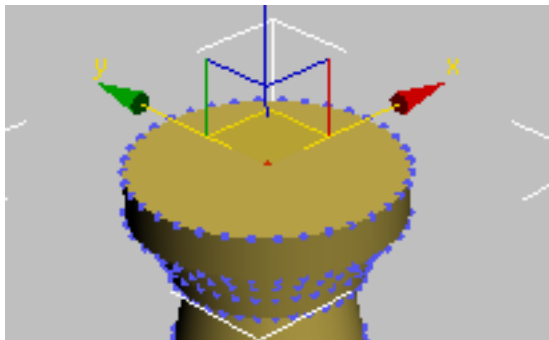

- 6 Hold the Ctrl key down and click the Polygon button again on the Selection rollout. All polygons connected to the selected vertex are automatically selected.
- 7 Press F4 to turn on Edged Faces display, if necessary. This allows you to see the shaded object and its underlying geometry.
- 8 On the Edit Polygons rollout, click the Settings button next to Inset.

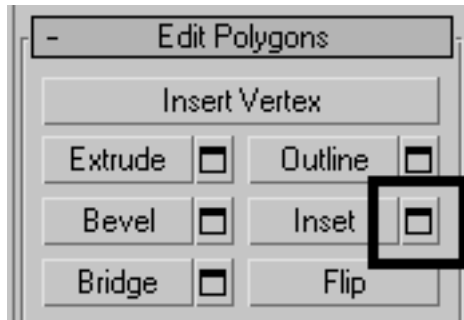

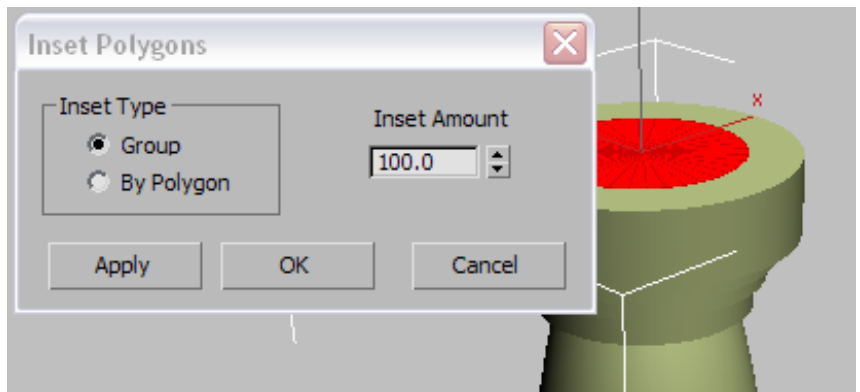

- 9 In the dialog that appears, set Inset Amount to **100.0**.



- 10 Click OK to close the dialog and save the inset.

Create the battlement:

- 1  Open the Modify panel, if necessary.
- 2  On the Selection rollout, make sure you're at the Polygon sub-object level.
- 3  Use the Select tool to select four adjacent polygons in the outer ring.

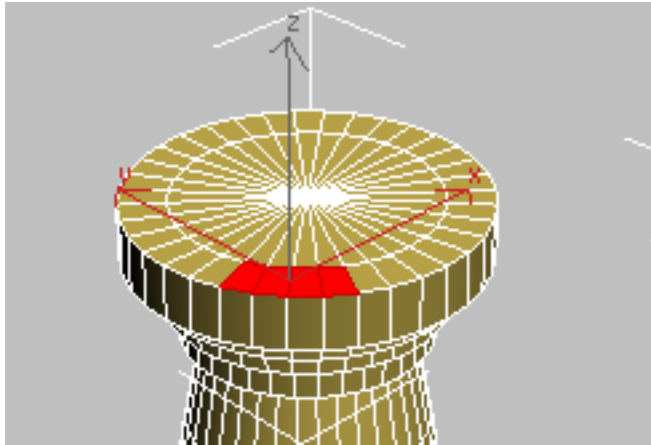

- 4 Skip the next two polys and then select the four after those. Repeat the procedure around the circumference until the selection resembles the following illustration:

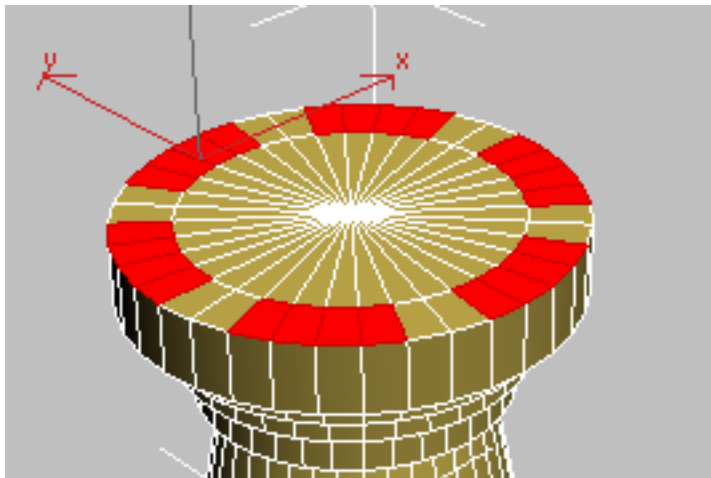

- 5 On the Edit Polygons rollout, click the Settings button next to Extrude. On the dialog that appears, set the Extrusion Height value to **40.0** to match the height of the battlement in the reference image in the Front viewport (change the value if necessary). When you are finished, click OK to save the extrusion and exit the dialog.

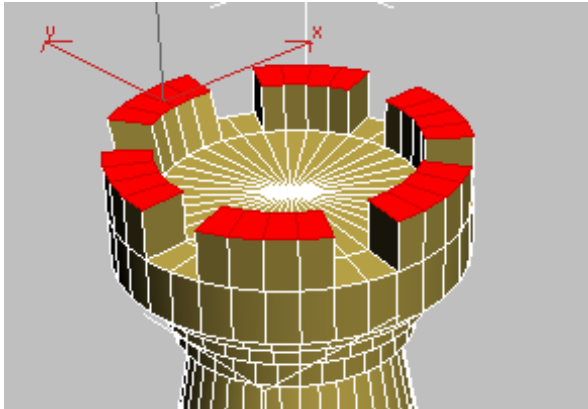

- 6 On the Selection rollout, click the Polygon button to exit this level.
- 7 Press F4 to exit Edged Faces display.
Note the faceted effect on the battlement. You will fix that in a moment.

Adjust smoothing groups:

- 1 Make sure the rook object is still selected and that you are still at the Modify panel.
- 2 From the Modifier list, choose Smooth. The entire rook now appears faceted.

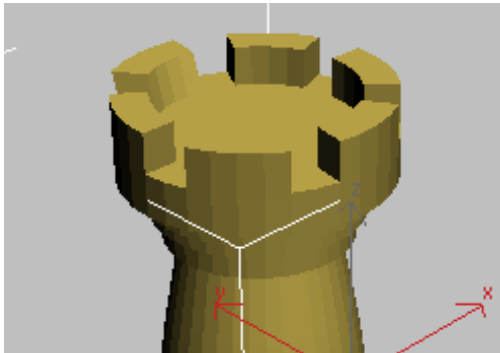

- 3 In the Parameters rollout, turn Auto Smooth on and leave Threshold at the default value of 30.0. Any two adjoining faces that meet at an angle less than that value will be made part of the same smoothing group and no edge will appear between them.

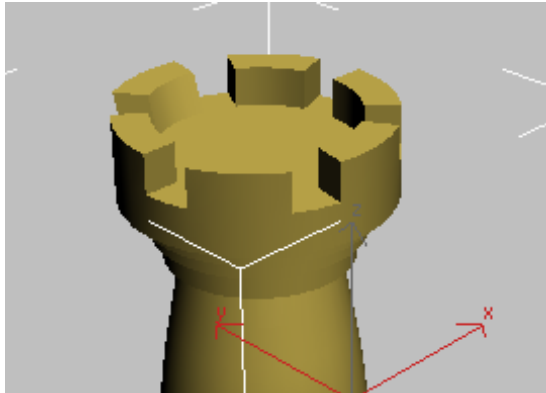

The rook appears smoother now.

Summary

In this lesson you learned to create new geometry using face extrusion. You also learned how to use smoothing groups to give your objects a smoother look.

Modeling a Bishop

In this lesson you will model a bishop for the chess set. For the most part, the bishop is modeled the same way as the pawn, based on a profile shape and a lathe modifier. The difference is the gap that shows on the bishop's head. You will use a Boolean object to achieve that result.



Features and techniques covered in this lesson:

- Using spline shapes to draw an outline of an object.
- Using the Lathe modifier to turn a 2D outline into a 3D model.
- Using Boolean to subtract geometry.

Skill Level: Beginner

Time to complete: 15 minutes

Set up the lesson:

- 1 The basic shape for the bishop is built exactly the same way as the pawn in the last lesson. Follow the procedures in the “Modeling a Pawn” exercise. Alternatively, on the Quick Access toolbar click the Open File button, navigate to the `\modeling\intro_to_modeling\bishop_outline_edited.max` file to work with a finished shape.
This file contains the profile of the bishop and a reference background image. If you cannot see the reference image, do the following steps.
- 2 Make sure the Front viewport is selected and then press Alt+B to open the Viewport Background dialog.

- 3 On the dialog, click the Files button.
- 4 Locate the *ref-chess.jpg* image in the `\sceneassets\images` folder and double-click it.
- 5 Click OK to exit the Viewport Background dialog.

Lathing the Bishop



- 1 On the main toolbar, click the Select tool. Select the spline representing the bishop's profile in any viewport.



- 2 With the Spline selected, go to the Modify panel. From the Modifier list, choose Lathe.
- 3 On the Parameters rollout, click the Min button in the Align group.
- 4 Set Segments to **32** and turn on the Weld Core option.

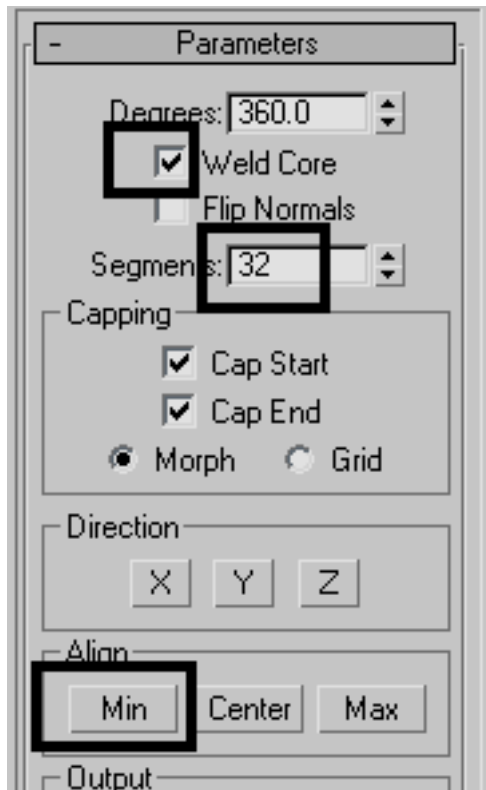



Create and position the box:

To create the gap in the bishop's head, you'll create a simple box and then subtract from the bishop model.

- 1 Zoom the Front viewport in, near the bishop's head.
- 2 From the Create menu, choose Standard Primitives > Box.
- 3 In the Front viewport, click and drag to define the base of the box. Do not worry about specific dimensions; you will change those in a moment.
- 4 Once you have defined the base, move the mouse and then click to define the height.

- 5  Go to the Modify panel and set the dimensions of the box as follows:
- Length=15.0
 - Width=2.0
 - Height=50.0

- 6  On the main toolbar, click the Select And Rotate button. Rotate the box in the Front viewport so that it is aligned with the gap on the bishop's head (in the reference image).

- 7  Use Select And Move to position the box on top of the gap.

- 8 In the Top view, move the box on the Y axis (green axis) until you can see it on both sides of the bishop.

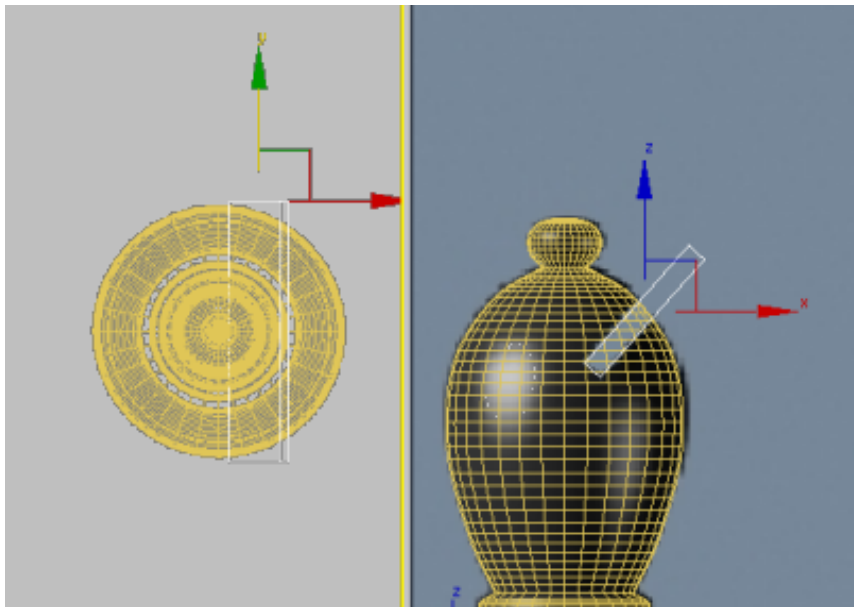

Create the slice with a Boolean operation:

- 1 Select the bishop in any viewport.
- 2 On the Create menu, choose Compound > Boolean. The bishop is now a Boolean object and the command panel automatically switches to the Create panel, showing you the parameters of the newly converted object.
- 3 On the Pick Boolean rollout, click Pick Operand B and then click the box in any viewport.

When you perform a Boolean operation, the first object selected (in this case the bishop) is recognized as Operand A and the second object selected (in this case the box) as Operand B. You can then choose the type of operation to perform, whether it's union, intersection, or subtraction, and, in the latter case, which operand to subtract from which.

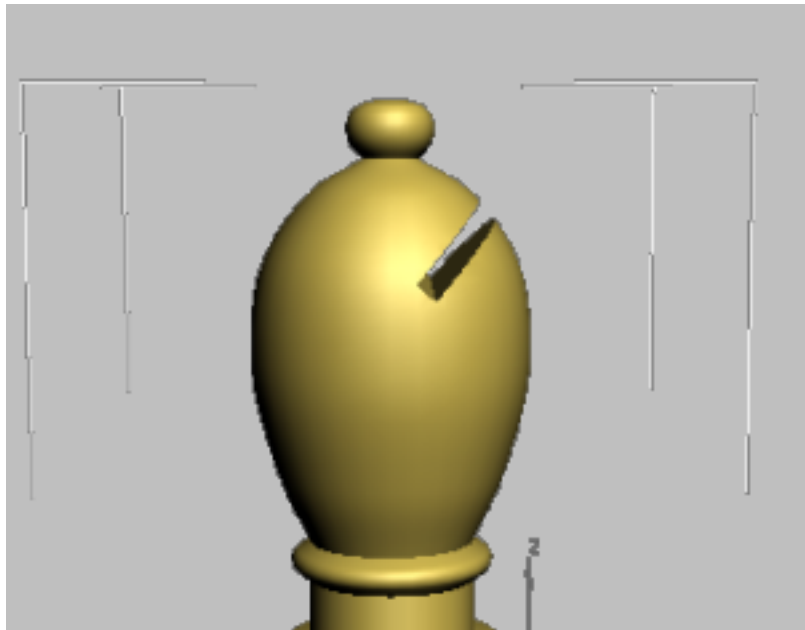

Summary

In this lesson, you learned to remove geometry by cutting a hole in an object using Boolean operations.

Modeling a Knight

In this lesson, you will create a knight for a chess set using custom splines and the Surface modifier. The Surface modifier makes a 3D surface from an arrangement of intersecting splines.



Modeling a knight presents a special set of challenges: its unique contours demand that it be sculpted carefully. The Surface modifier is ideal for this type of modeling.

Features and techniques covered in this lesson:

- Building a spline cage.
- Refining and Connecting spline vertices with new segments.
- Applying and adjusting the Surface modifier.
- Using the Symmetry modifier.
- Extruding patches using the Edit Patch modifier.

Skill Level: Intermediate



Time to complete: 1 hour

Set up the lesson:

- 1  On the Quick Access toolbar, click the Open File button, navigate to the `\modeling\intro_to_modeling` folder, and open `Knight_Start.max` .
The scene is empty except for a background picture that you will use as reference as you model the knight. If you cannot see the reference picture, follow these steps.
- 2 Make sure the Front viewport is selected and then press Alt+B.
- 3 On the dialog that appears, click the Files button.
- 4 Locate the `ref-chess.jpg` image in the `\sceneassets\images` folder and double-click it.
- 5 Click OK to exit the Viewport Background dialog.

Draw the knight outline:

- 1 Maximize the Front view by pressing Alt+W.

- 2   On the Create panel, click Shapes, and then click Line.

- 3 On the Creation panel > Creation Method rollout, set both Initial Type and Drag Type to Smooth. This will help set the base profile, given the curved nature of the chess piece.

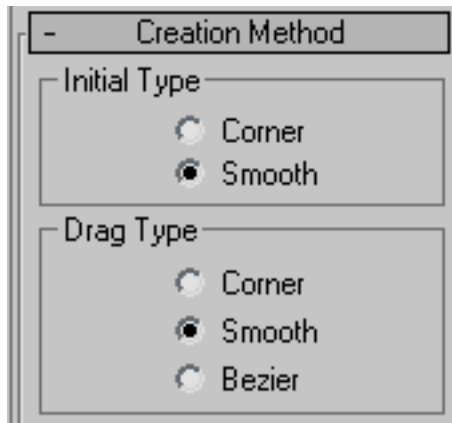

- 4 Click to create a contour for the knight. Do not take into account the horse's mane or the base for now. Keep in mind that this kind of modeling does not require a lot of detail, so try to keep the number of vertices to a minimum. You will adjust them later.

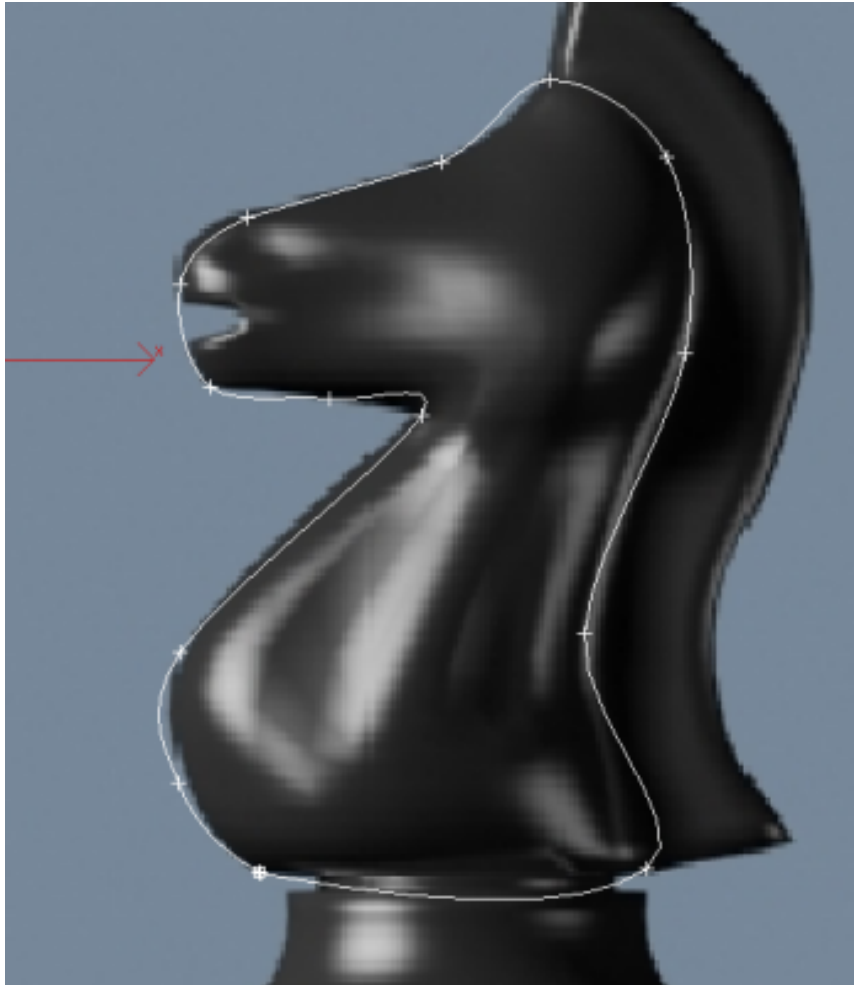

- 5 Make sure you close the spline by clicking the starting point.

- 6  Go to the Modify panel. On the Selection rollout, click Vertex.

- 7 Adjust the positions of the vertices around the shape of the knight. Select the following vertices.

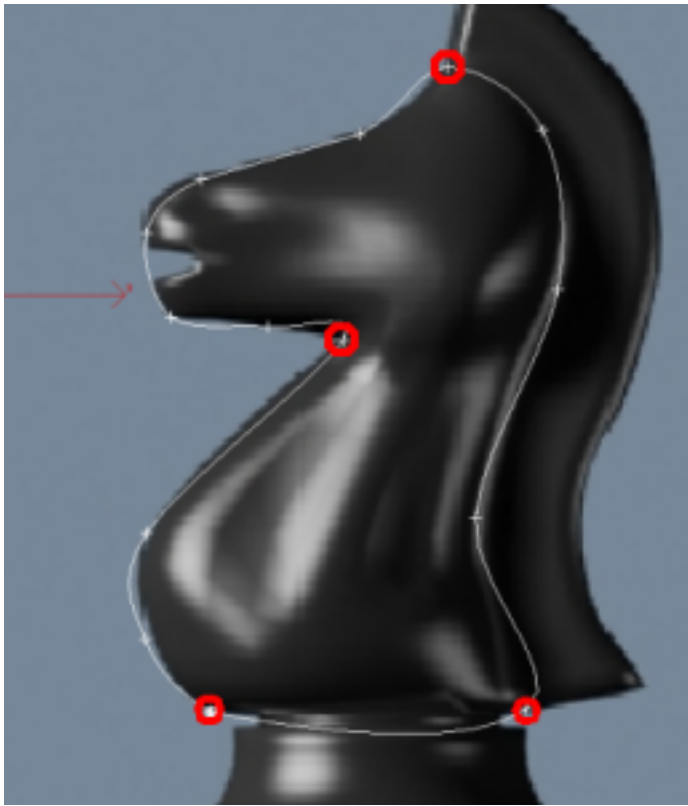

- 8 Right-click and choose Bezier Corner from the quad menu.
- 9 Use the Select And Move tool to adjust the vertex handles so that the profile fits the reference image better.

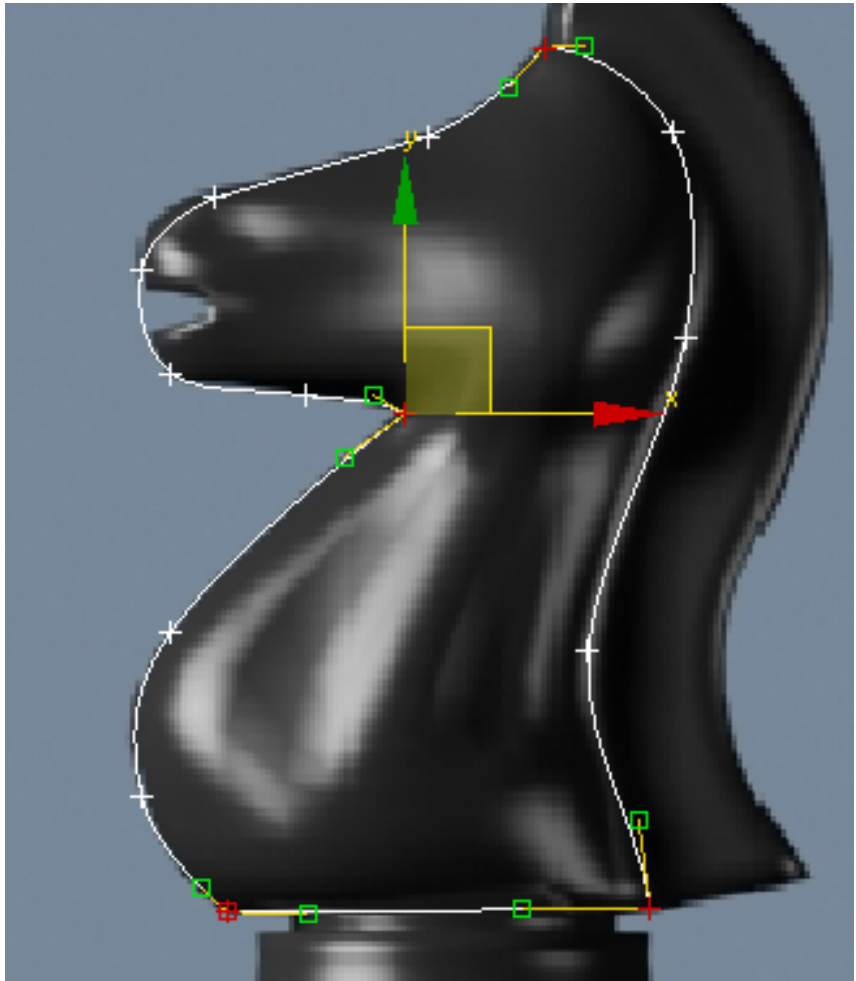

Create the inner spline cage:



- 1 You will start adding detail where the head intersects the neck. On the Modify panel > Geometry rollout, turn on Connect and then click Refine.

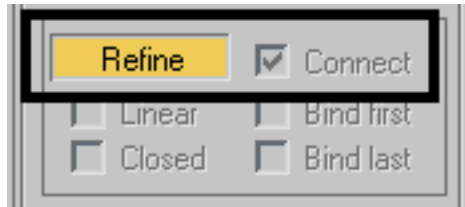

NOTE Refine adds vertices to a spline. If the Connect option is on, all inserted vertices will be connected by segments in the order they were created.

- 2 Click the Bezier Corner vertex at the intersection of the head and the front of the neck.

A dialog opens:

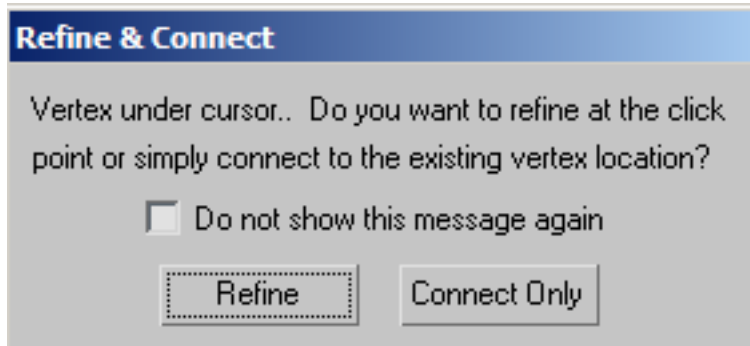

This dialog points out that there is already a vertex where you clicked. You still have the option to refine the spline, adding yet another vertex very close to the existing one, or you can simply use the existing vertex and connect it to others you will be inserting. Typically, use the Connect Only method when this warning appears.

- 3 Click Connect Only.

NOTE The warning dialog can be distracting, and some users prefer to turn on "Do not show this message again" before they close it. On the other hand, if the dialog does *not* appear, you might forget which behavior is in effect while you use Refine and click near an existing vertex. We leave this choice up to you.

- 4 Click a point to the right at the back of the neck.

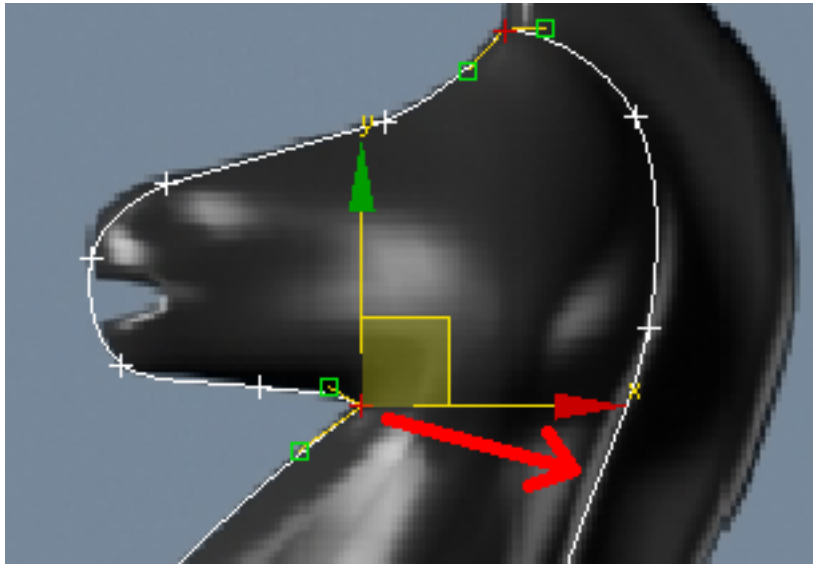

- 5 Right-click to finish the command. You now have an additional segment going from the front to the back of the neck.

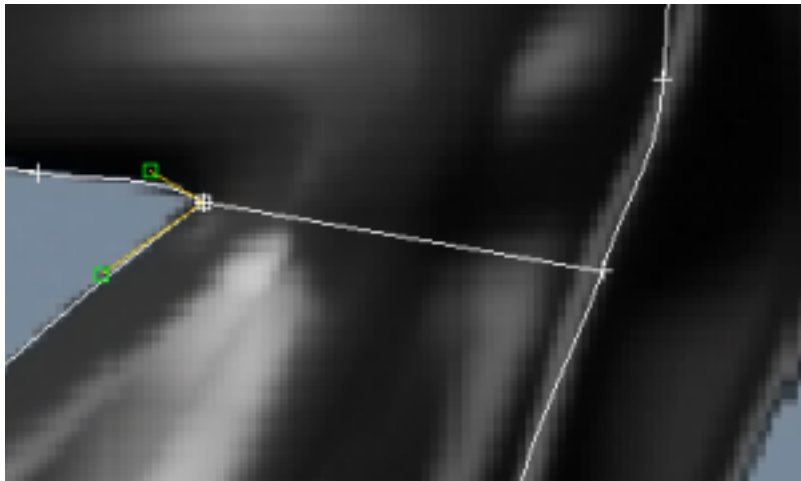

- 6 Add two more “levels” to the neck as shown in the illustration below.

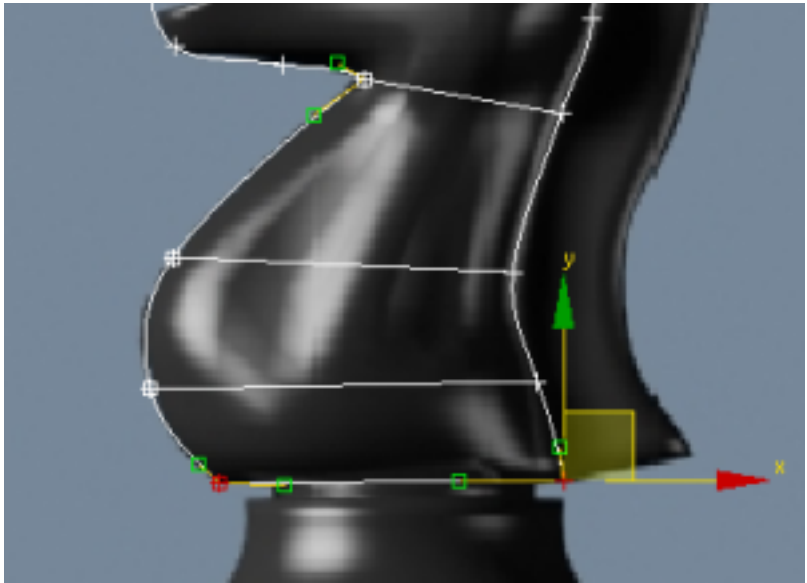

- 7 Use Refine/Connect to add a vertical line of detail going from the neck to the head.

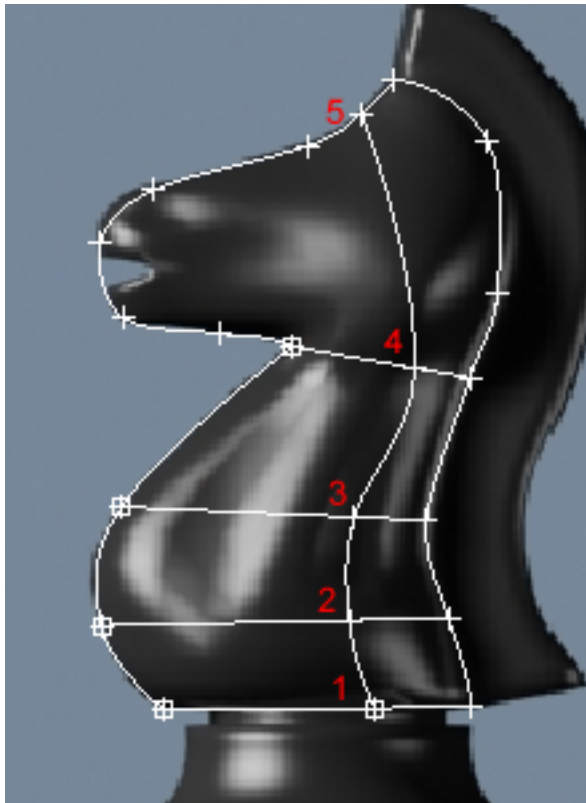

- 8 Continue adding detail until the spline cage looks similar to the following illustration.

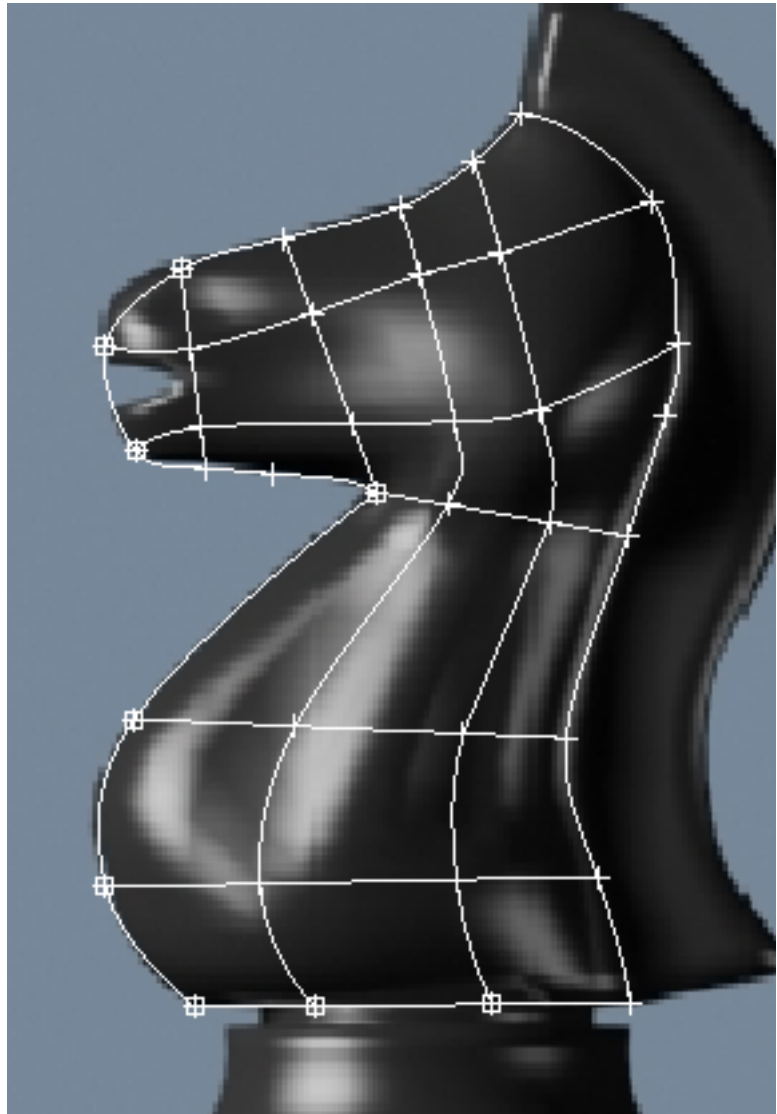

Delete unwanted vertices:

The next step is to ensure that there are no loose vertices on the spline cage. In this method of modeling, it is essential that the spline cage is made of three- or four-sided areas only.

- 1 Make sure the spline is still selected and that you are still at the Vertex sub-object level.
- 2 Look for any loose vertices and select them.
- 3 Press Delete to remove the unwanted vertices. Make sure that a quad area has no more than four vertices, where segments intersect.

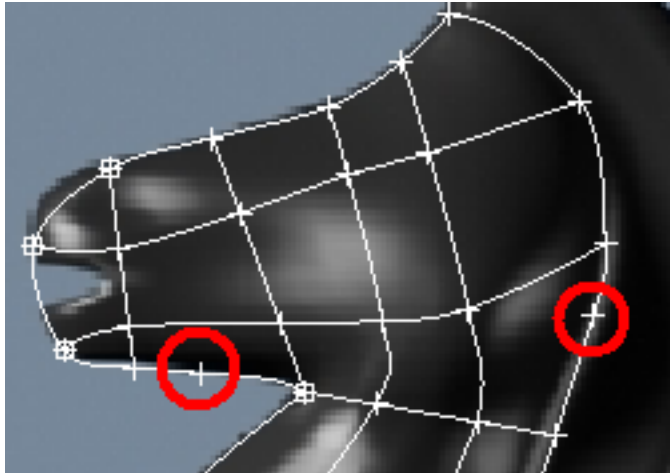

Fine-tune the spline cage:

The next step is to adjust the spline cage to get a nice flow of segments. When you refined the spline cage, you introduced a number of intersecting segments and subsequently a number of intersecting vertices. It is very important that these vertices which share the same position in space be moved together.

- 1 Make sure the spline is still selected and that you are still at the Vertex sub-object level.
- 2 In the Selection rollout, turn on Area Selection and leave the value at 0.1. This ensures that when you select a vertex by clicking it, all vertices that are within the distance specified in the threshold value get selected as well.

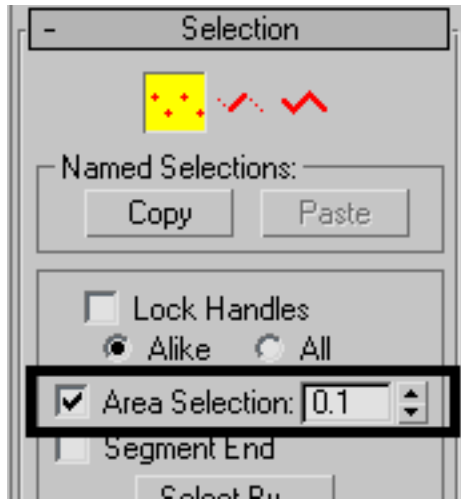

- 3 Use the Select And Move tool to relocate vertices to get a nice flow of segments in the spline cage.

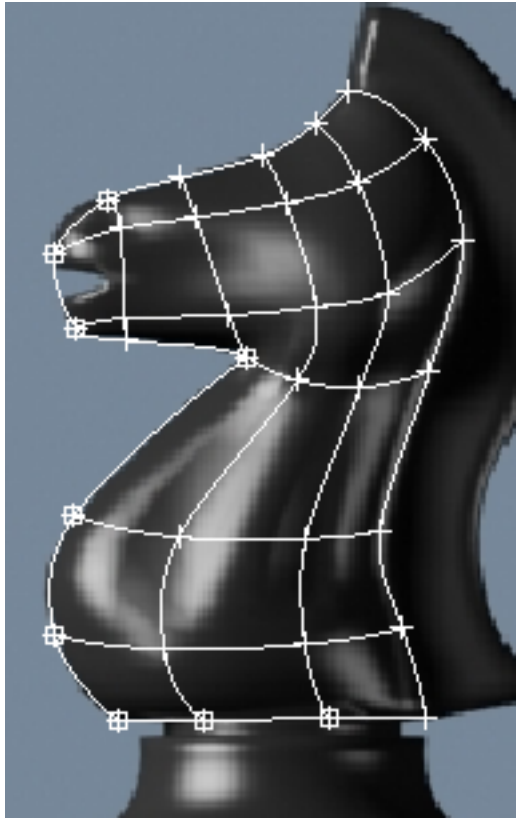

Give the spline cage volume:

So far, you've built everything in the Front viewport. The collection of segments lies therefore in the same plane. In this step, you will adjust the spline cage so that it starts shaping into a 3D volume.

- 1 If the Front viewport is still maximized, press Alt+W to return to the four-way viewport layout.
- 2  Click Zoom Extents All to see the spline cage in all four viewports.
- 3 Using the Select tool and the Ctrl key, select all the internal vertices plus the two center ones on the bottom segment.

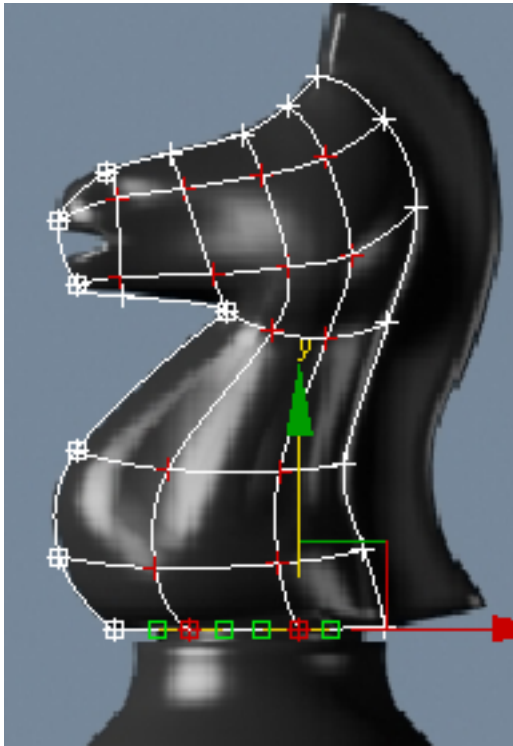

- 4 In the Top viewport, move the selected vertices down on the Y axis (green axis).

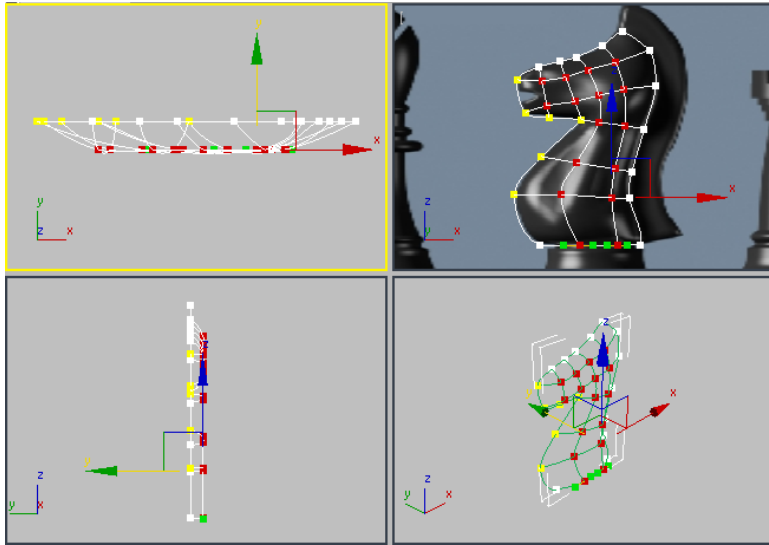

- 5 Keep adjusting the position of these inner vertices to give the volume a more interesting shape (narrower snout, thicker bottom neck, and so on). Feel free to experiment but *do not move* the other vertices around the perimeter; you need them to be in their original position later, when you mirror the object.

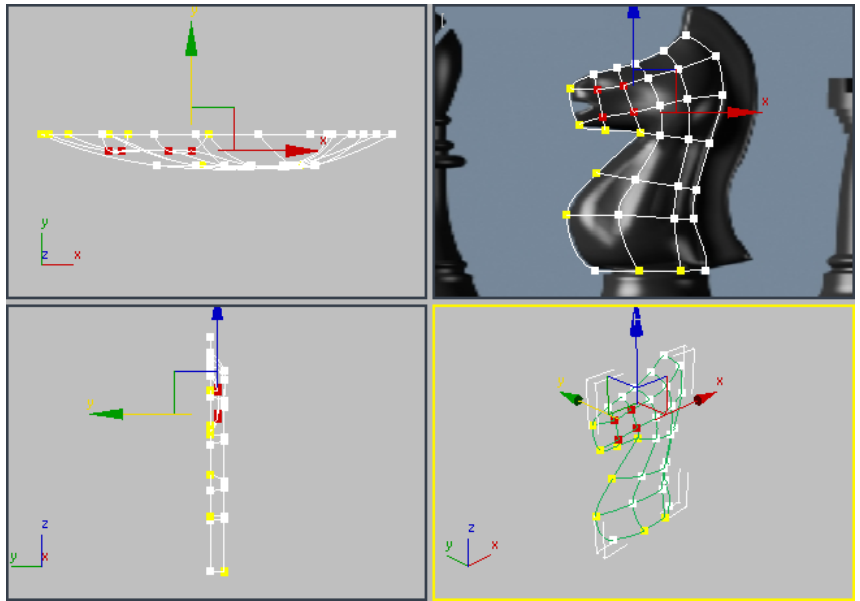

Adjust the tangents on the perimeter:

- 1 Select all the vertices that run along the back of the neck, except for the top one.



- 2 Right-click the viewport and convert the selected vertices to Bezier Corner.
- 3 Move the angled tangents so they are in a more vertical position. This will give the segments a stronger angle of attack as they meet the mirror line.

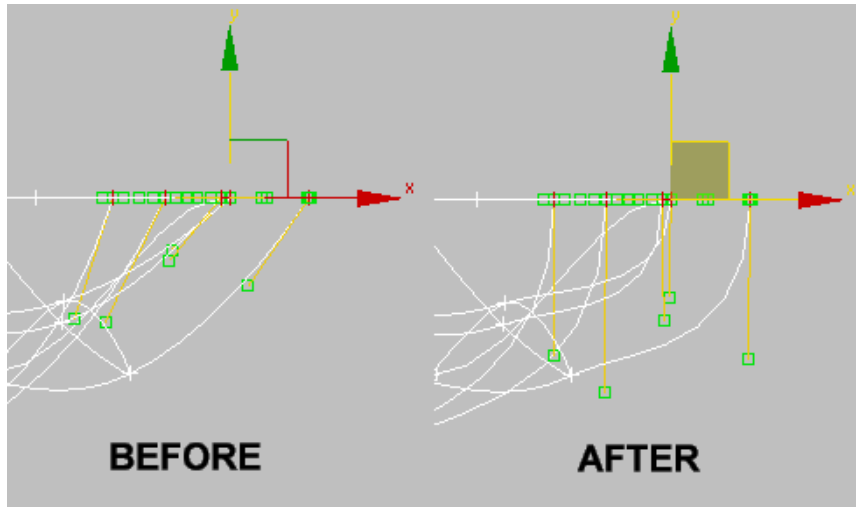

TIP If you try to move the tangents and find the direction locked in one axis or another, press F8 to constrain motion to the XY plane.

- 4 Repeat this procedure on the two vertices near the mouth, and those running up the front of the neck.

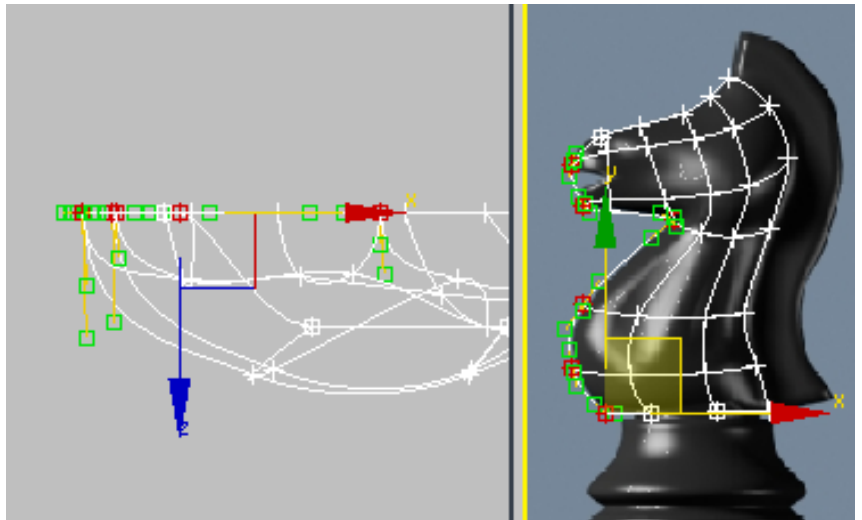

- 5 Repeat the procedure on the vertices running along the top of the head, but then use the Front viewport to make the tangents horizontal.

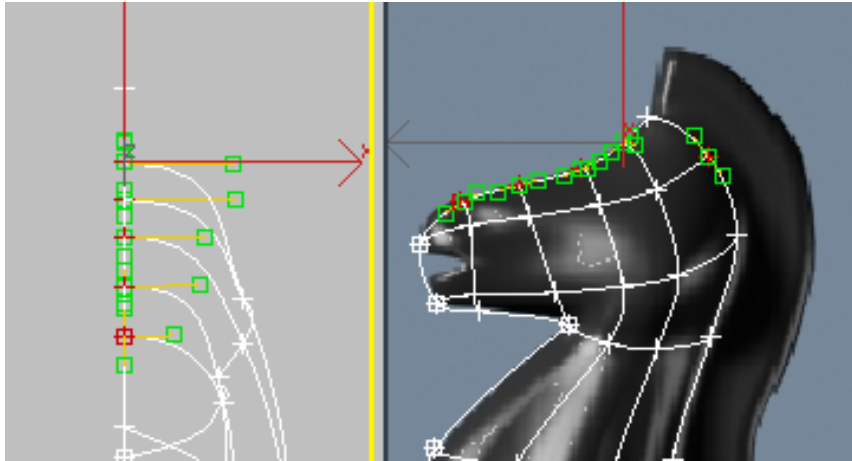

Test the Surface Modifier

You will eventually mirror this spline arrangement to make the other side of the knight, but before doing so, you need to check the current setup to see if the Surface modifier works on it.

The Surface modifier places a 3D surface over each set of three- and four-sided polygons formed by the splines.

The polygons must be completely closed in order for the Surface modifier to make the 3D surface. By trying out the Surface modifier now, you can correct any “holes” in the surface before you mirror the splines.

- 1 With *Line01* selected, exit the Vertex sub-object level.
- 2 From the Modifier List, choose Surface from the Object-Space Modifiers section. Depending on how you built your spline cage, the appearance of the knight in the Perspective viewport might look solid or hollow.

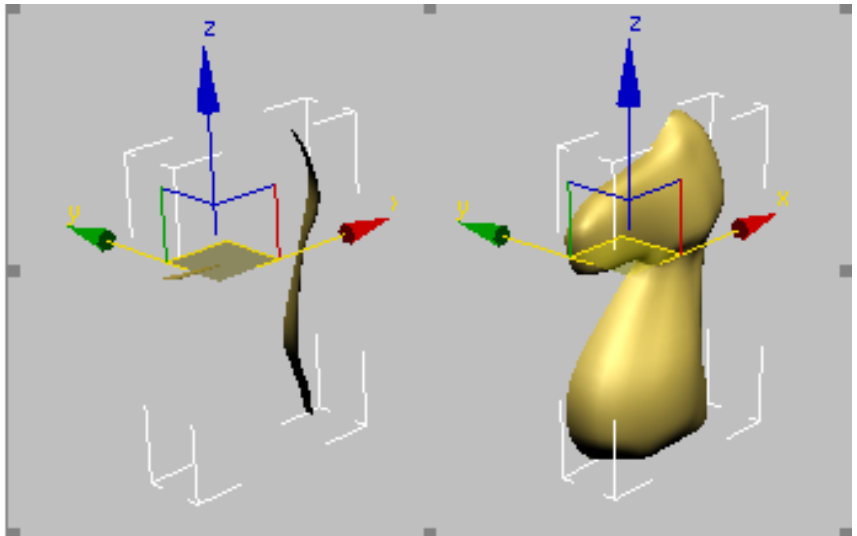

- 3 In the Parameters rollout, try turning the Flip Normals option on or off until the knight appears as shown on the right side of the illustration above.
- 4 Expand the Line entry in the modifier stack and then click Vertex. Turn on Show End Result so you can work on the spline cage and see the effect of the Surface modifier simultaneously.

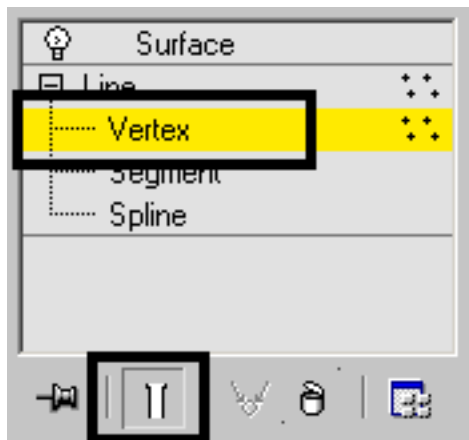

- 5 In the Front viewport, select the vertex on the neck where you see a dip in the muscle tones. Right-click and convert that vertex to Bezier Corner.

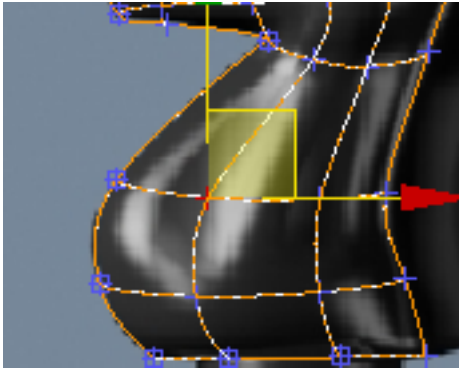

- 6 In the Top viewport, adjust the handles into a sharp inverted V. This will help simulate the muscle tones on the neck. Keep an eye on the Perspective viewport for reference.

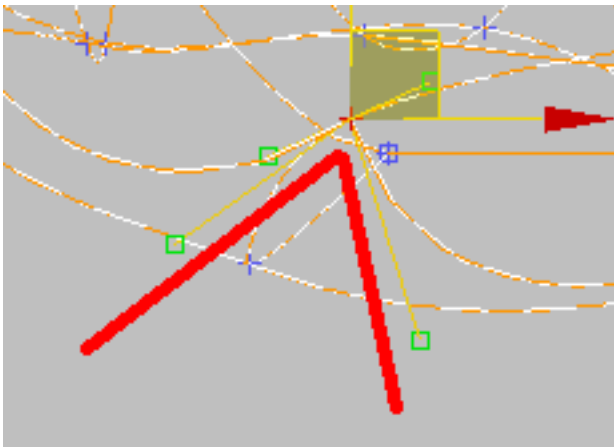

- 7 Experiment with this vertex and others to mold a better-looking neck. You can use this technique on other parts like the snout or the head as well.

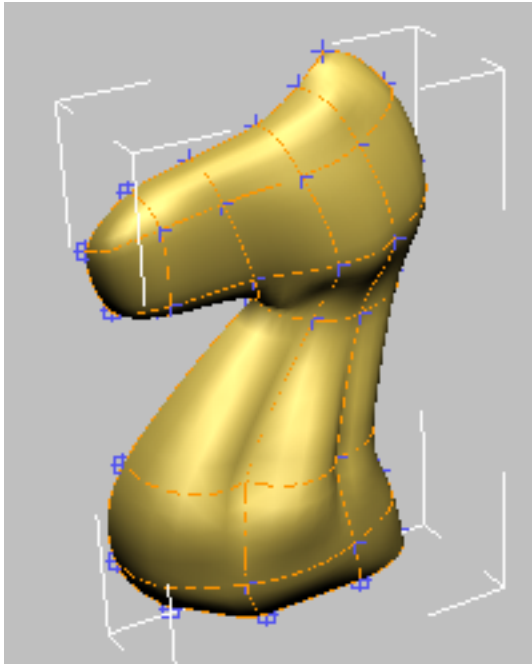

Refine the mane line:

- 1 Adjust the Perspective viewport so that you are looking at the back of the neck.
- 2 Using Connect/Refine, start from the vertex at the very top of the head and work your way down to refine a mane line as shown in the following illustration.

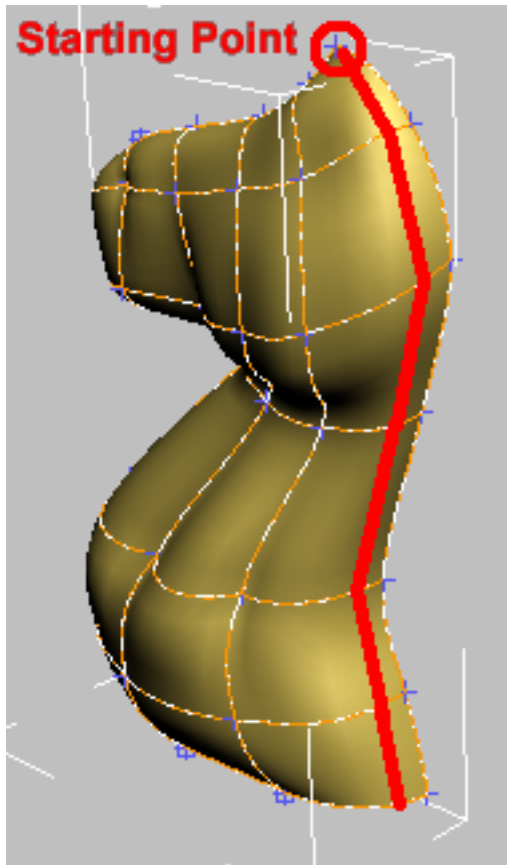

As you refine the segments, surface patches temporarily disappear from view but reappear once you finish the command. This is because you are introducing additional vertices and this creates patch areas that have more than four vertices. Once you are done refining the spline cage, however, the end result is made up of quads again and therefore displays correctly.

- 3 Exit the Vertex sub-object level and then click the Surface modifier to go to the top of the stack.

Mirror the spline arrangement:

- 1 If you haven't done so already, highlight the Surface modifier on the modifier stack.

- 2 From the Modifier list choose Symmetry.
- 3 On the Parameters rollout, set Mirror Axis to Z.

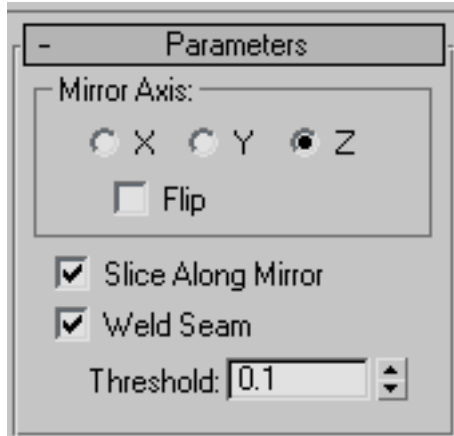

- 4 Orbit around the object in the Perspective viewport to see the full 3D object.

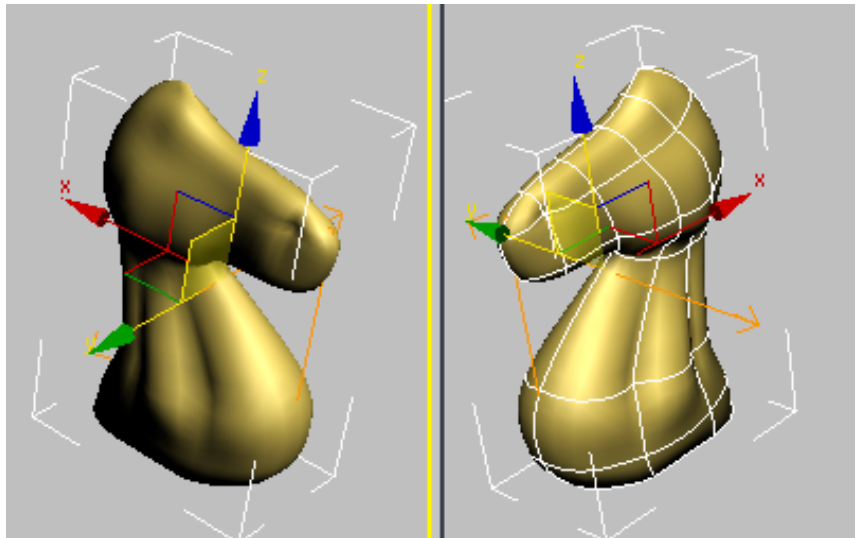

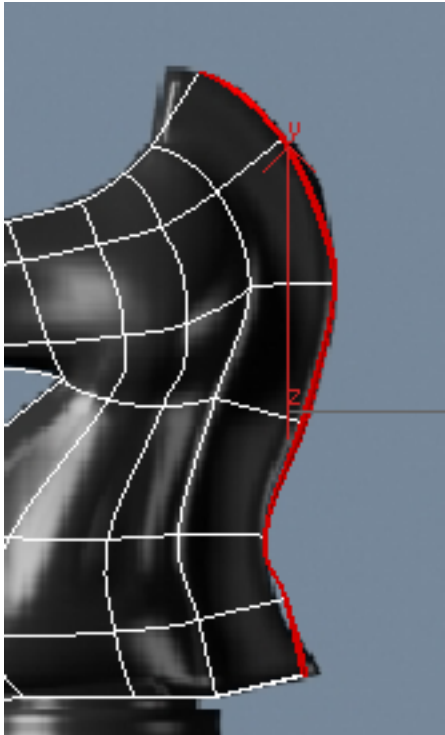

-  On the Selection rollout, switch from Patch to Vertex and turn on Show End Results.
Because of the direction of the extrusion, you need to adjust the vertex position to give the Symmetry modifier a little help.

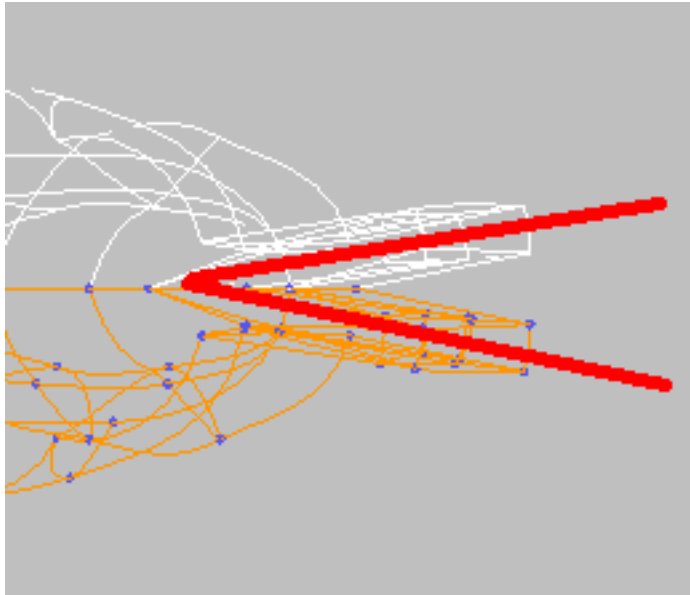

- 8 In the Front viewport, use region selection to select all vertices on the outer edge of the mane. Use the Ctrl key if necessary.

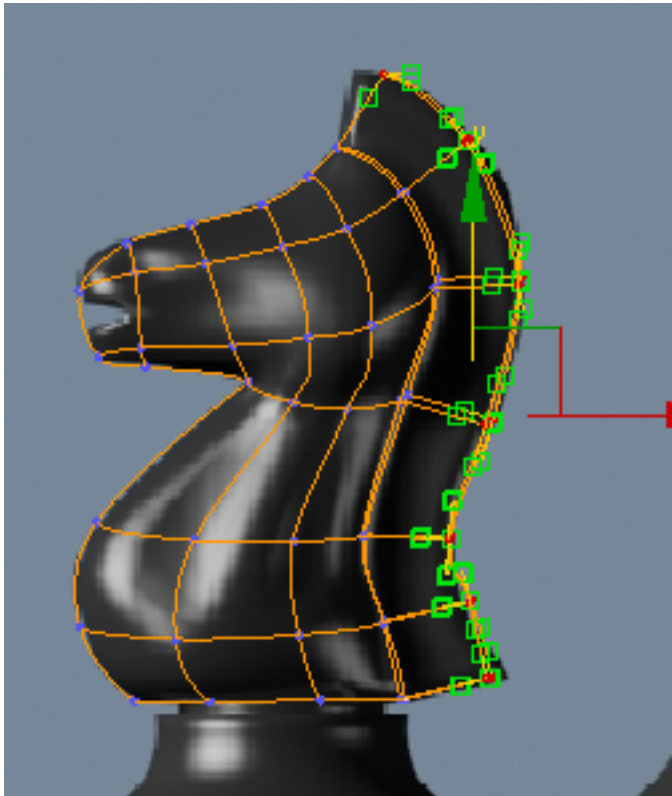

- 9 In the Top viewport, move the selected vertices up until they intersect along the mirror line. Keep an eye on the other viewport to see if the Symmetry modifier worked nicely to weld the seams.

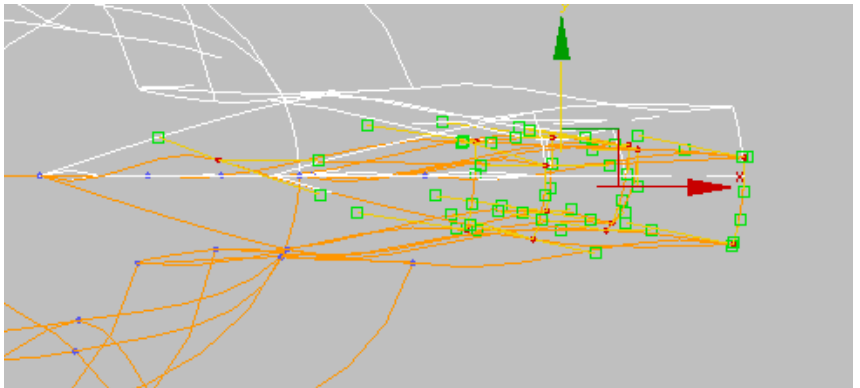

NOTE This was a rather simplistic way of adjusting the mirror line. Ideally, you want to move the vertices individually or in groups, while at the same time adjusting tangents for better effects.

- 10 Adjust the positions of the vertices and tangents in the Front viewport to follow the reference image and create a nicely flowing mane.

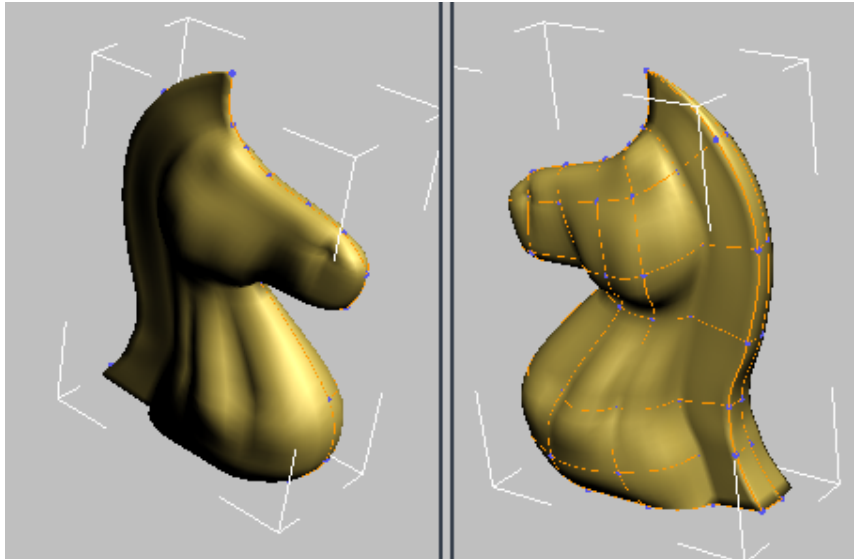

Create the base:

Even though you could have created the base as part of the same spline cage, it is easier to build it as a separate object and then attach the two objects together as a single mesh. The base is a simple lathed object, much like the ones you created in the previous lessons.

- 1 From the Create menu, choose Shapes > Line.
- 2 On the Creation Method rollout, set both the Initial Type and Drag Type to Corner.
- 3 In the Front viewport, click a point in the top center of the base, just below the knight.
- 4 Hold down the Shift key to constrain the line to the vertical direction, and then click a point at the bottom center of the base.

- 5 Move to the right and click a point at the bottom-right corner of the base.
- 6 Release the Shift key and go up the right side to create a rough profile of the base. Make sure you close the spline when you are done.

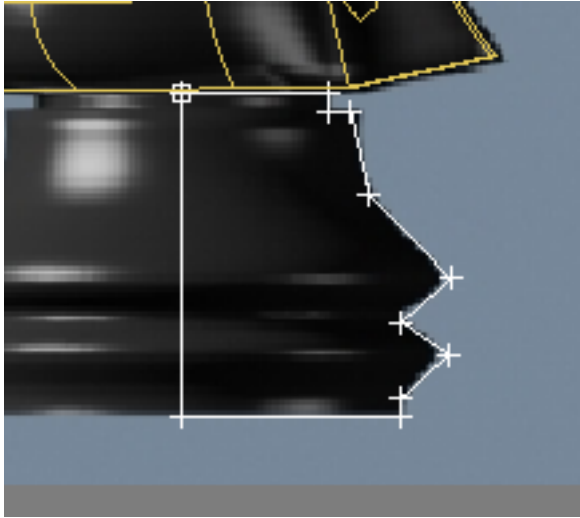

- 7 Go to the Modify panel. On the Selection rollout, choose Vertex.
- 8 On the Geometry rollout, choose Fillet.
- 9 Use the Fillet tool to round off the vertices that need it.

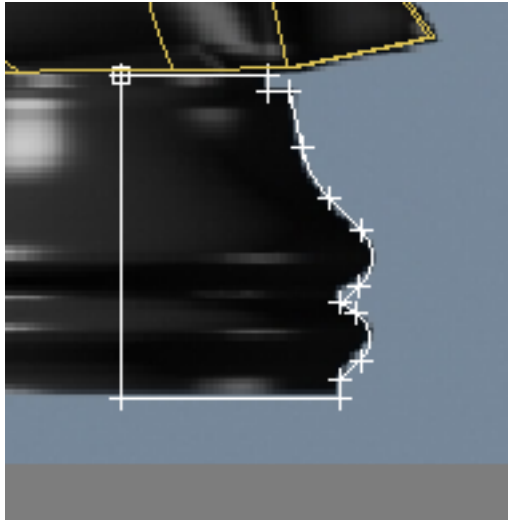

- 10 Exit the Vertex sub-object level.
- 11 From the Modifier list, choose Lathe.
- 12 Set the Segments to **32** and turn Weld Core. In the Align group, click Min.

NOTE If you need further detail on how to create a lathed object, refer to the first lesson in this tutorial: Modeling a Pawn.

Turn the two objects into a single mesh:

- 1 Make sure the base is still selected. Right-click it and from the quad menu, choose Convert to > Convert to Editable Mesh.
- 2 On the Edit Geometry rollout, click Attach and then click on the knight in any viewport.
- 3 Change the object's name to **Knight**.

The knight is now complete, unless you want to add a mouth, which you can do by using Refine to add vertices, and then moving the vertices.



Summary

In these lessons, you created four chess pieces, learning different tools and methods in each case. Creating a pawn taught you about working with splines and the lathe modifier. Creating a bishop and a rook taught you about editing geometry and using Boolean compound objects to add or subtract components. Finally, you learned to model using a spline cage approach using the Surface modifier with spline objects.

Modeling an Airplane

In this tutorial you will create the exterior of a classic, WWII airplane, the Lockheed P-38 Lightning. You'll use primitive objects and modifiers to create the parts. Viewport background bitmaps will act as guides to help you shape your plane.



Lockheed P-38 Lightning model

In this tutorial, you will learn how to:

- Set up the viewports with background images to help in building the model.
- Use primitive objects as the basis for each part of the airplane.
- Edit the model at sub-object levels.
- Adjust the pivot point and hierarchy of the model in preparation for use with a game engine.

Skill level: Beginner to Intermediate

Time to complete: 1 hour 30 minutes

Setting Up the Airplane Scene

The first task is to set the modeling units to meters and create a calibration box. Aircraft designers have always used the metric system for specifying dimensions. As a default, 3ds Max is set to generic units, so you'll need to change this.

Set up units of measurement:

- 1 From the Customize menu, choose Units Setup.
The Units Setup dialog appears.
- 2 Choose Metric, then click OK.
Now when you create anything, the dimensions will be displayed in meters.
- 3  In the Create panel, on the Object Type rollout, click Box.
Look at the Parameters rollout; the size values are now displayed in meters.
The next step is to set up the viewport backgrounds.

Build the calibration box:

An actual P-38 has a wingspan of 15.85 meters, and a length of 11.532 meters. With the wheels extended, it has a height of 3 meters. You'll use this information to make a box of that size so you can get an idea of how much space the model will take up.

- 1 Activate the Top viewport.



- 2 In the Create panel, on the Object Type rollout, click Box.
The Box button turns gold to show it's active and ready to create.
- 3 Open the Keyboard Entry rollout, and enter the following values (you needn't type the "m"; 3ds Max adds it automatically when you press Enter or Tab):
 - Length: **11.532m**
 - Width: **15.85m**
 - Height **3m**

TIP You can use the Tab key to move from one field to the next.

- 4 Once these values are entered, click Create.
A box appears in the viewports.
- 5 In the command panel, name the object **calibration box**.

- 6  In the viewport navigation controls at the bottom-right corner of the interface, click Zoom Extents All. The box is now visible and centered over the three background bitmaps. It doesn't matter if your box is a different color than the one in the illustration.

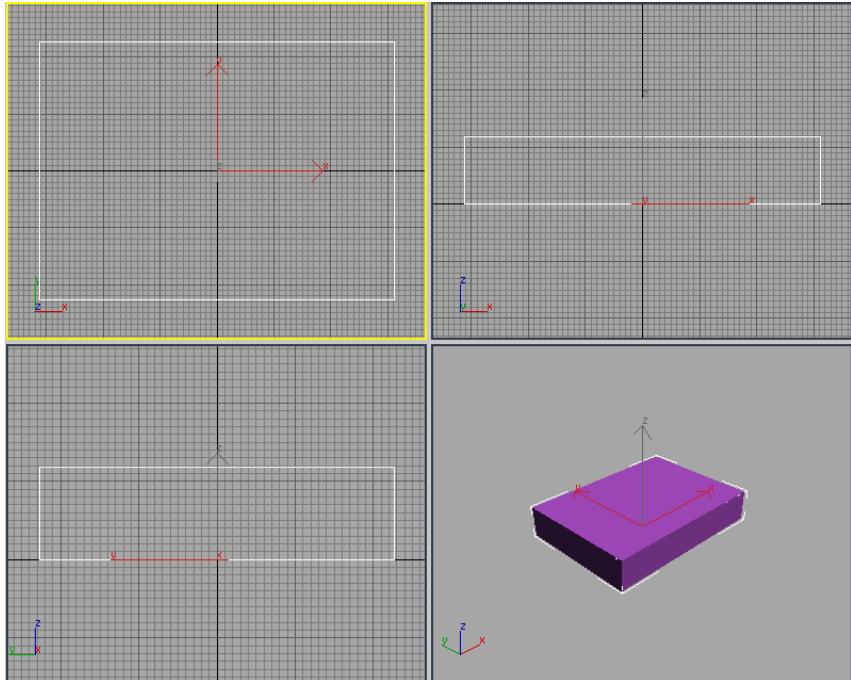

The calibration box.

Setting Up Viewport Backgrounds

You can load images or drawings in viewport backgrounds to use as patterns for building your airplane. Each viewport can have its own background, so you can load a corresponding image in the Front, Side, and Top viewports to guide you as you build your model.

In general, when modeling something you've previously visualized or seen, it's best to start with sketches from several different viewpoints, such as top,

side, and front. Also, the drawings should all be to the same scale, if possible. In this lesson, you'll use three drawings of a P-38 Lightning taken from WWII plane-spotting cards.

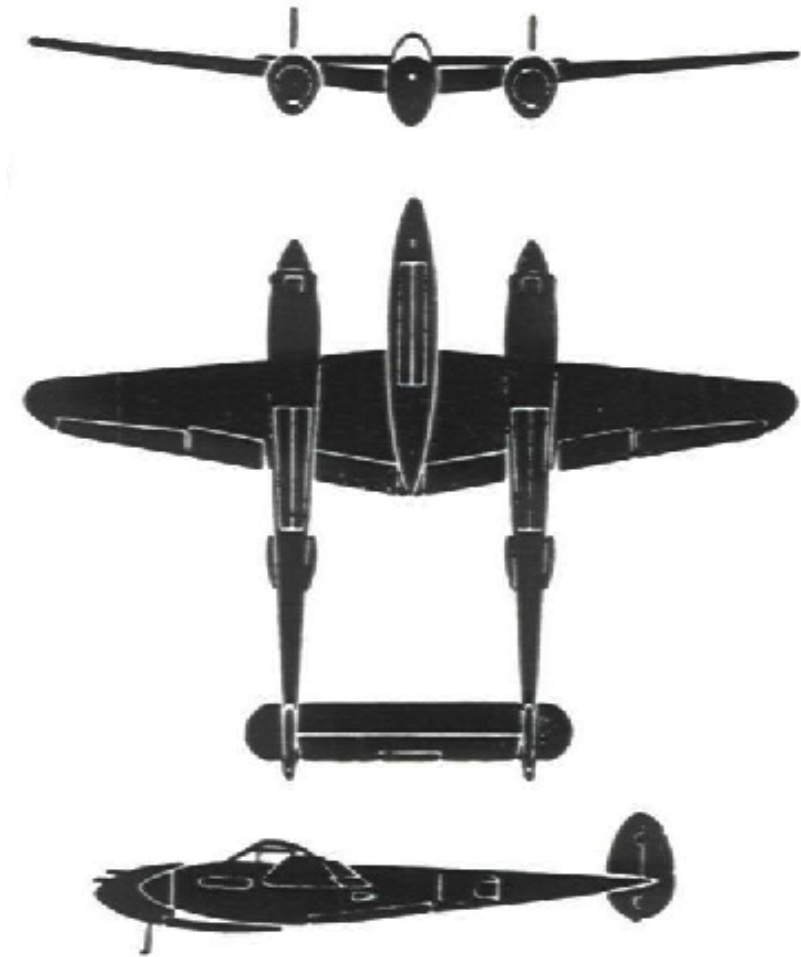

Three views of the P-38 Lightning from a set of plane-spotting cards

Set up viewport backgrounds:

- 1 Move your cursor to the Top viewport and right-click to make it active.

- 2 On the menu bar, choose Views > Viewport Background.

TIP You can also use the keyboard shortcut: Alt+B.

- 3 In the Viewport Background dialog's Background Source group, click Files.

- 4  On the Quick Access toolbar, click the New Scene button, navigate to the \sceneassets\images folder and choose *p38topview.jpg*. Click Open.

- 5 In the Aspect Ratio group, choose Match Bitmap. Click OK.

A sketch of the top view of the fighter is visible in the Top viewport and the Viewport Background dialog closes.

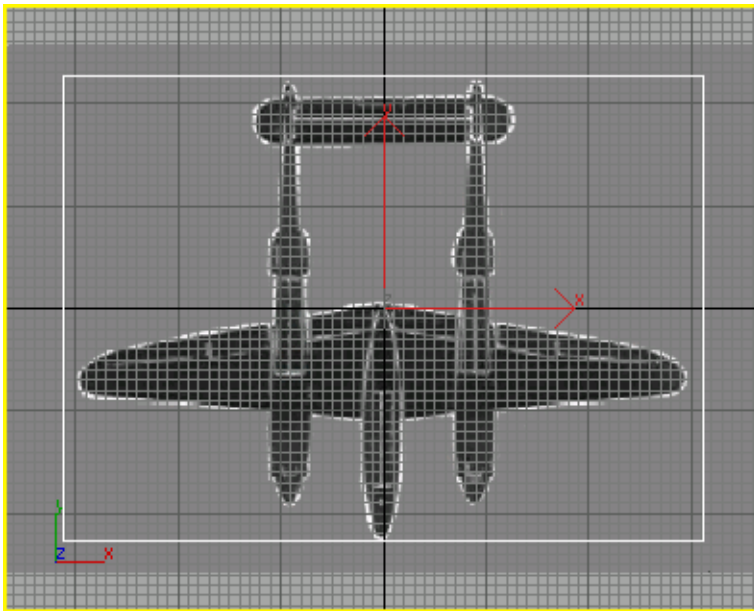

Top viewport displays the Top view background image.

- 6 Turn off the grid display by pressing the G key.
- 7 Choose Views > Viewport Background to again open the Viewport Background dialog.
- 8 At the lower left, click the arrow by the Viewport field, and choose Left. The Left viewport becomes active.

- Click Files and choose *p38leftview.jpg* for the Left viewport. Again, choose Match Bitmap. Click OK. Turn off the grid display again.

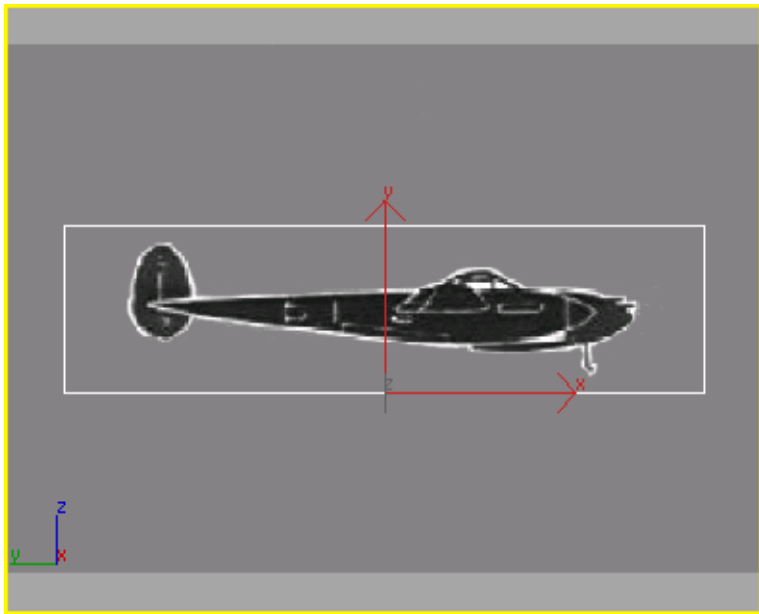

Left viewport with its corresponding background image.

- Right-click in the Front viewport and press Alt+B to open the Viewport Background dialog again. Click Files again and choose *p38frontview.jpg* for the Front viewport. Choose Match Bitmap, then click OK. Turn off the grid display.

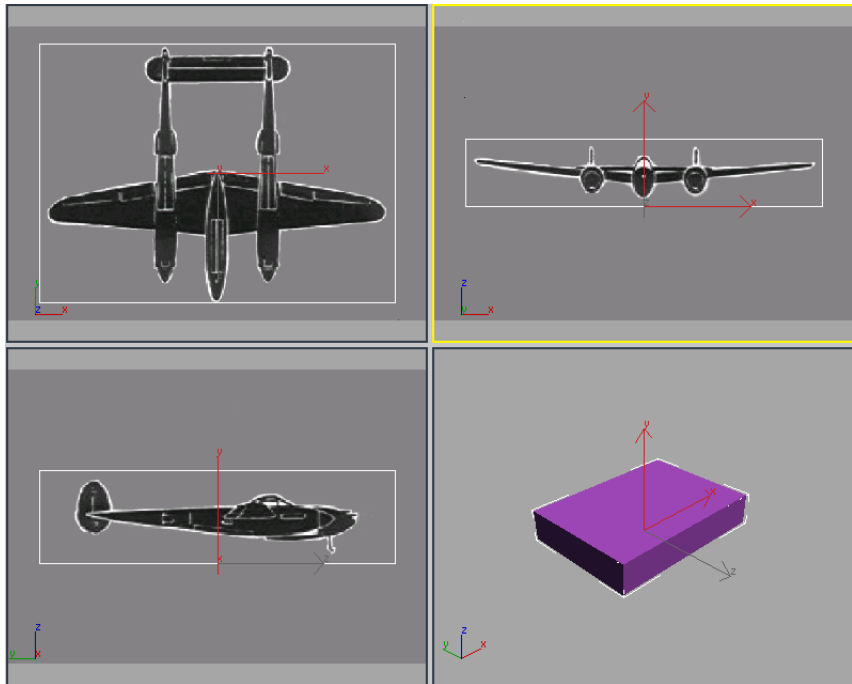

The three images are displayed in their appropriate viewports.

Next you will zoom and pan each view to more closely match the background images to the calibration box to make sure the three viewports are in the same scale. Each image is currently centered within the calibration box.

Calibrate the viewports:

- 1 Activate the Top viewport.



- 2 In the viewport navigation controls, at the lower right, click Zoom. Zoom the Top viewport until the width of the box matches the width of the wings. Match the wingspan as closely as you can.



- 3 Click Pan in the viewport controls, and then pan the viewport to center the box over the bitmap vertically. It won't be perfect, the two rudders will extend slightly beyond the calibration box.

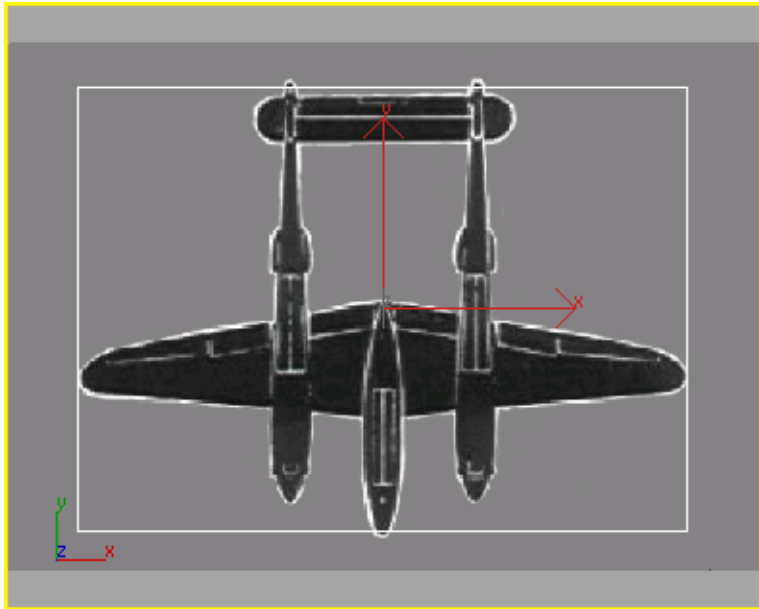

Top viewport aligned with calibration box

- 4 Zoom the Front viewport. Again match the wingspan first using zoom, then pan to adjust the vertical height. Since the landing gear is not shown in the plane-spotting card, align the top of the box with the tops of the rudders.

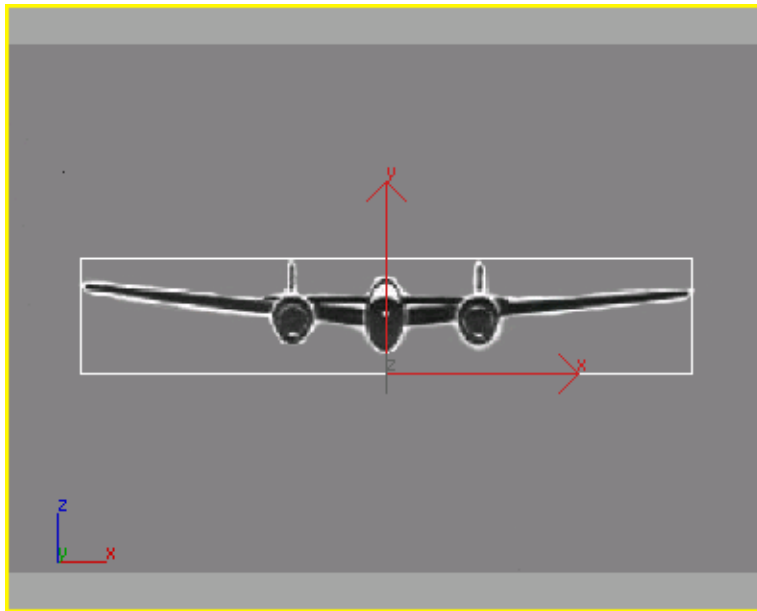

Front viewport aligned with the calibration box.

- 5 Now repeat zooming and panning in the Left viewport.

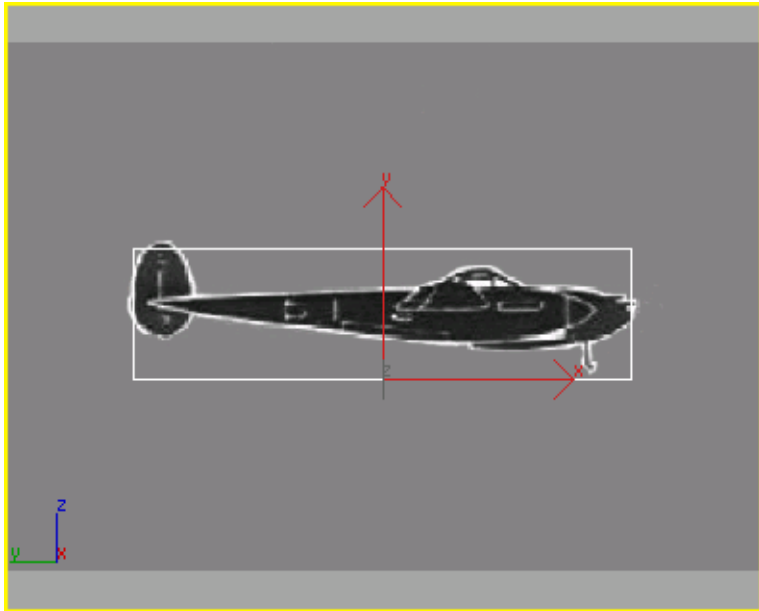

Left viewport aligned with calibration box

All three viewports are now calibrated so the picture in the viewport represents the approximate dimensions of the P-38.

You can zoom and pan the background images in the viewport if you want to center or enlarge them. To zoom or pan the background images do the following:

Zoom the background images and calibration box:

- 1 Activate the Top viewport, then choose Views > Viewport Background.

- 2 Turn on Lock Zoom/Pan.

Turning on Lock Zoom/Pan locks the background image and objects together, so if you use the zoom or pan buttons from the viewport navigation controls, you can zoom in on the background image and objects or shift them horizontally or vertically.

This is very handy if you have a detailed background sketch and know you will be zooming in to work on objects.

- 3 Repeat this for the Left and Front viewports.

You will notice the background image shifts when you close the Viewport Background dialog.

TIP Sometimes the background image can shift out of alignment with your geometry. This is inconvenient, but there is a workaround.

If you open a saved file or notice the background image has shifted, do one of the following:

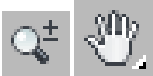
-  Use the viewport navigation Zoom and Pan buttons to make the background images the correct size and position in the viewports. Turn off Lock Zoom/Pan, and then use the same navigation tools to align the geometry with the bitmaps. You can use Ctrl+Alt+B to toggle Lock Zoom Pan.

-  You can also move the objects in the scene to match the background image. Then, if you use Zoom Extents, the image will be centered with the geometry.

Hide the calibration box:

- 1 You don't need the calibration box now, so you can hide it. To do so, select the box in any viewport, right-click, and then choose Hide Selection from the quad menu.



You can always unhide the calibration box and repeat the above procedure to re-calibrate. To unhide the box, go to the Display panel and choose Unhide By Name, then in the dialog, select the box.

- 2 Save your work as **myp38_backgrounds.max**.

Creating the Wings

There are many different modeling approaches you could take to building the wings. Here, you'll use a Box primitive with a Taper modifier.

You'll be continuing from the previous section, [Setting Up Viewport Backgrounds](#) on page 128 or open *p38_calibrated_start.max* from the *\modeling\p38_lightning* folder.

Create the wing using a box:



- 1 On the Create panel, on the Object Type rollout, click Box.
- 2 In the Top viewport, do the following to draw a box from upper left to lower right, approximately around the front wingspan:
 - Click once at the upper left, then drag to the lower right with the mouse button down. As you move the mouse, the values for length and width change in the parameter fields.
 - When you release the mouse button, you have set the length and width of the box, and now are setting the height, which you can see increasing in the Perspective viewport. Moving the mouse up creates a positive height, moving down creates a negative height. As you move the cursor the values change in the parameter fields.
 - Click again to set the height.
- 3 On the Create panel, you can immediately adjust the values in the Parameters rollout. Enter the following values:
 - Length=**3.048m**
 - Width=**15.85m**
 - Height=**0.305m**
 - Length Segs=**3**
 - Width Segs=**12**
 - Height Segs=**3**

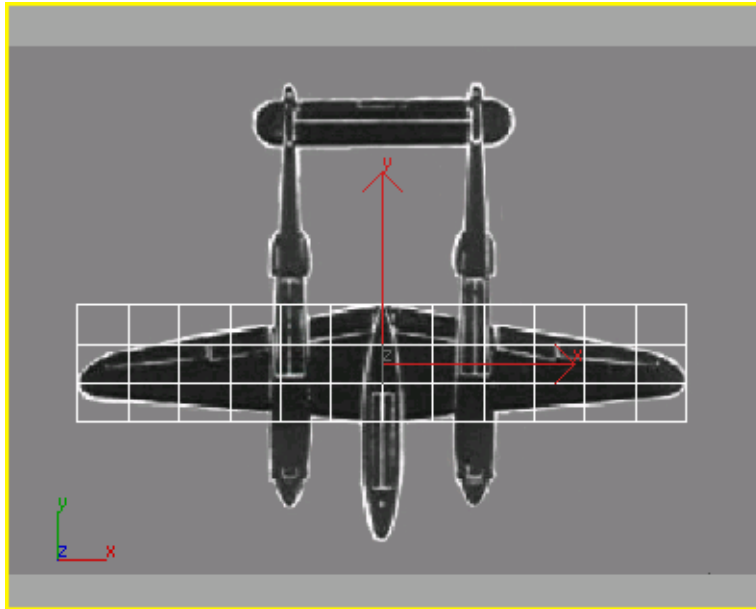

The Box with 12 width and 3 length segments.

You need to increase the number of segments so the modifiers for tapering and bending the wings will work correctly.

- 4 In the Name and Color rollout, type **wing**.

The object is now named *wing*.

Next you'll change the shape of the wing's profile so it looks like an airfoil.

Shape the wing into an airfoil:

- 1 Activate the Left viewport, and make sure the wing is selected.



- 2 From the viewport navigation controls, click Zoom Extents.

You'll zoom in on the wing object.

- 3 From the menu bar, choose Modifiers > Mesh Editing > Edit Mesh.

You'll need this to perform some sub-object editing to the vertices that make up the wing.

- 4  In the Selection rollout, click the Vertex button.

Look at the box in the Left viewport with vertex selection on. Each tick you see is actually twelve vertices lined up on top of one another. When you want to select and move them, you need to drag a selection window around them. Otherwise you will only select one vertex, rather than all of them.

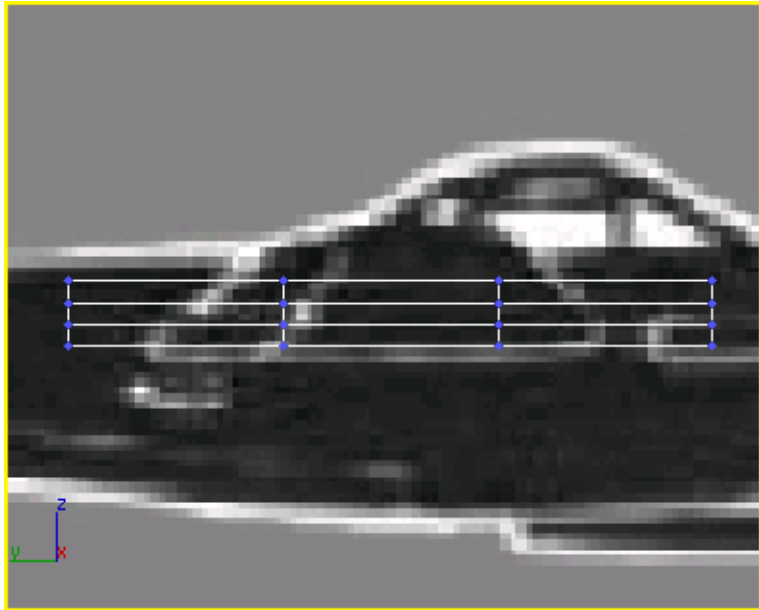

The vertices appear as blue ticks at every intersection of the model.

- 5 Draw a selection window around the upper right set of vertices.
The X,Y,Z tripod jumps to the selection set and the selected ticks turn red.

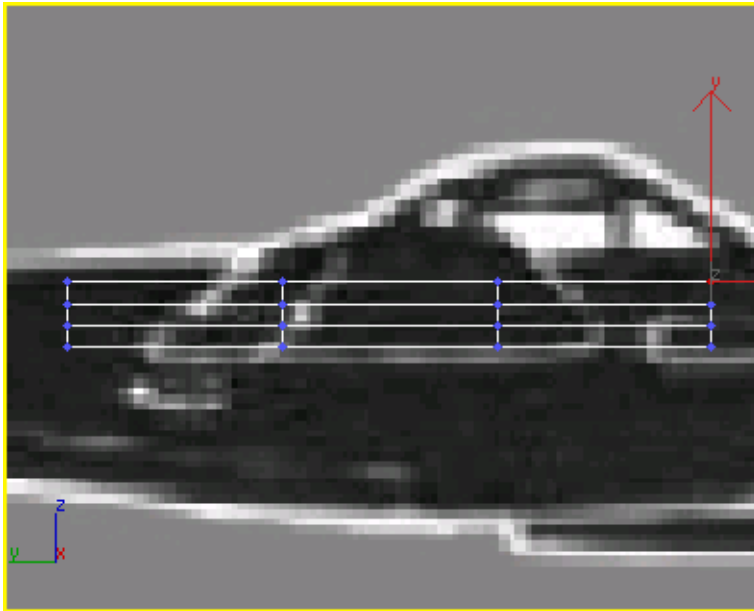

Selected vertices display in red.

- 6 Hold down the Ctrl key and drag a selection window around the vertices at the lower right.
The Ctrl key allows you to add to an existing selection set. The X,Y,Z tripod jumps to the center of the selection set.

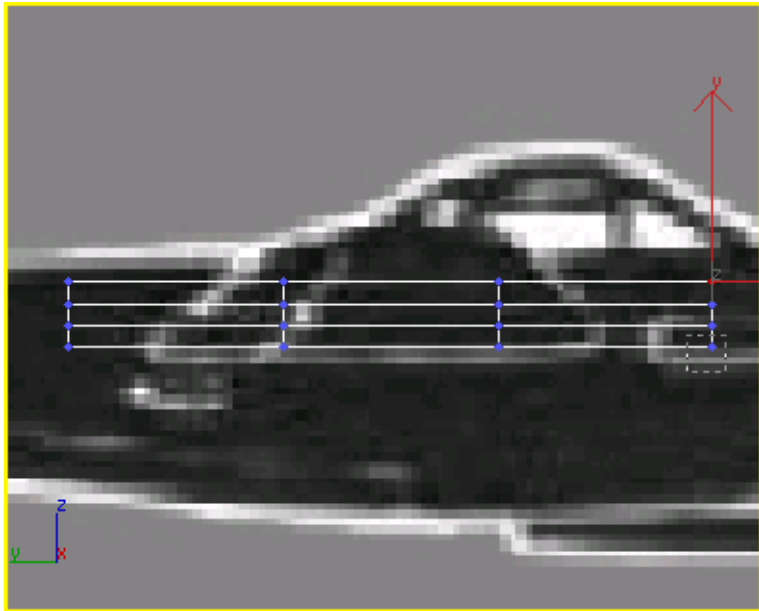

On the main toolbar, click the Select and Move button and move the cursor over the X axis of the tripod. Click and drag the cursor to the left so the leading edge of the wing looks beveled.

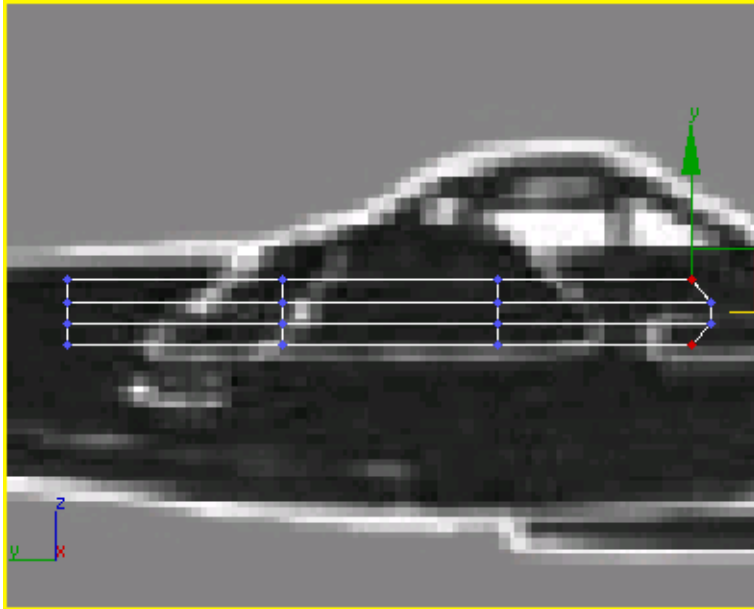

- 7  Click Select And Non-Uniform Scale. Then scale the vertices along the Y axis to 75%.

TIP Watch the Y field of the coordinate read out at the bottom below the time slider.

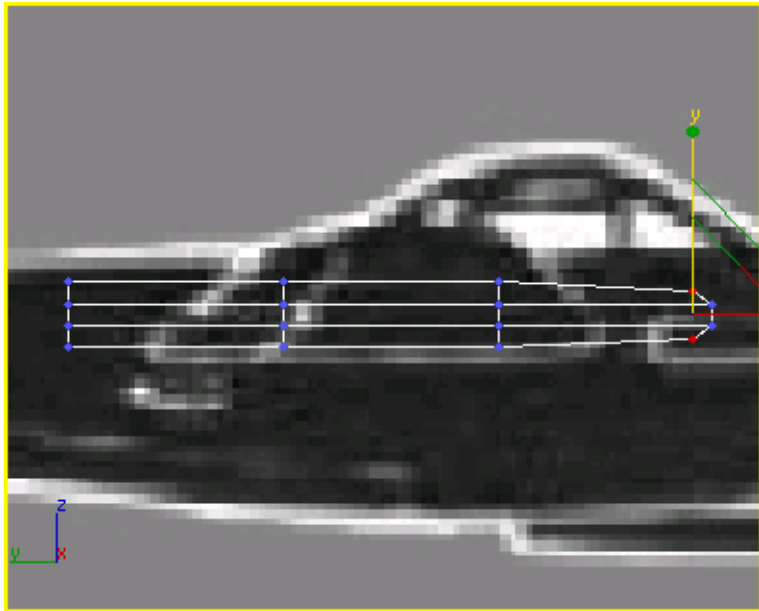

Scale the vertices to start rounding off the leading edge of the airfoil.

- 8 Drag a selection window around all the vertices in two center columns of vertices.

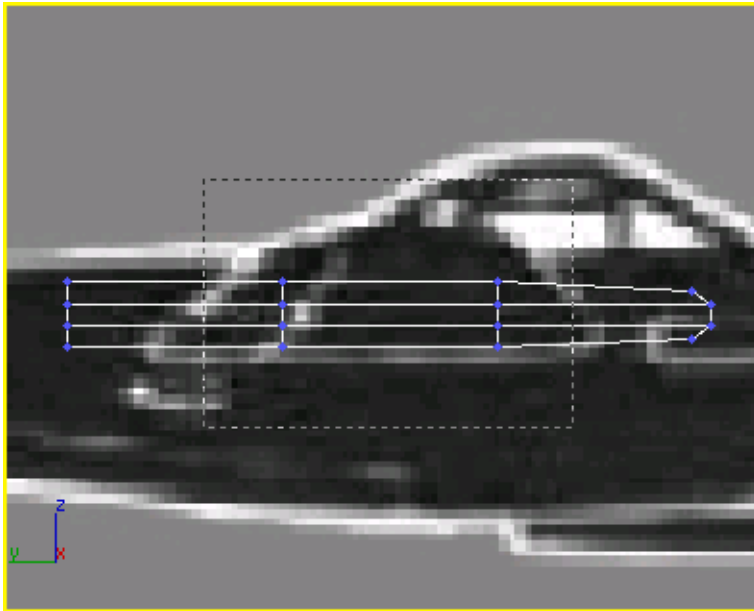

- 9  Move this set of vertices along the X axis to the right about 0.5m. Again, watch the coordinate readout at the bottom.

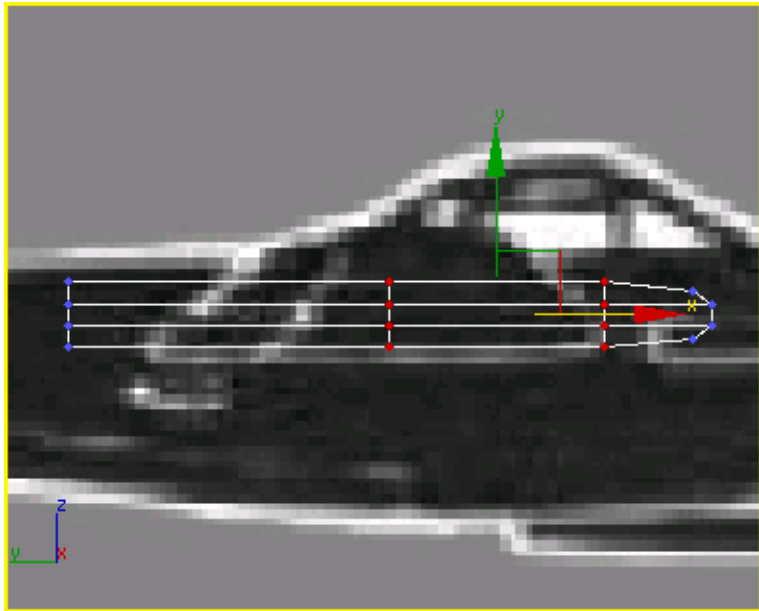

- 10 Drag another selection window around the vertices at the upper left corner. Then hold the Ctrl key and drag a selection window around the vertices at the lower left corner.



- 11 Move this set of vertices along the X axis to the right about 0.8m.

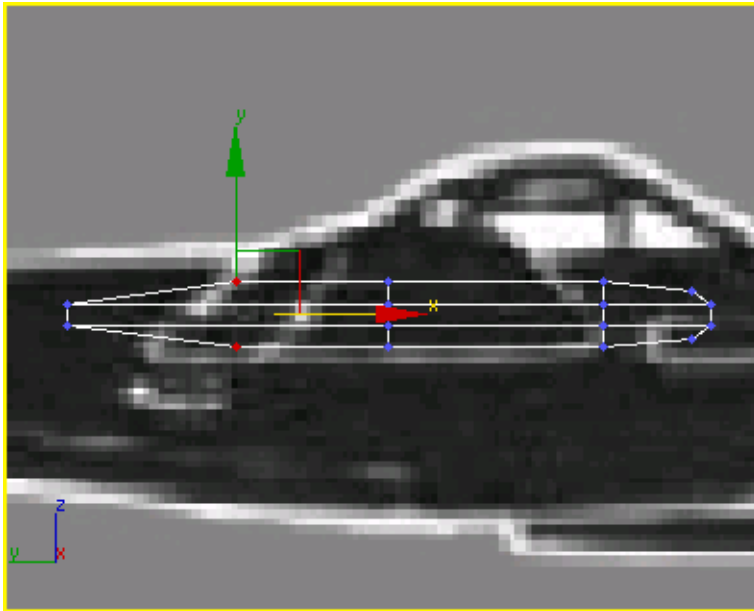

The airfoil is beginning to take shape.



- 12 Click Select And Non-Uniform Scale, hold down the Ctrl key and drag a selection window around all the left-most set of vertices.

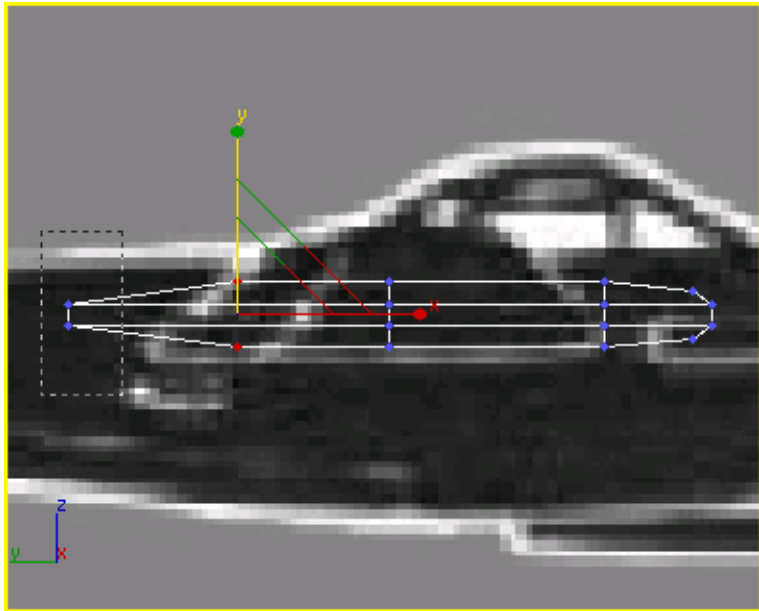

13 Scale this selection set along the Y axis to 75%

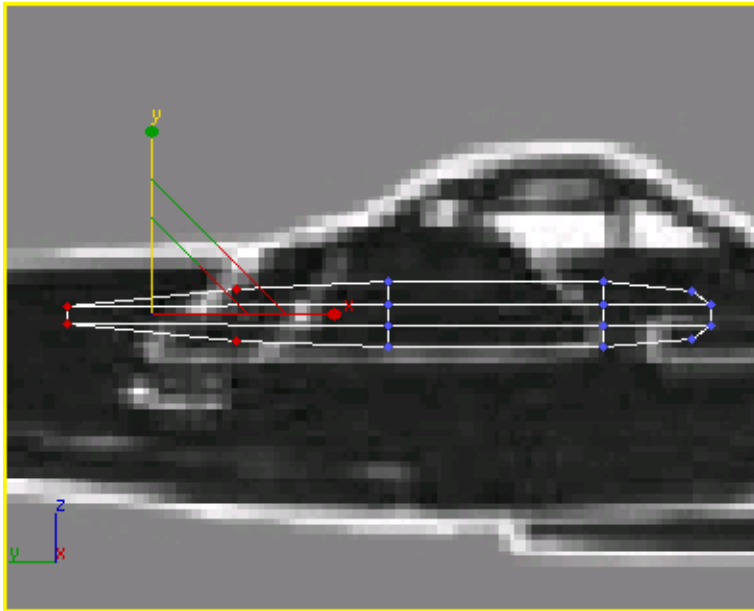

Now you've got a pretty good approximation of an airfoil.

Now that you have your airfoil, you'll make further changes to the shape of the wing using a Taper modifier.

Add a taper modifier:

- 1  Activate the Top viewport, and make sure to turn off Vertex mode.
- 2 From the menu bar, choose Modifiers > Parametric Deformers > Taper. An orange taper gizmo appears in the viewport over the box.
- 3 On the command panel, in the Taper Axis group, change the Primary value to **X**.
- 4 In the same group, turn on Symmetry.
- 5 Set the amount of the taper to **-1.3**.

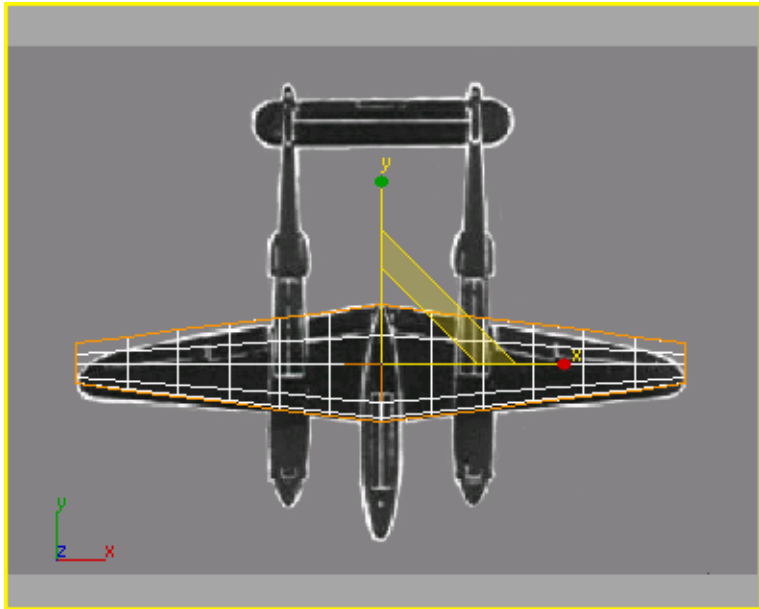

The box is starting to resemble the P-38's wing shape.

Next you'll move the Taper Center to refine the wing's shape.

- 6  In the modifier stack display, expand the Taper hierarchy by clicking the box marked with a plus sign. When the Taper expands, click Center.

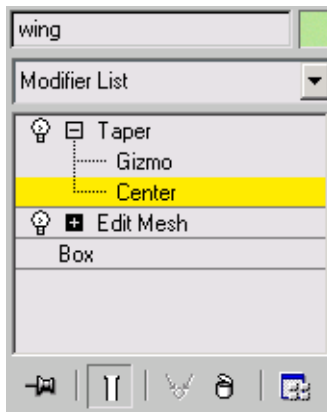

At the Center sub-object level, you can adjust the location of the center of the Taper. Moving a modifier's center will alter its results.

- 7 In the Top viewport, move the center of the taper forward along the Y axis toward the nose of the plane, until the wings' shape more closely matches the background image.

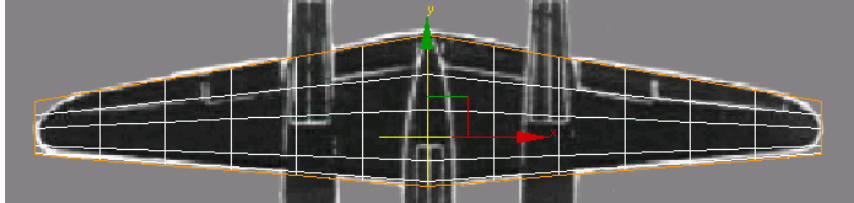

- 8 When you've finished moving the center, click Taper in the modifier stack to turn off the Center sub-object selection.
- 9 The Taper has affected the height of the wings. In the modifier stack, click Box, then increase the wing height to **0.4318m**.

NOTE Because you're making a change that affects a topology-dependant modifier, Edit Mesh, you'll see a warning. Click Yes to make the height change. If you're not sure, click Hold/Yes. Hold/Yes creates something like a clipboard copy of the entire scene. If the change you make is undesirable, use Edit menu > Fetch to restore the scene to its state before you made the change.

- 10  Activate the Front viewport and move the wing along the Y axis so it is centered over the background bitmap.

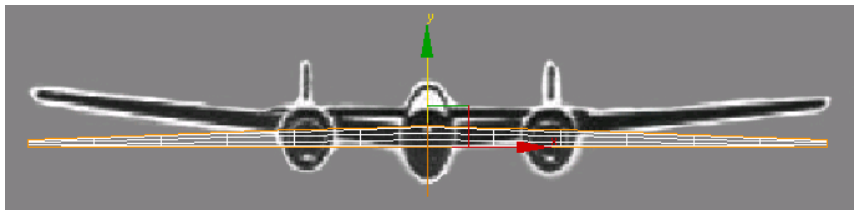

Move the wings up in the Front viewport.

Next you'll convert the box to an editable polygon object, and then move some vertices to round off the wing tips.

Convert the box:

- 1 Save your file as **myp38_wing.max**.

TIP Get in the habit of saving your scene frequently at key points. Saving before converting the box is a good time, because the conversion removes the stack parameters. If, at a later time, you find that you have to make further adjustments to the Box geometry or Taper modifier, you can reload the saved model.

- 2 In any viewport, select the box, if it's not already selected.
- 3 Right-click and choose Convert to: > Convert to Editable Poly.
The box is now an editable poly object.

Round off the wing tips:

- 1  On the Selection rollout on the command panel, click Vertex. Some vertices from previous operations are already selected.
- 2 In the Top viewport, draw a selection window to select the vertices in the upper-left corner of the wing. While holding down the Ctrl key, drag another selection window around the same set of vertices at the opposite wing tip.

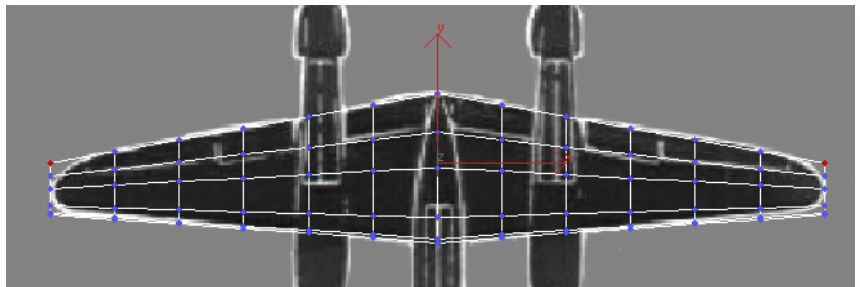

Select the vertices at each end of the wing.

- 3  On the main toolbar, click Select And Non-Uniform Scale. Then use the Transform gizmo to scale the vertices in the top view so the ends of the wing tips are rounded.

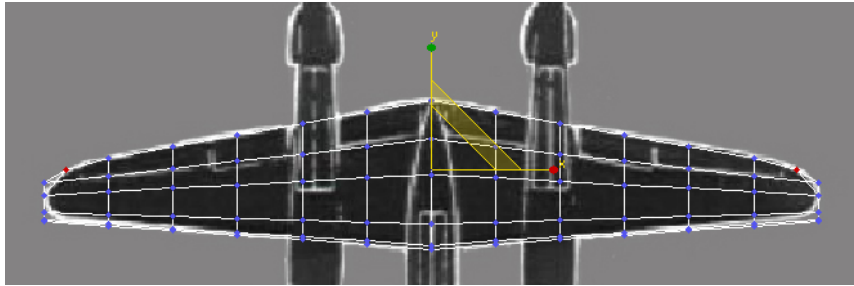

Scale the vertices to round off the wing tips.

- 4 Repeat the vertex selection and scaling until the wing tips are rounded.

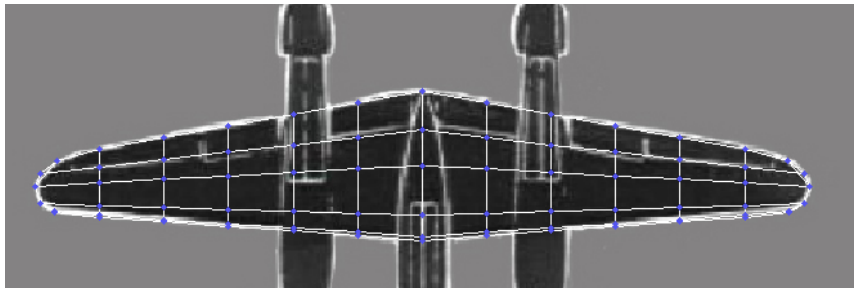

The wing tips are rounded.

In the Top viewport you need to select all the vertices on the outside edges of the wings. You can accomplish this by using the selection rectangle with the Ctrl key.

Add a Bend modifier:

- 1 In the Selection rollout, click Vertex to turn it off.
- 2 Click the arrow to the right of the Modifier List. In the drop-down list, find the Object-Space Modifiers group, and choose Bend.
- 3 Set the Bend Axis to X.
- 4 Change the Bend Angle to **-20**.

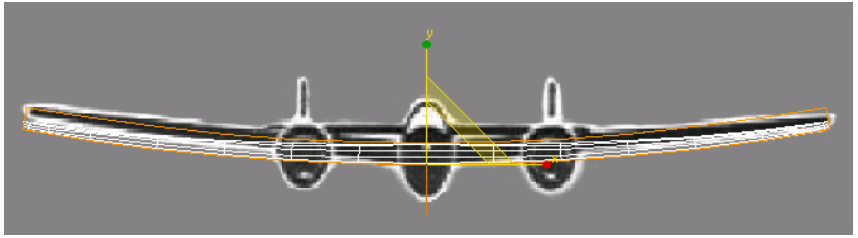

Bend the wings up.

- 5 Just for fun, spin the Direction spinner. Watch the wings stroke in the air. Right-click or press Ctrl+Z to undo when you're done having fun.
- 6 Save your work as **myp38_wing2.max**.
Next, you'll add the stabilizers and rudders. These are easy to do.

Adding the Stabilizer and Rudders

Continue from the previous lesson, [Creating the Wings](#) on page 136 or open *p38_wing.max* from the `\modeling\p38_lightning` folder.

In this lesson, you'll add the horizontal stabilizer and the twin rudders. You'll use cylinders and editable poly techniques to build these pieces.

Add the horizontal stabilizer:

- 1 Click the Top viewport to activate it.



- 2 From the Create panel, click Cylinder.
- 3 In the Top viewport, drag out the radius of the cylinder in the center of the horizontal stabilizer. When you release the mouse button, you then drag to set the height of the cylinder. Moving the mouse upward gives a positive height; moving it downward gives a negative height. Give it a positive height.

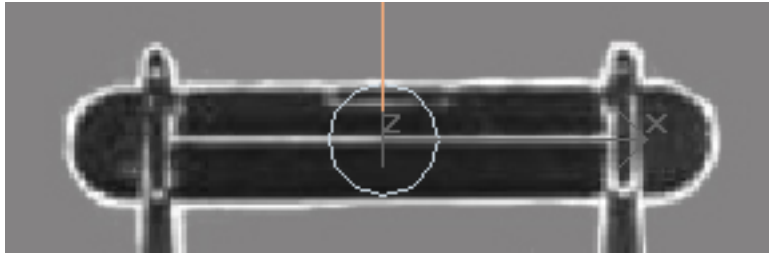

Create a cylinder to make the stabilizer.

4 Edit the Parameters, as follows:

- Radius=**0.66m**
- Height=**0.051m**
- Height Segments=**1**
- Sides=**14**

5 In the Name And Color rollout, type **stabilizer**.

Naming your objects proves useful later.

6 Right-click the cylinder and choose Convert to: > Convert to Editable Poly.

7  In the Modify panel, on the Selection rollout, click Vertex.
Now the vertices are visible in the cylinder.

8  Select half the vertices, and move them to the right. Select the other half of the vertices and move them to the left.

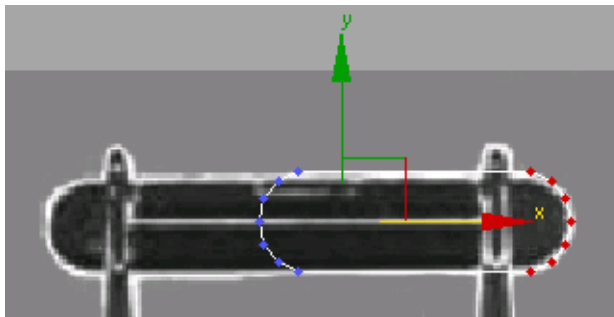

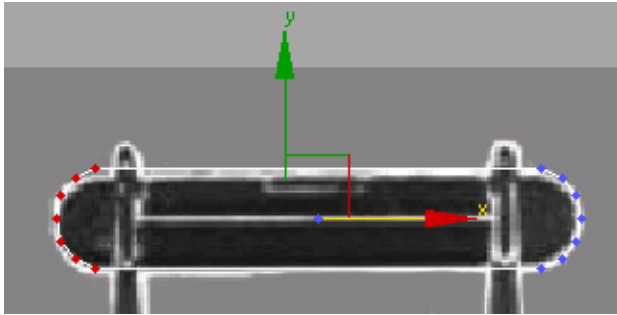

Move the vertices to match the top view of the stabilizer in the background image.

- 9  Click Vertex selection again to turn it off.

- 10  In the Front viewport, move the stabilizer up along the Y axis so it lines up with the background image.

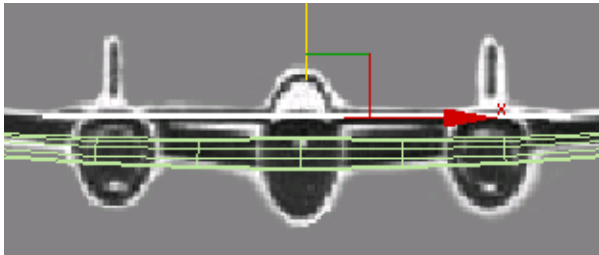

Align the stabilizer with the background image.

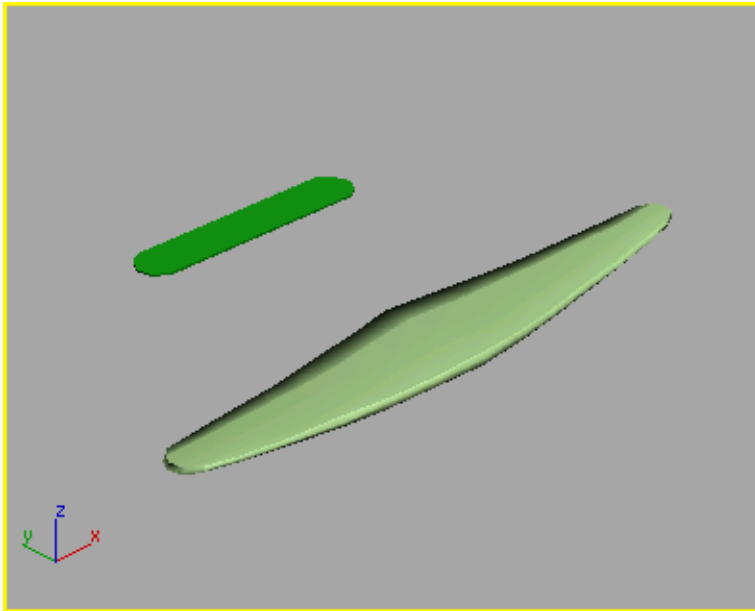



Wingspan and stabilizer in Perspective viewport

Next, you will construct the twin rudders.

Just like the stabilizer, you'll use a cylinder, converted to an editable poly object, to create one of the rudders. In this case, you'll use the soft-selection feature when you select and move vertices. After the rudder is properly shaped, you'll use the Symmetry modifier to create the second rudder.

Create the twin rudders:

-  1 Click the Left viewport to active it and click Zoom Extents if necessary.
-  2 On the Create panel, turn on Cylinder.
- 3 In the Left viewport, draw a cylinder over the rudder.

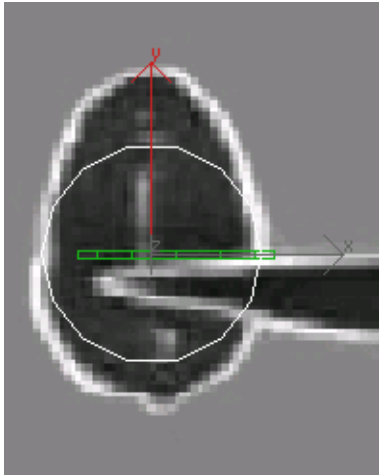

Start with a cylinder to make the rudder.

4 Set the following parameters:

- Radius=0.72m
- Height=0.051m
- Height Segments=1
- Sides=15

5 On the Name And Color rollout, enter the name **rudder**.



6 Click the Modify panel tab, and then right-click the Cylinder in the modifier stack. Choose Convert To: Editable Poly.

The modifier stack no longer shows the cylinder; it now shows Editable Poly instead.



7 In the Selection rollout, click Vertex.

8 In the Left viewport, drag a selection window around the top vertices.

Remember that there are vertices at the top and bottom of the cylinder, so even though a single red dot appears in the viewport, you are actually selecting two vertices.

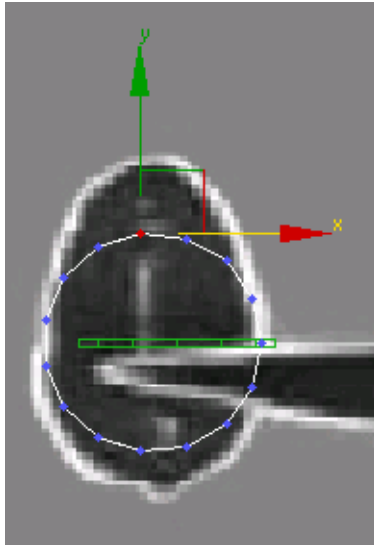

Select the top vertex.

- 9 Open the Soft Selection rollout, and turn on Use Soft Selection. Now the red dot is flanked by yellow-green dots.

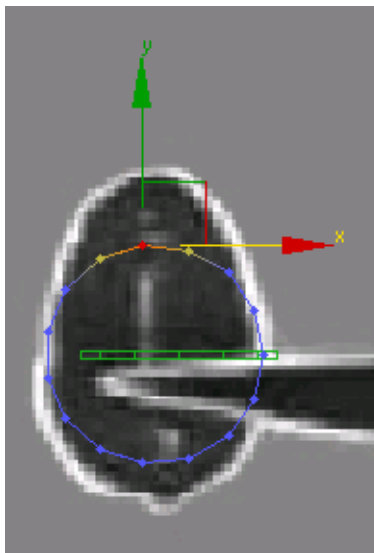

Soft Selection display

- 10 In the Soft Selection rollout, increase the Falloff value to **1.524m**.
The selection expands in the viewport.

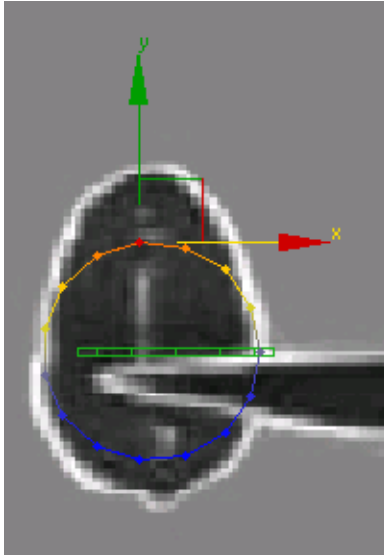

- 11 Using the Transform gizmo, move the selection upward to shape the rudder.

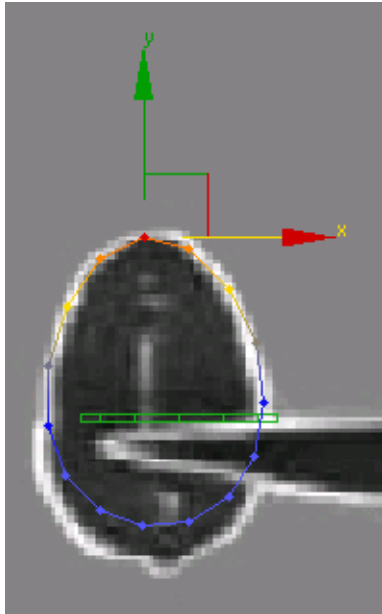

The rudder begins taking shape.

- 12 Select the bottommost vertex, and move it down to finish the shape.

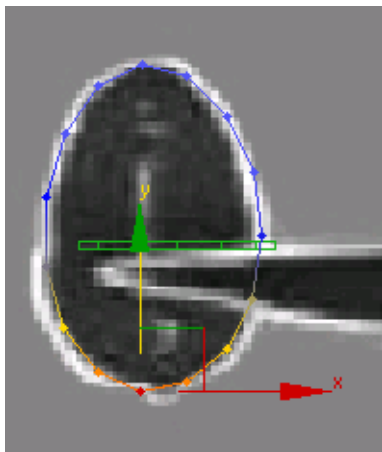



The rudder is fully shaped.

- 13 In the modifier stack, click Editable Poly to turn off sub-object selection.

- 14 In the Top viewport, select and move the rudder to the left into position.

Use Symmetry to create the second rudder:

There are several ways that you could create the second rudder but you'll use the Symmetry modifier for this part of the lesson.

- 1  Make sure the *rudder* object is selected and open the Modify panel.
- 2 Open the Modifier List and select Symmetry.
- 3 In the Parameters rollout, change the Mirror Axis to **Z**.
- 4  In the modifier stack display, expand the Symmetry hierarchy by clicking the box marked with a plus sign. When Symmetry expands, click Mirror.

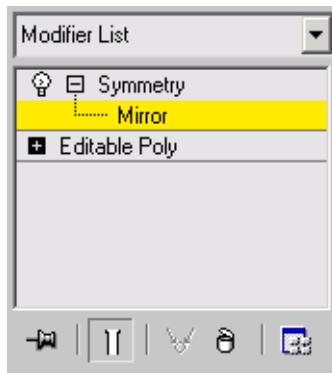

At the Mirror sub-object level, you can adjust the location of the mirror axis.

- 5 In the Top viewport, drag the Mirror gizmo to the center of the stabilizer. When the new rudder lines up with the background image, release the mouse button.

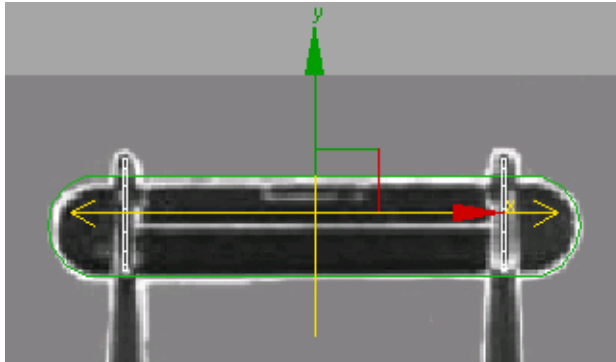

The new rudder

6 Click Mirror again to turn it off.

7 Rename the object **rudders**.

The Symmetry modifier adds geometry to an existing object. It does not make a clone of the original so both rudders are treated as a single object.

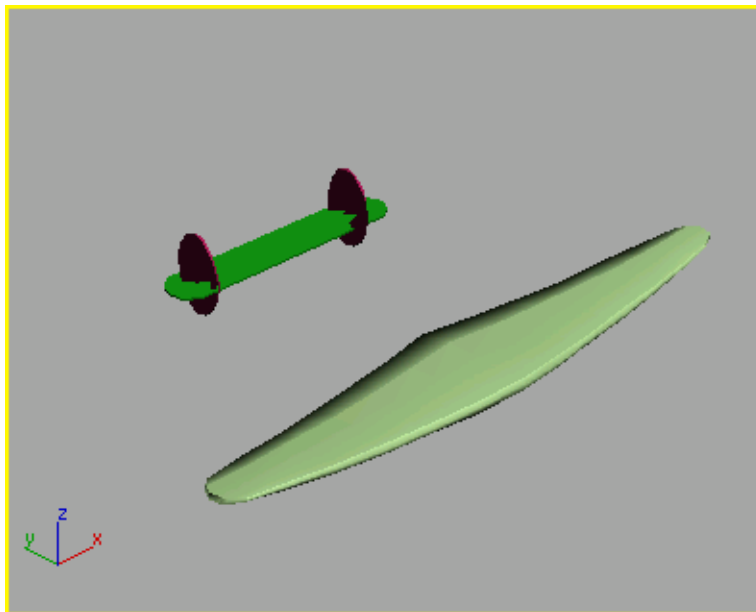

The completed tail section and wings.

- 8 Save your work as **myp38_wing_and_tail.max**.

In the next lesson, [Creating the Sponsons](#) on page 163, you'll create the sponsons that support the tail section and house the engines.

(Optional) Separate the rudders:

It's not really necessary, but if you want to separate the rudders, you can do so by adding an Edit Mesh modifier.

- 1 Open the Modifier List and apply an Edit Mesh modifier to the rudders.



- 2 From the Selection rollout, choose Element.
- 3 In the Top viewport, select the right-hand rudder.
- 4 From the Edit Geometry rollout, click Detach.
The Detach dialog appears.
- 5 In the Detach As field, enter the name **starboard rudder** and click OK.
- 6 Turn off the Element button and rename the selected object as **port rudder**.

Creating the Sponsons

The P-38 was a rugged aircraft because it had twin sponsons that supported the tail, housed the engines and superchargers and contained self-sealing fuel tanks. The airplane could sustain damage to either side, and still fly, thus presenting a formidable challenge to any opponent in a dogfight.

In this lesson, you'll model the sponsons using the same techniques you've already practiced on the wing and tail section. You'll also use the Bevel tools to create the engine exhaust gates.

Create the starboard sponson:

- 1 Continue from the previous lesson, [Adding the Stabilizer and Rudders](#) on page 153 or open *p38_wing_and_tail.max* from the `\modeling\p38_lightning` folder.



- 2 On the Create panel, click Cylinder.
The Cylinder button turns gold, showing it is active and ready to use.
- 3 In the Front viewport, drag a cylinder out over the left sponson so the radius approximates that in the background image.
Don't worry about the height, you'll adjust that in a moment. Drag the height to any value.
- 4 Edit the Cylinder parameters, as follows:
 - Radius=**0.558m**
 - Height=**10.0m**
 - Height Segments=**6**
 - Cap Segments=**1**
 - Sides=**12**
- 5 On the Name and Color rollout, change the name of the object to **starboard sponson**.



- 6 In the Top viewport, move the cylinder so it is over the sponson on left side of the background image (this is actually the right side of the plane, hence “starboard”). Position it so the rounded cap at the end, called the propeller spinner, is visible.

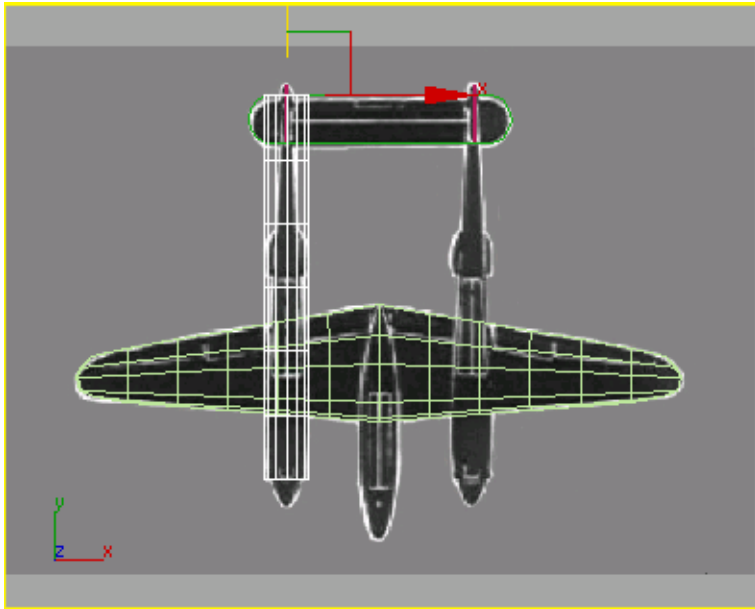

- 7  Go to the Modify panel. From the Modifier List, find the Object-Space Modifiers group, and choose Taper.
- 8 In the modifier stack, expand the Taper hierarchy so the Center and Gizmo are visible, then click the Center to select it.
- 9 In the Top viewport, move the center so it is at the front of the cylinder.

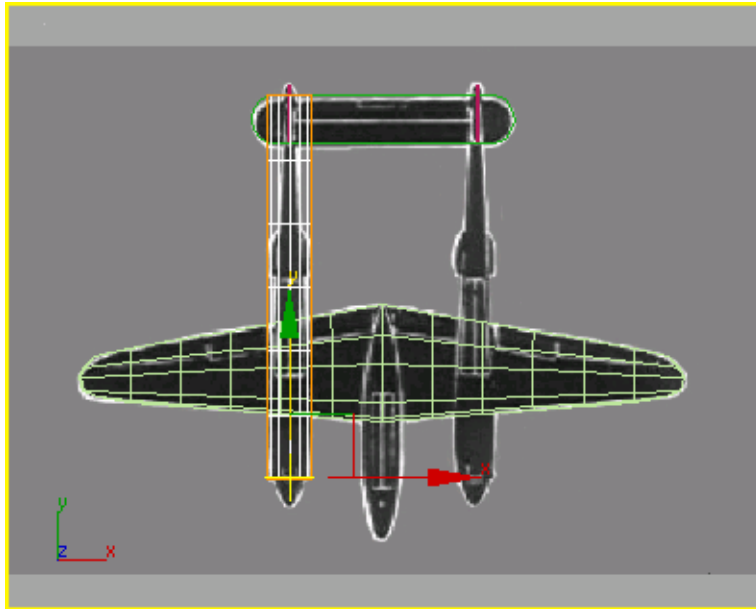

- 10 In the stack, click Taper to turn off sub-object selection.
- 11 Now adjust the taper Amount to **0.8**.

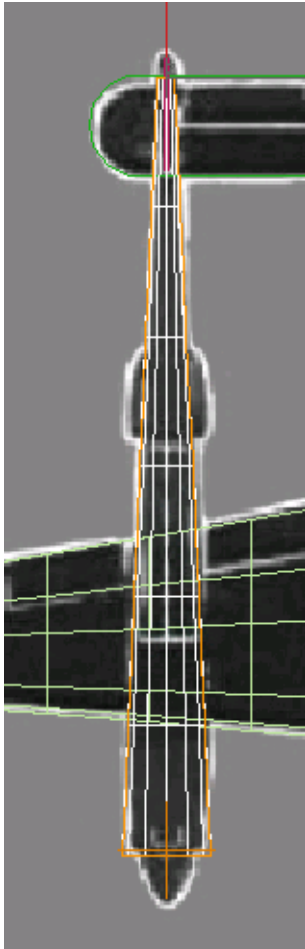

Tapered sponson aligned with the background image.

(The front of the sponson is just behind the propeller spinner.)

- 12  In the Front viewport, rotate the sponson about 15 degrees about its Y axis so the left and right sides are vertical.

TIP Alternatively, for greater precision you could enter **15** into the Y-coordinate field at the bottom.

Later in this lesson, you'll further shape the sponson by repeating the same technique as before: converting to Editable Poly, selecting rows of vertices, and moving them into position over the background image.

But first you'll create the propeller cap, or “spinner,” at the forward end of the cylinder using a hemisphere and AutoGrid.

Add the propeller spinner:

-  1 Zoom into the Perspective viewport so you have a close view of the front end of the cylinder. Click the viewport label, and set the shading mode to Smooth + Highlights and Edged Faces.

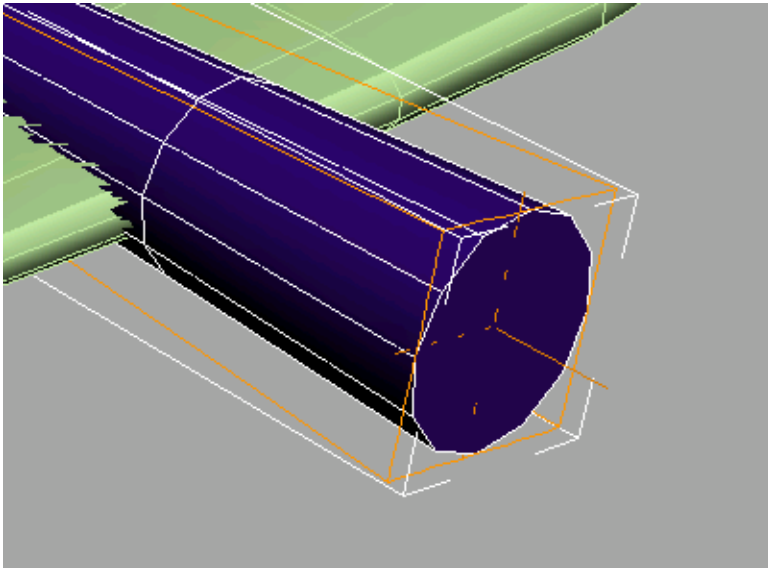

-  2 Open the Create panel. In the Object Type rollout, click to turn on Sphere.
- 3 Turn on AutoGrid, the check box below Object Type. Now move your cursor over the surface of the end of the cylinder.

An axis tripod follows your cursor, showing you where the sphere will be drawn.

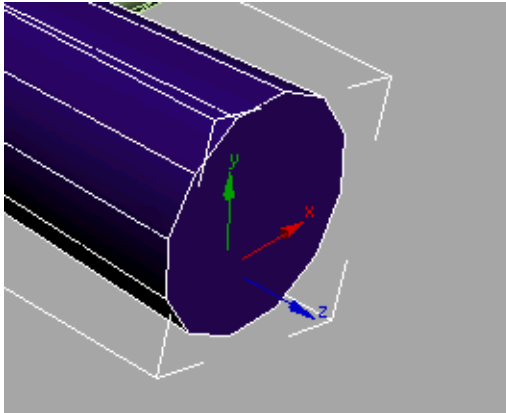

- 4 In the Parameters rollout, turn on Base To Pivot.
This lets you draw a sphere off the end of the cylinder.
- 5 Move your cursor over the end of the cylinder, and draw a sphere.
It doesn't matter what size; you will adjust the parameters after you draw it.
- 6 Edit the Parameters, as follows:
 - Radius=**0.558m**
 - Segments=**12**
 - Hemisphere=**0.5**
Now instead of a sphere, there is a hemisphere.



- 7 Rotate the hemisphere so the 12 segments of the cylinder and the hemisphere are at the same angle. Fifteen degrees about the Y axis.



- 8 On the main toolbar, click the Align button, then click the cylinder. In the Align Position (World) group, turn on X Position and Z Position. This properly aligns the hemisphere and the cylinder. Click OK

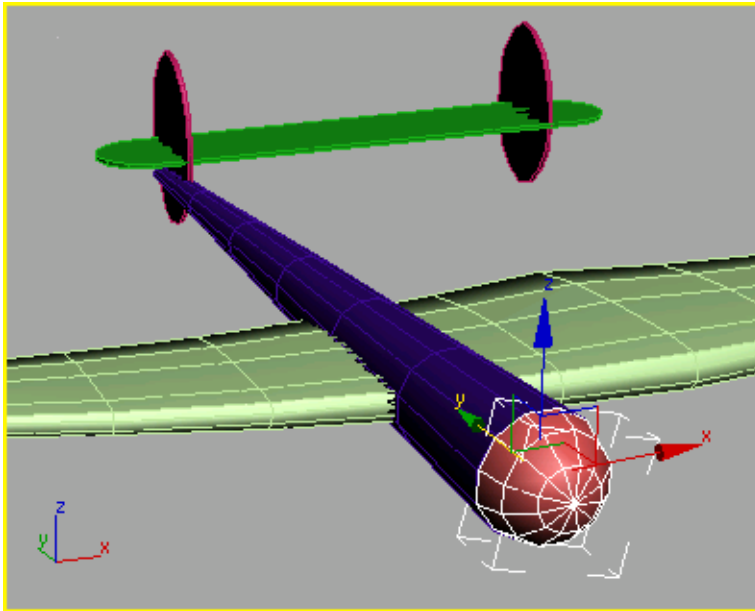

The spinner is aligned to the end of the sponson.

9 Rename this object **starboard spinner**.

10 Save your scene as **myp38_sponson.max**.

You'll be converting the sponson cylinder to an editable poly so it's a good time to save your scene.

Finish shaping the sponson:

1 Select the sponson cylinder object and right-click. Choose Convert To: > Convert To Editable Poly from the quad menu.

2  In the Selection rollout, click Vertex.

3  In the Left viewport, select a column of vertices and then on the main toolbar, choose Non-Uniform Scale from the scale flyout. Non-uniform scale them closer together, watching the bitmap as a guide. Then right-click, choose Move from the quad menu, and position the row.

- 4 Repeat this process for all seven columns of vertices in the Left viewport, so the outline of the sponson matches the background more closely.

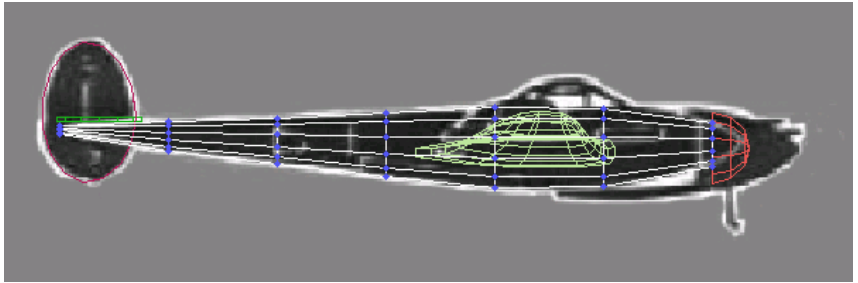

Select one column at a time, scale, then move.

- 5  Click the Vertex selection button to turn it off, then select the spinner hemisphere in the viewport.
- 6 Move the propeller spinner away so you can see the end of the sponson in the Perspective viewport.

- 7  Select the cylinder again and turn on Vertex selection.
- 8 Select the vertices in the forward end of the cylinder and non-uniform scale them about the X axis only. Use the Transform gizmo X arrowhead, and watch the coordinate display in the status bar. Scale down to **60** percent along the X axis.

This returns the end of the cylinder to a more circular shape.

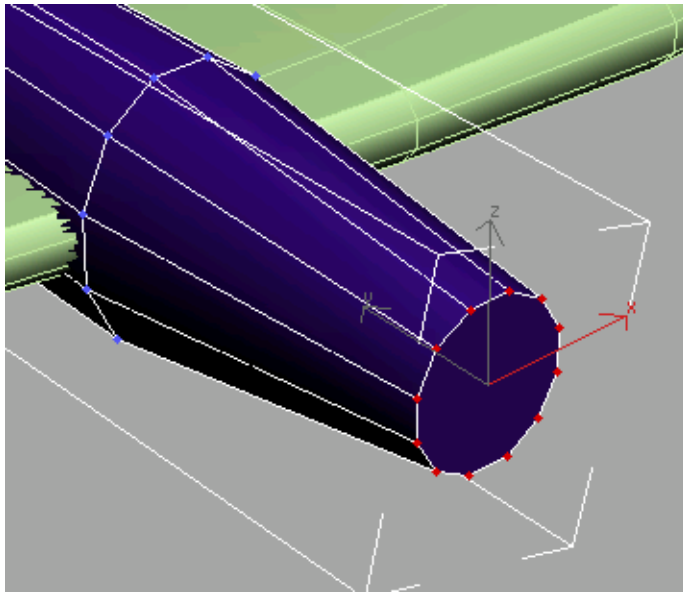

- 9 Turn off sub-object selection by clicking Vertex again in the Selection rollout, then move the hemisphere back into place. Change its radius so it fits over the end of the sponson again.

Finish the propeller spinner:

- 1 Collapse the hemisphere to an editable poly by right-clicking, and choosing Convert to: Convert to Editable Poly.
- 2 In the Perspective viewport, select the vertex in the center of the hemisphere.
- 3 In the Soft Selection rollout, turn on Use Soft Selection and adjust the Falloff so the second ring of vertices turns yellow, but the last rows do not. Move the selection forward along the Y axis.

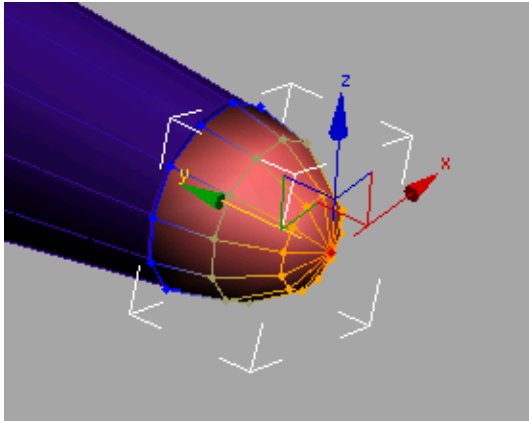

- 4 Lower the soft selection so only the vertex at the tip is selected, and move the tip forward to form the bullet shape.

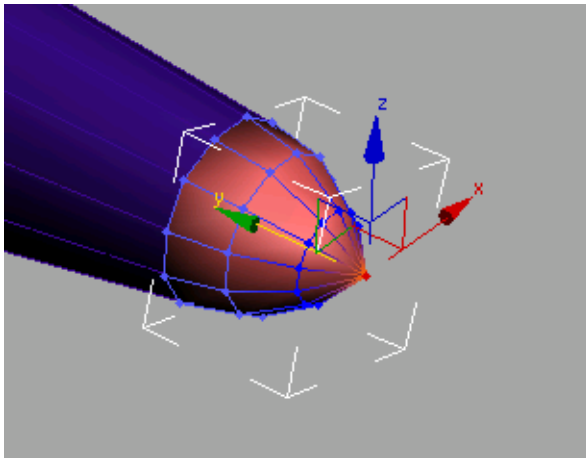

- 5  Click the Vertex selection button to turn it off.
The sponson is almost finished. There is a blister on either side of the sponson that serves as the exhaust waste gate outlet. You'll create this next, using the Bevel features.
- 6 Save your scene as **myp38_sponson2.max**.

Create the exhaust gate outlet:

- 1 Select the sponson.



- 2 Turn on Vertex selection for the sponson.

- 3 In the Top viewport, select the third row of vertices from the top and move them down so they are at the end of the exhaust gate.

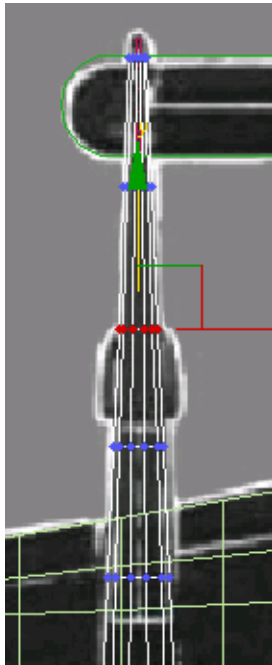

Select and move these red vertices down.

- 4 Select the fourth row and move them up, so they are positioned at the start of the exhaust gate.

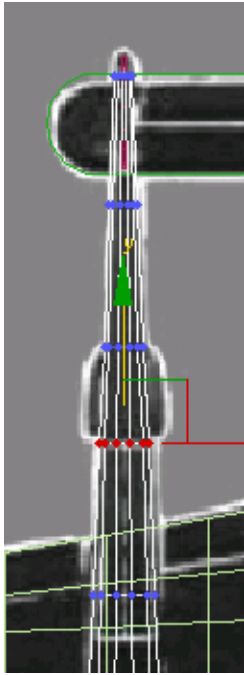

Select and move these red vertices up.

The vertices now line up in the top view, but need adjustment in the left view.

- 5 In the Left viewport, scale the selected vertices smaller along the Y axis, as necessary against the profile of the background image.



- 6 On the Selection rollout, choose Polygon.
This lets you select polygons instead of vertices.



- 7 Make sure the Select Object button is turned on. In the Left viewport, drag a selection window over the polygons shown in the illustration below.

The selected polygon displays in red. If you don't see a fully shaded polygon, only surrounding edges, click the plus (+) sign next to the Left

viewport label and choose Configure. In the Rendering Options group, turn on Shade Selected Faces.

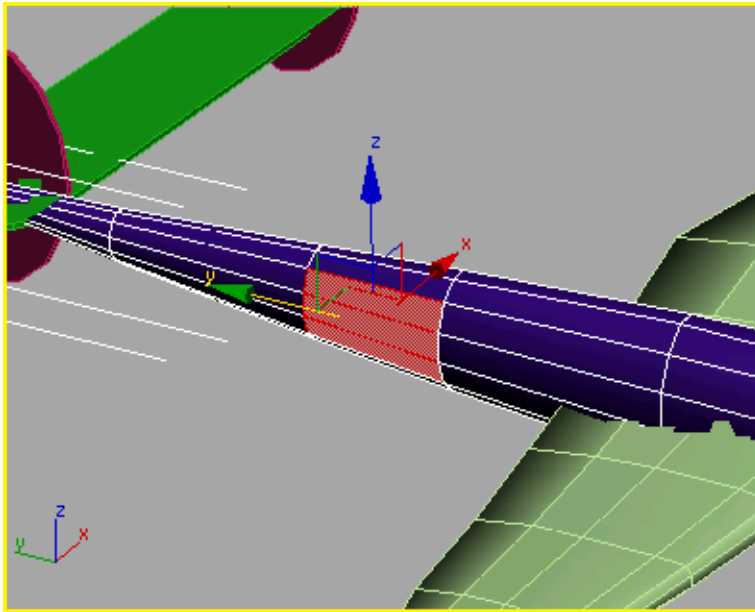

Dragging the selection window over these three polygons in the Left viewport also selects the three polygons on the opposite side of the sponson.

NOTE It's important to have Select Object active here. If Select And Move were active instead, after making the first corner of your selection window you'd start dragging the polygon around, giving you undesired results.

- 8  On the Edit Polygons rollout, click the Bevel Settings button to open the Bevel Polygons dialog.
- 9 Set the Height setting to **0.152m**. Set the Outline Amount to **-0.095m**. Click OK.

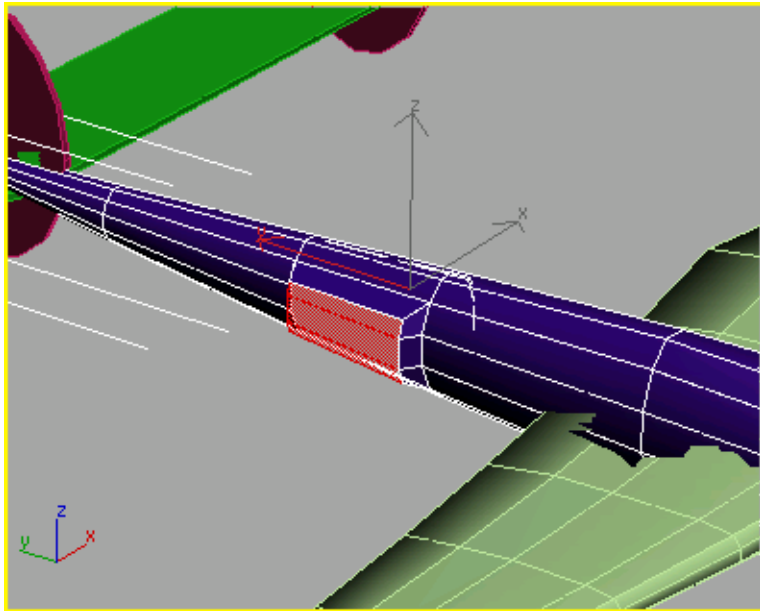

-  **10** Region Zoom around the exhaust gate in the Left viewport.
Because you have Lock Zoom/Pan turned on for the background image, you might see a dialog warning that some amount of memory is necessary to redisplay the background. Click Yes.
- 11** Once again, use a selection window to select the newly created polygons at the front of the exhaust gate, and then hold down the Ctrl key and drag another selection window across the polygons at the rear.
This will also select the polygons on the opposite side of the sponson.

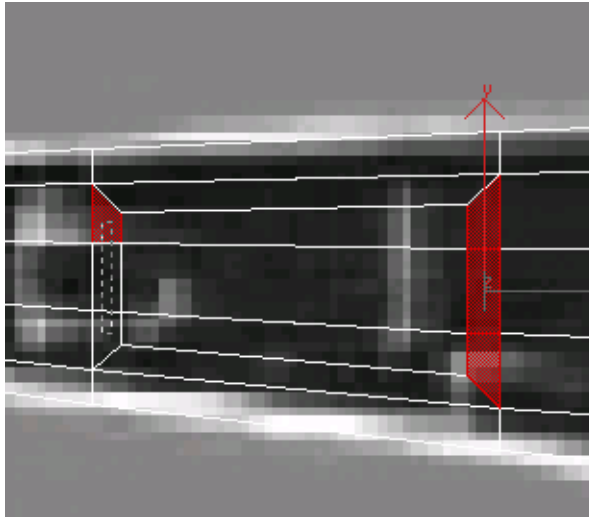

- 12  Click the Bevel Settings button and set the Height to **-0.1m** and the Outline Amount to **-0.025m**. Click OK.

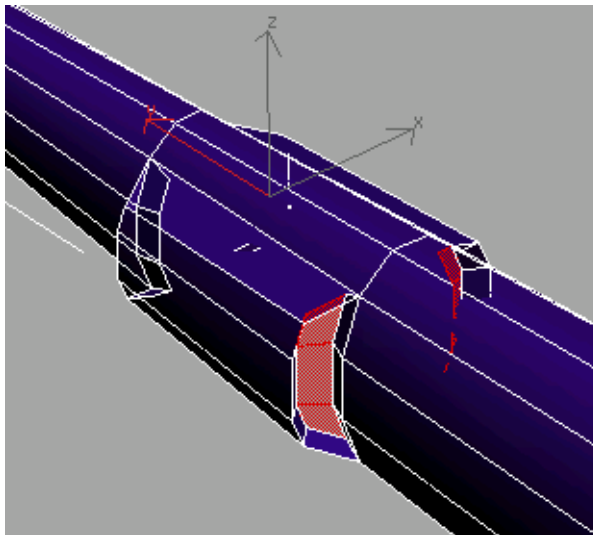

- 13 In the modifier stack, click Editable Poly to exit the sub-object level.
14 Save your scene as **myp38_sponson3.max**.

Next, you'll clone the starboard sponson and spinner to make the port sponson and spinner.

Clone the sponson:

- 1 Select the sponson, if it isn't selected already.
- 2 Hold down the Ctrl key and click the propeller spinner.
Now both objects are selected.



- 3 In the Top viewport, hold down the Shift key and move the selected objects to the right.
The Clone Options dialog appears.
- 4 Name the clone **port sponson** and click OK.
- 5 Select the new propeller spinner on the port side and rename it to **port spinner**.

TIP Feel free to change the colors of all the objects so the plane looks more realistic.

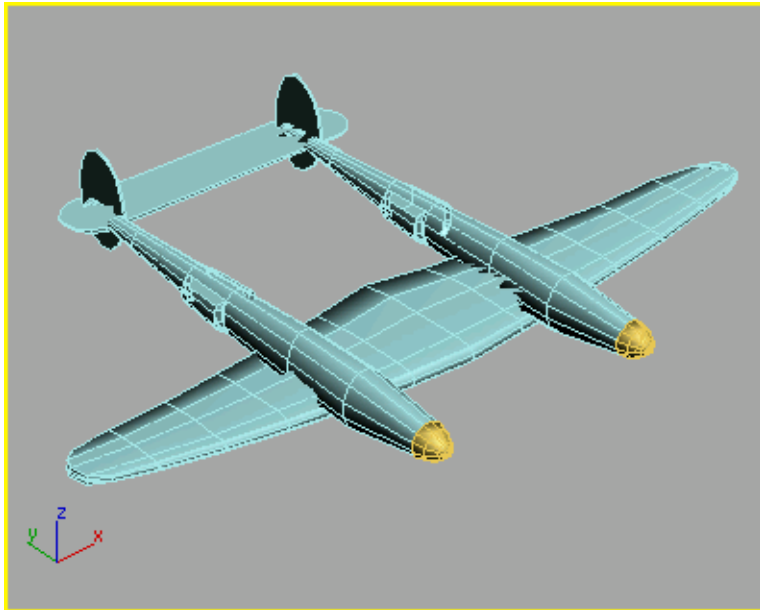

The P-38's wing, sponsons, and tail

- 6 Save your work as **myp38_nogondola.max**.

All that remains is the central gondola and canopy detail.

Creating the Gondola

The plane is starting to look like a P-38, but it's missing the central gondola, the pilot cockpit. You will create the gondola using the same techniques you learned when you shaped the sponson. To ensure that the gondola is symmetrical, you'll use the Symmetry modifier.

Load a start file:

- Continue from the previous lesson, [Creating the Sponsons](#) on page 163, or load *p38_build_gondola.max* found in the `\modeling\p38_lightning` folder.

Create the gondola:



- 1 Go to the Create panel, and on the Object Type rollout, click to turn on Cylinder.

If you're continuing from the previous lesson, make sure AutoGrid is turned off.

- 2 In the Front viewport, drag out a cylinder over the gondola, until the radius approximately matches the height of the gondola in the background image.

Watch in the Top viewport as you drag the height of the cylinder, since the Front viewport will not show any difference.

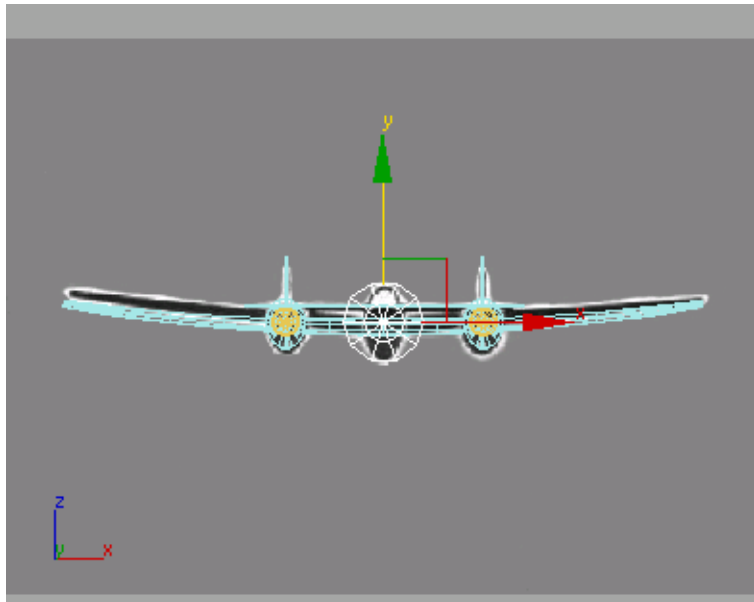

3 Edit the cylinder's parameters, as follows:

- Height Segments=9
- Cap Segments=2
- Sides=10

4 In the Name And Color rollout, name the object **gondola**.



5 If necessary, move the gondola object in the Top viewport so the top lines up with the trailing edge of the wing.

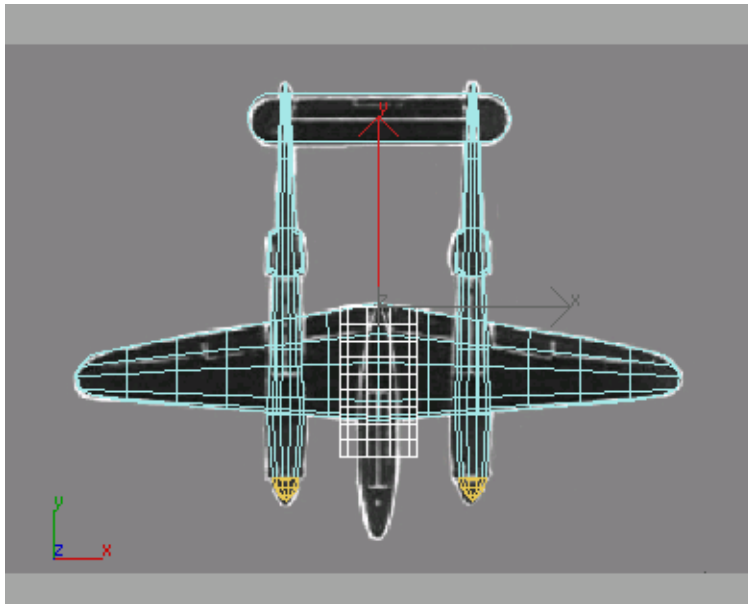

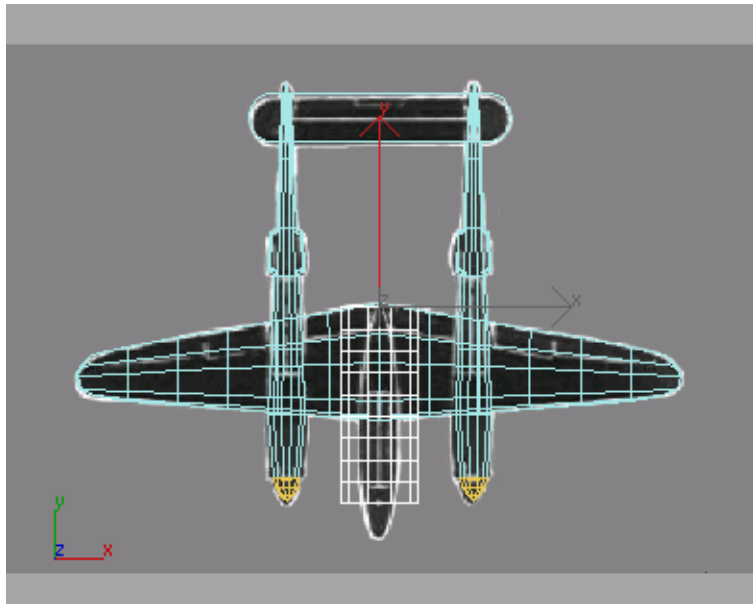

Line up the cylinder with the trailing edge of the wing.

-  On the Modify panel, adjust the height of the cylinder so it is even with the end of the sponsors, as illustrated below.



Start with a cylinder.

Shape the gondola:

-  1 Go to the Display panel, and hide everything but the gondola by clicking Hide Unselected in the Hide rollout.
-  2 Go to the Modify panel. In the modifier stack, right-click Cylinder and choose Convert To: Editable Poly.
Now you can reposition the vertices over the background images.
-  3 On the Selection rollout, click Vertex.

- 4 Starting at the rear of the gondola, in the Left viewport and do the following:
- Select the leftmost column of vertices.
 - On the main toolbar, choose Non-Uniform Scale from the Scale flyout.
 - Scale them to the approximate size to match the background image.
 - Move them down to match the background image as well. Alternate between scaling and moving as you work your way forward.

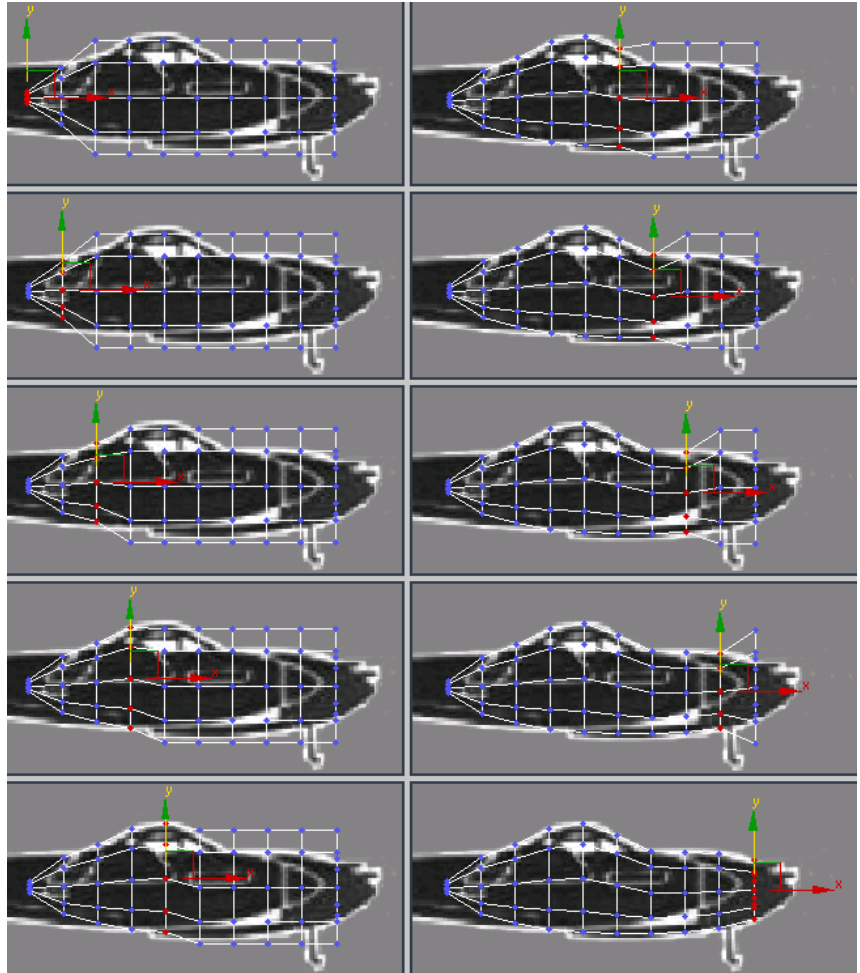

Scale and move the vertices to match the background.

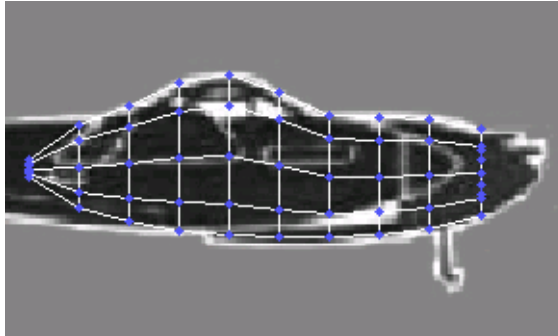

Placement of vertices from Left viewport.

- 5 With all that work done, save your scene as **myp38_gondola.max**.
- 6 Activate the Top viewport and repeat the previous process. Select one row of vertices at a time and position them over the background image using Scale and Move tools. Using the Transform gizmo, scale each row only along the X axis.

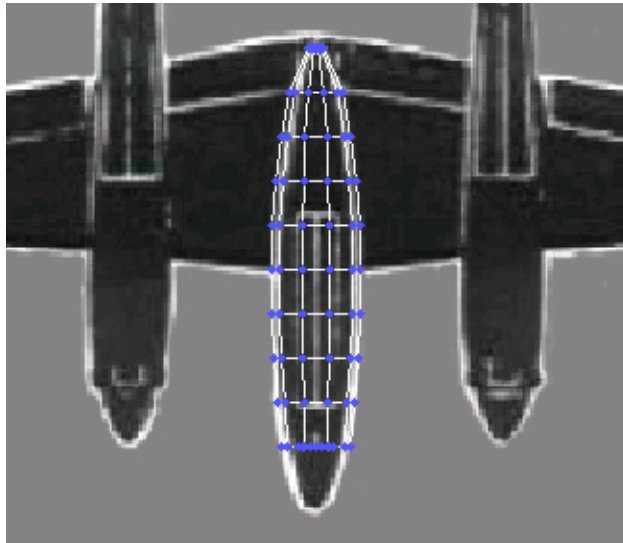

Vertex scaling and placement from the Top viewport.

- 7 In preparation of building the canopy, move and scale columns of vertices to match the outline of the cockpit in the Left viewport.

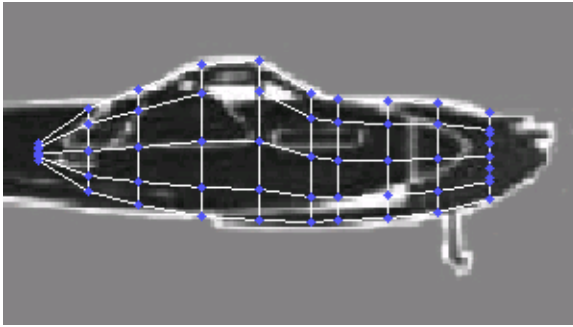

The 4th, 5th and 6th columns of vertices are moved and scaled.

- 8 Activate the Perspective viewport and start creating the nose by selecting the single vertex at the center of the cylinder cap. Then turn on Soft Selection and adjust the Falloff so the next ring of vertices turns yellow.

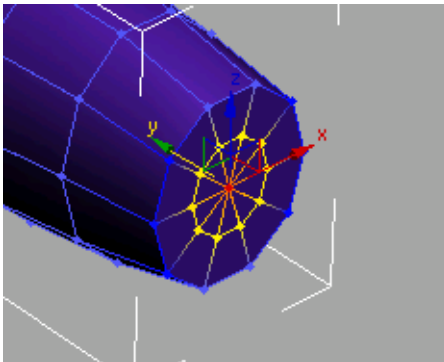

- 9 While watching the Left and Top viewports, move the soft selection forward to form the nose. Turn off Soft Selection, and move the single end vertex to create the point.

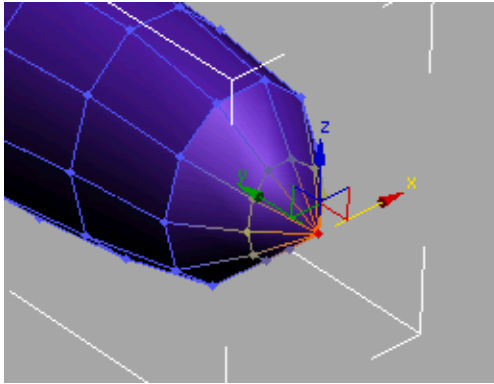

- 10** The nose might be a little too pointy, so from the Left and Top viewports, scale and move the second column of vertices to round the nose.

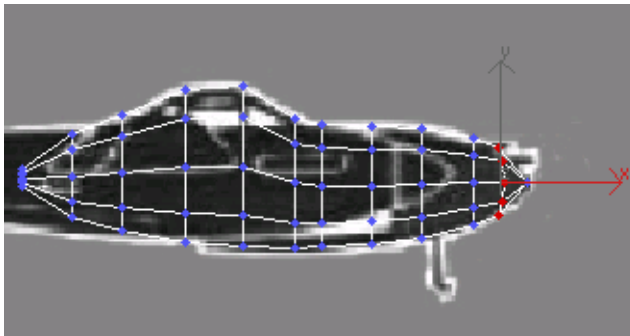

- 11**  To unhide the rest of the airplane, on the Display panel, choose Unhide By Name. Select all the components you have created (everything except the calibration box).
- 12** Change the color of the gondola to match the rest of the plane.
- 13** Make adjustments as needed. Select the row of vertices at the rear of the gondola and move them along the Z axis in the Perspective viewport, so the rear taper is hidden in the wing.
You might also have to select the gondola and wing and move them up.

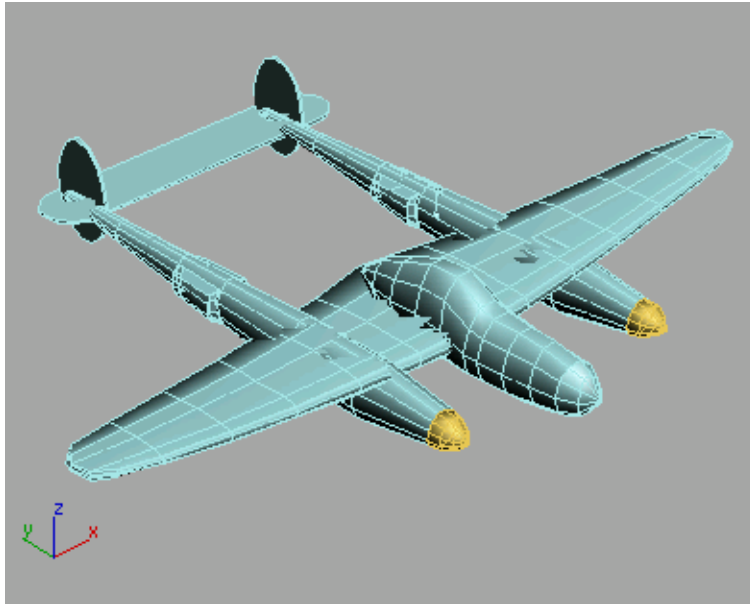

P-38 with gondola

- 14 Save your scene as **myp38_gondola2.max**.

You can create the canopy using a couple of editable poly tools. You'll cut and chamfer to create this detail of the cockpit.

Add the canopy:

- 1 In the Perspective viewport, select the gondola, if it's not already selected, and zoom in so you can see a close view of the cockpit area.



- 2 On the Selection rollout, click Edge, then turn on Ignore Backfacing.
- 3 On the Edit Geometry rollout, turn on Cut.
- 4 Cut new edges into the cockpit. Click to set the beginning of an edge, then move the mouse to draw the new edge. Click again to set the end of the edge.

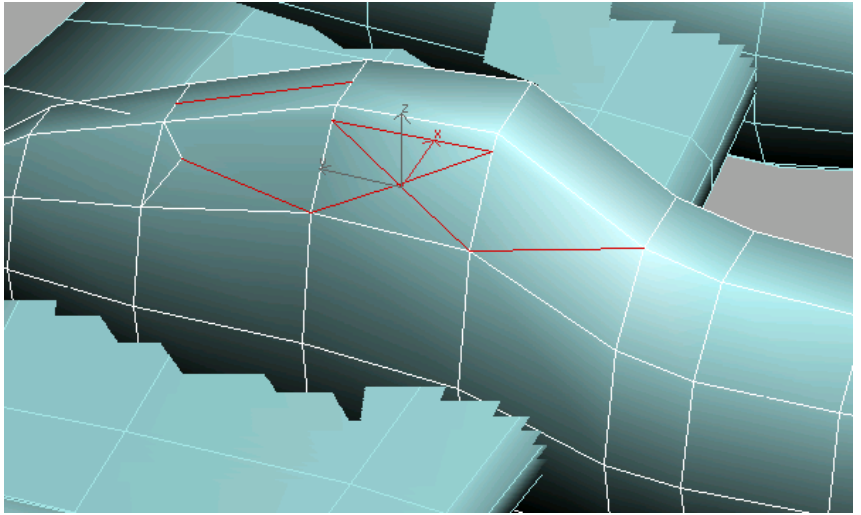

Cut these new red edges to form one side of the cockpit.

- 5  Orbit the view and make the same cuts on the other side of the cockpit.

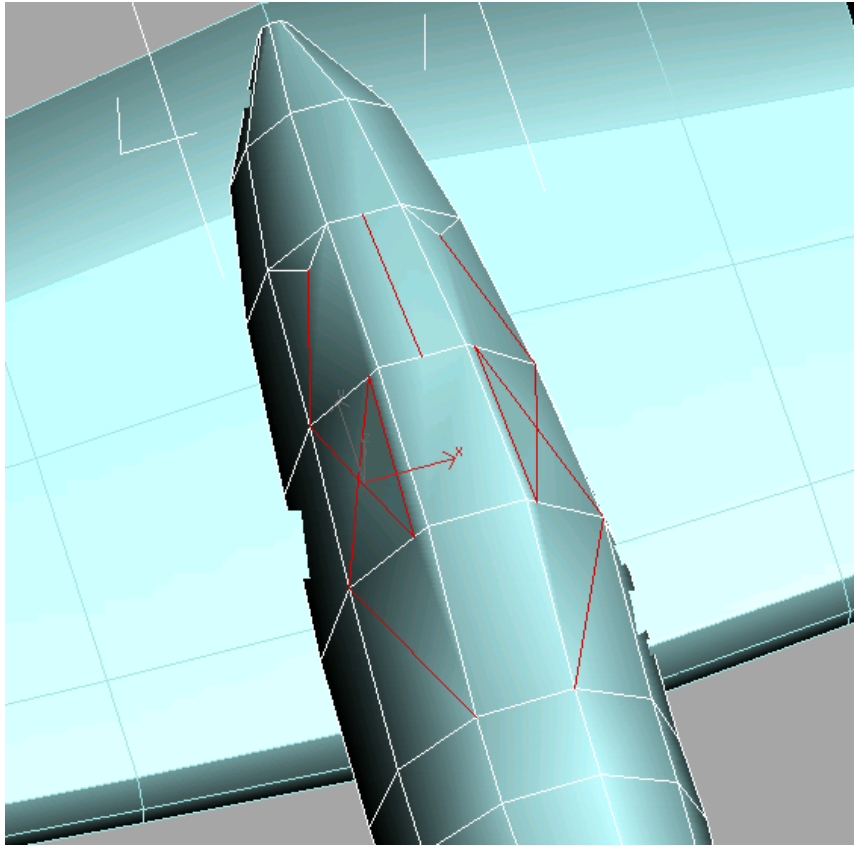

All these edges should be cut.

- 6 Click Cut again, to turn it off.
Now, you can chamfer edges to create the metal frame of the canopy.
- 7 In the Selection rollout, turn on Ignore Backfacing and select the edges around the cockpit, as illustrated below.

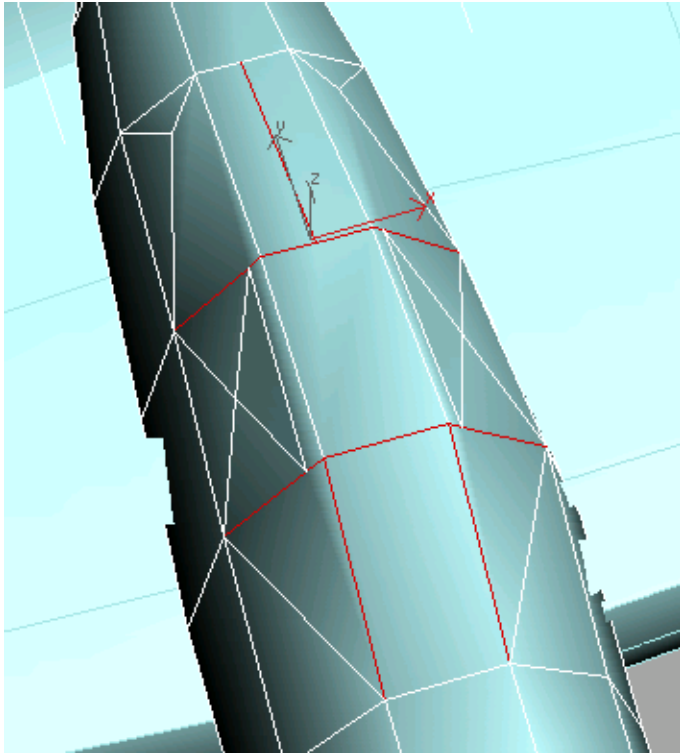

Select these red edges.

- 8 In the Edit Edges rollout, turn on Chamfer. Move your cursor over one of the selected edges, click and drag up until it looks like the illustration below, and then release the mouse button.

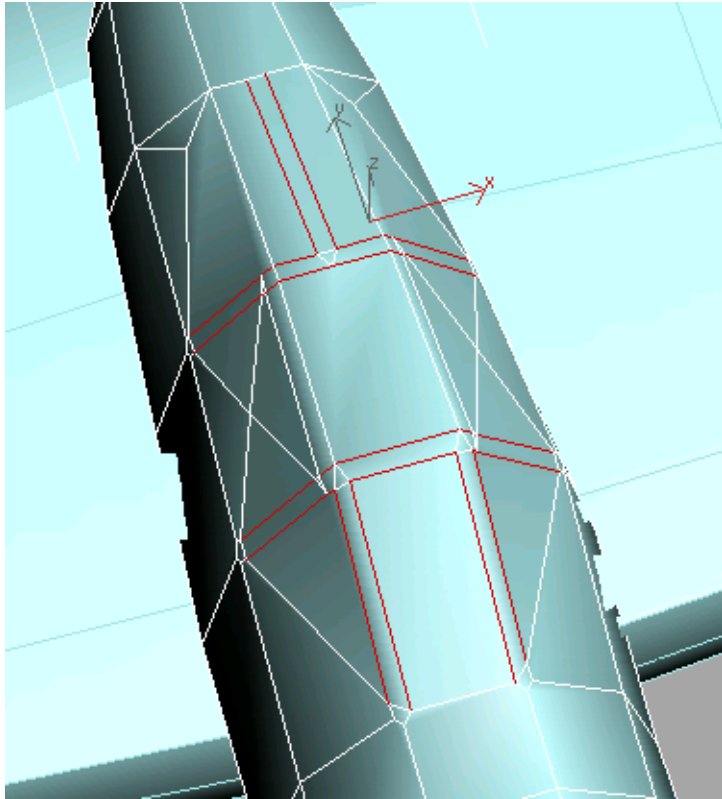

Chamfer edges to create the metal canopy frame.

- 9 You can apply a transparent material to the canopy faces for extra detail. To apply a material to selected polygons in the model, you would use a Multi/Sub-Object material.

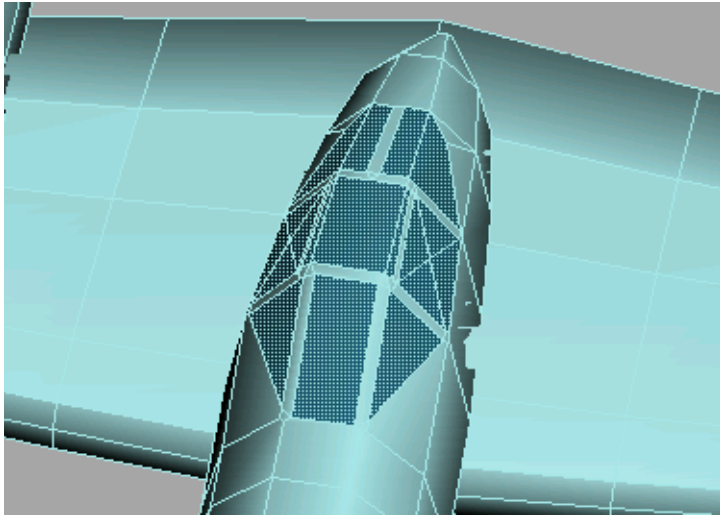

P-38 gondola with completed canopy.

10 Save your work as **myp38.max**.

Make sure the gondola is symmetrical:

The Symmetry modifier was added to 3ds Max specifically for the purpose of building symmetrical models such as airplanes, boats, and characters.

In the previous section, you cut a lot of edges to make up the canopy frame and glass. Some of those new edges may not be the same on either side of the gondola. Using the Symmetry modifier will ensure that the gondola is symmetrical.

You can continue from the previous procedure or open *p38_lightning.max*.

- 1** Select the gondola object.
- 2** In the Perspective viewport, right-click the gondola to open the quad menu and choose Isolate Selection.



- 3** Open the Modify panel and turn on Element mode and select the gondola.

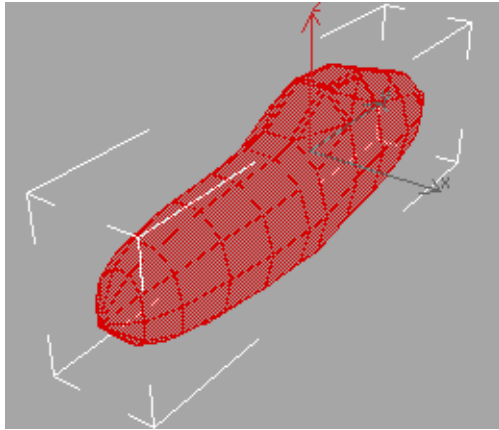

The selected element in red.

- 4 From the Edit Geometry rollout, click Slice Plane.
The gizmo appears, but it's not in the right orientation.



- 5 Click the Select And Rotate button from the main toolbar and enter **90** in the Z coordinate field below the time bar.

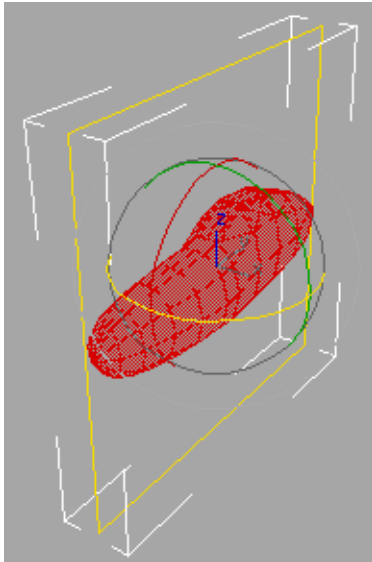



The slice gizmo is rotated correctly.

- 6  If necessary, move the gizmo left or right so it's centered on the gondola.

TIP Zoom in the Top viewport to better adjust the gizmo position.

- 7 When the gizmo is positioned correctly, click the Slice button. Turn off Slice Plane.

- 8  Turn on Polygon mode and in the Top viewport drag a selection window around the right side of the gondola.

TIP  In the Selection rollout, make sure Ignore Backfacing is turned off and maximize the Top viewport when dragging the selection window.

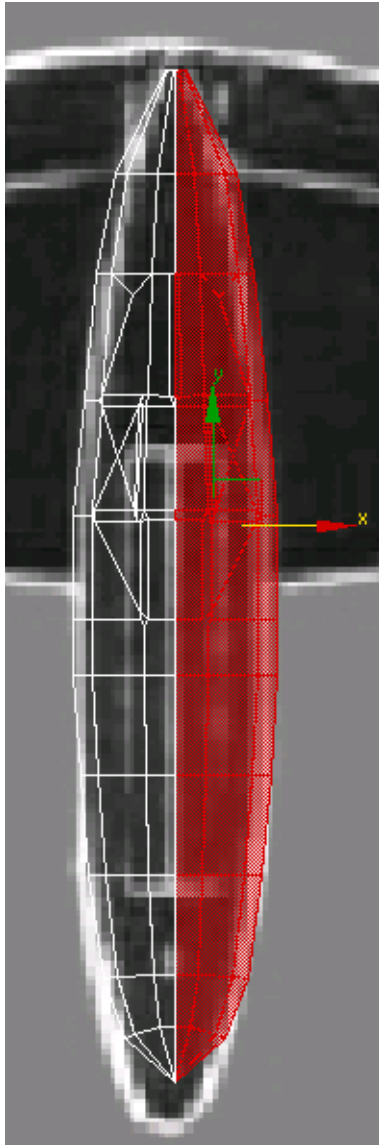

Half the gondola is selected.

- 9 Press the Delete key and, if asked if you want to delete isolated vertices, click Yes.

NOTE You might have to zoom in on the rear end of the gondola to select some very small polygons and delete them as well.

- 10  Turn off Polygon mode and choose Symmetry from the Modifier List.
The Mirror gizmo appears at the gondola's pivot point.
- 11 In the Parameters rollout out, turn off Slice Along Mirror.
The new half is created and it is automatically welded.

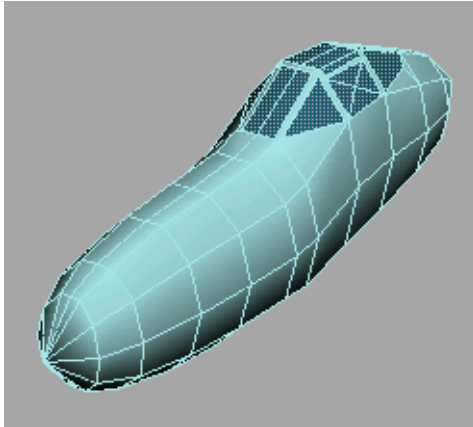

The whole gondola

- 12 Turn off Isolation Mode to view the rest of the model.
- 13 If you're working on your own P-38, there are many more details you could add, such as propellers, machine guns, and landing gear. Feel free to continue on your own. The *p38_lightning.max* has some detail added.

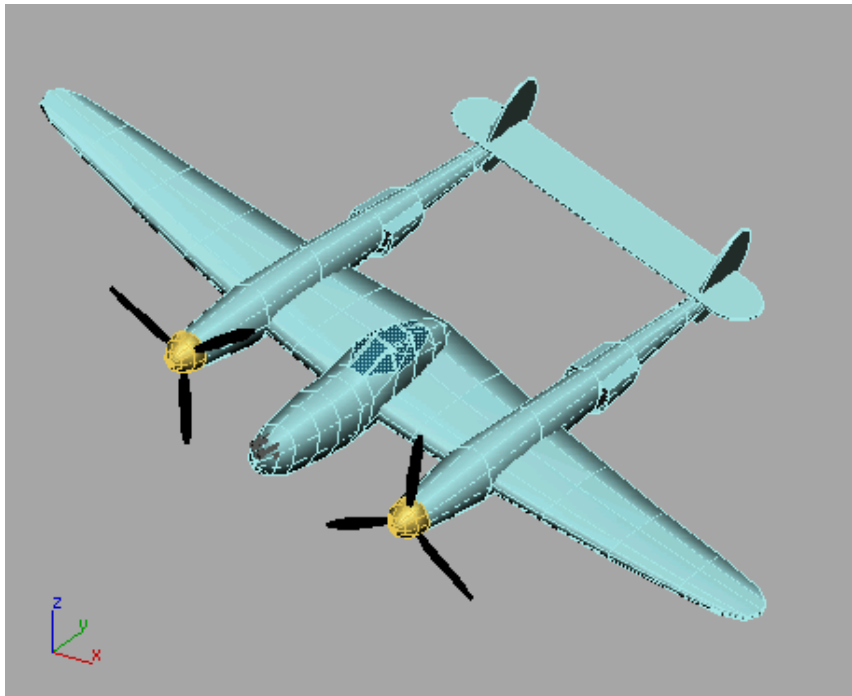

Propellers and machine guns added

Finishing the Plane

One major step remains: to link the plane into a single hierarchy. Before it's airworthy, however, you'll also need to rotate it into the proper orientation and adjust a pivot.

Load a start file

- Continue from the previous lesson, [Creating the Gondola](#) on page 180, or load *p38_lightning.max* found in the `\modeling\p38_lightning` folder.

To work properly with Microsoft Flight Simulator (FS), the pivot point of an aircraft used by FS as its center, should be midway between the propellers, and a quarter of the way back from the front of the wings. In this procedure, you'll make that adjustment in the Top viewport.

Adjust the gondola pivot

- 1 Activate the Top viewport and press Alt+W to maximize it.
- 2 Select the gondola object.

- 3  In the Command panel, click the Hierarchy tab. In the Adjust Pivot rollout, click Affect Pivot Only.

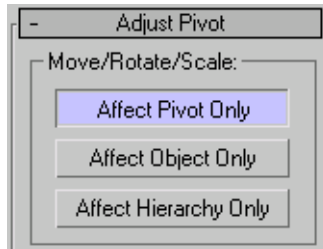

The gondola's pivot becomes visible, near its rear.

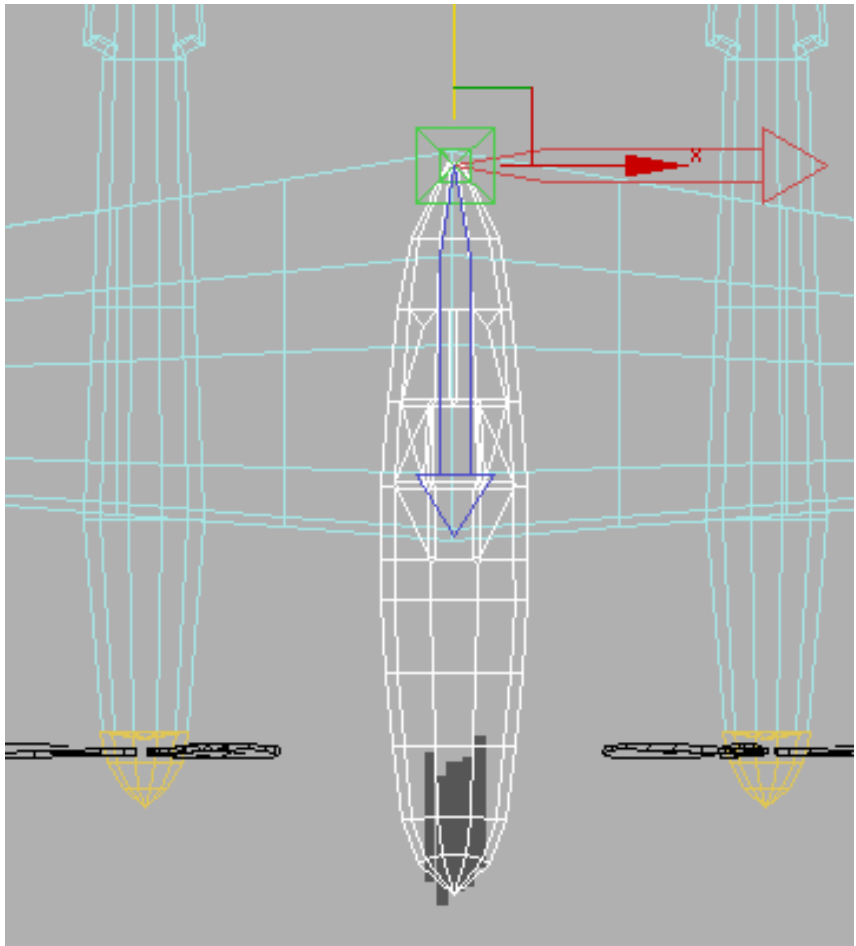

The gondola's pivot resembles the transform gizmo.

-  Use Select And Move to move the pivot downward along its Y axis so that the pivot is about a quarter of the way back from the front of the wings.

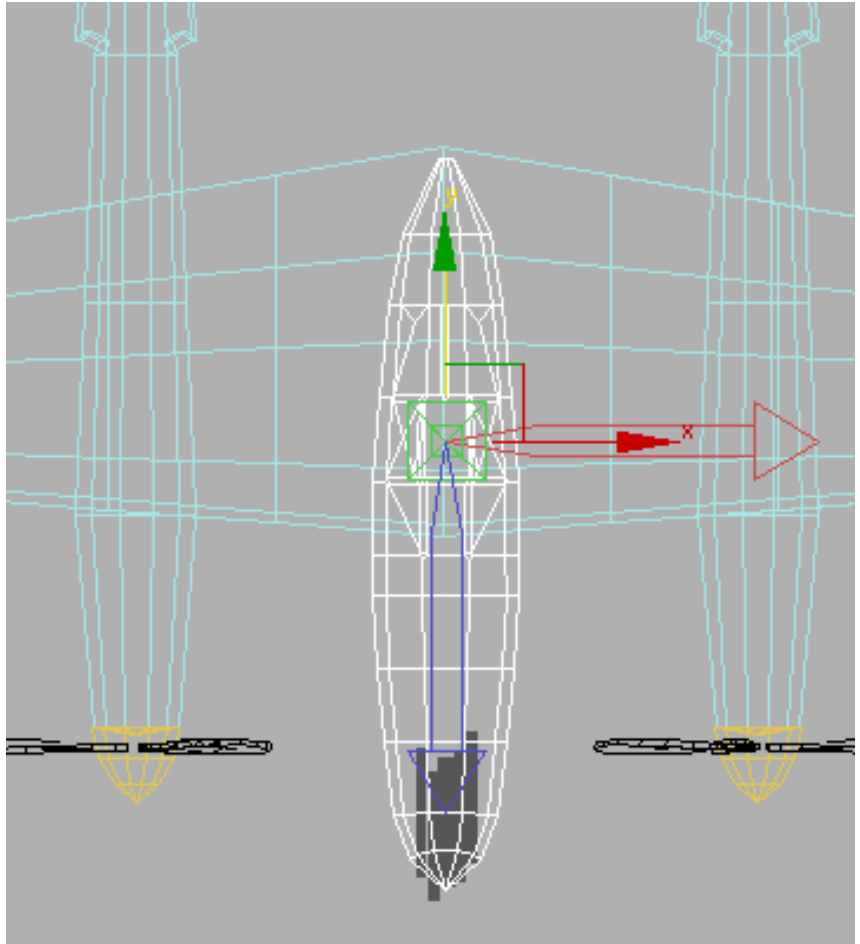

The gondola's pivot properly positioned.

- 5 In the Adjust Pivot rollout, click Affect Pivot Only again to turn it off.

Currently the plane looks like a single object, but it's really just a collection of unconnected parts. You can demonstrate this, if you like, by moving one of the parts, such as the gondola (if you do move it, be sure to undo before continuing). In this section, you'll connect all the parts into a hierarchy, so that moving the gondola moves the entire plane.

Build a hierarchy for the plane



- 1 Using the Select And Link tool, link the wing object to the gondola object. Click on the wing and drag the cursor over to the gondola, then release.
- 2 Next, link the two sponson objects to the wing object.
- 3 Continue linking until all objects belong to the same hierarchy, with the gondola as the topmost node. You can start in the Top viewport, but you'll probably need to use the others as you go along.

How you link objects is up to you; the only firm rule is that the gondola must be above all the other objects in the hierarchy. As a rough guide, link small objects to larger nearby objects. For example, you might link the propeller objects to their related spinners, and then the spinners to their sponsons. This would create a three-level hierarchy, with the sponson at the top, the spinner as its child, and the propeller blades as the spinner's children and the sponson's grandchildren.

As you work, keep switching to Select And Move and move the gondola to see which objects come along with it. When you're finished, no objects should be left behind when you move the gondola.



You can also check the hierarchy by clicking the Select By Name button on the main toolbar (or press the H key). On the Display Menu, make sure Display Children is on (with a check mark next to it), and then choose Display > Expand All. This displays the hierarchy as an indented list, with the parent object at the top.

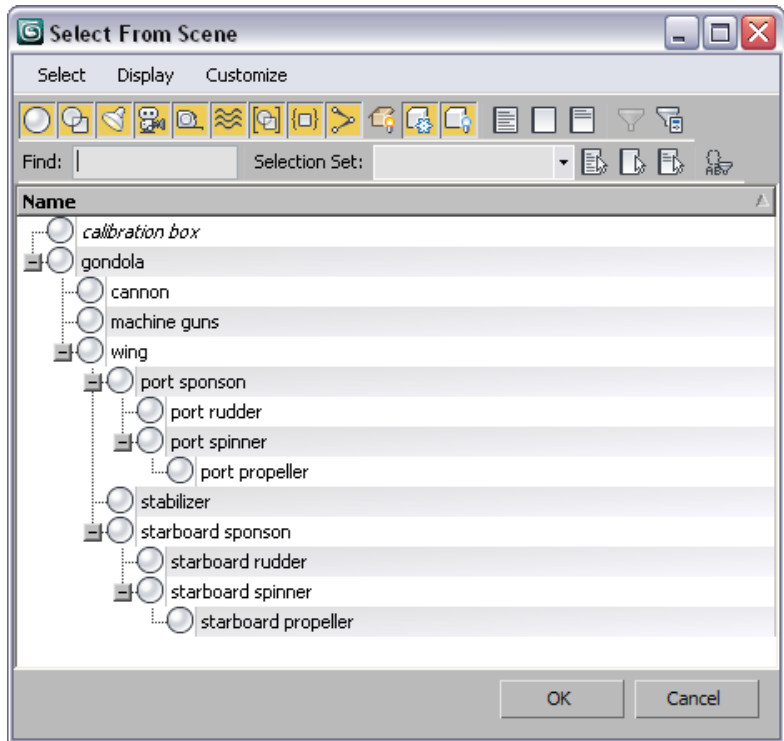

The final step is to rotate the plane so that it's pointing upward in the Top viewport. Otherwise you'll start out flying backward.

Turn the plane around

- 1 In the Top viewport, select the gondola.



- 2 On the main toolbar, click the Select And Rotate button.

- 3 On the status bar at the bottom of the screen, in the Coordinate Display area, enter **180** in the Z field.

When you press Enter, the displayed value changes to -180.0 , which is the same thing, rotation-wise.

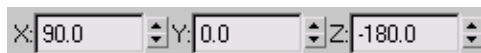

Also, the plane reverses its orientation in the Top viewport, facing upward.

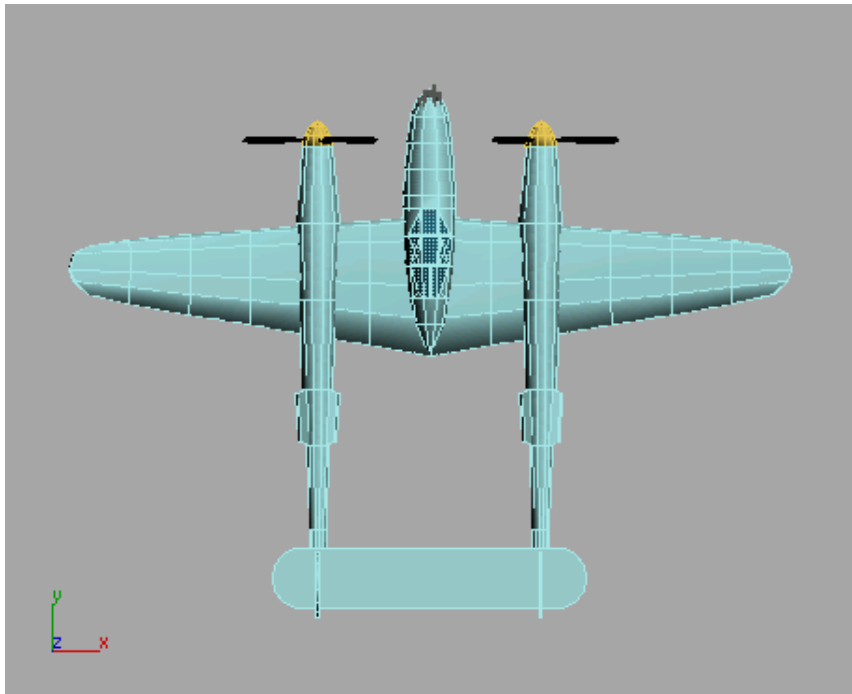

- 4 Save your work as **myp38.max**. Or you can open the completed file *p38_lightning_final.max*.

Summary

In this tutorial, you learned more about low-poly modeling using primitive objects like boxes, spheres and cylinders. You also made use of a background image to help in the modeling process.

Refining the Airplane

3ds Max has modeling features that can help you build models more efficiently. These lessons describe each feature and show you practical ways you can use them when constructing models.

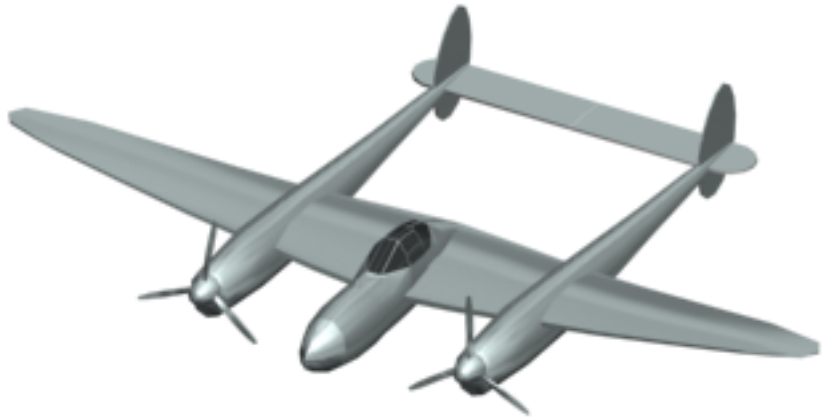

In this tutorial, you will learn how to:

- Weld vertices with the Vertex Weld modifier.
- Add detail to your model using Editable Poly tools.
- Select scene elements using soft selection.
- Use the HSDS modifier.
- Use the Edit Normal modifier.

Skill level: Beginner to Intermediate

Time to complete: 2 hours (15 to 20 minutes per lesson)

Using the Vertex Weld Modifier

In this lesson, you'll work on a model that was built with an older version of 3ds Max. It's a low-poly model of an airplane that was created using the Mirror tool.

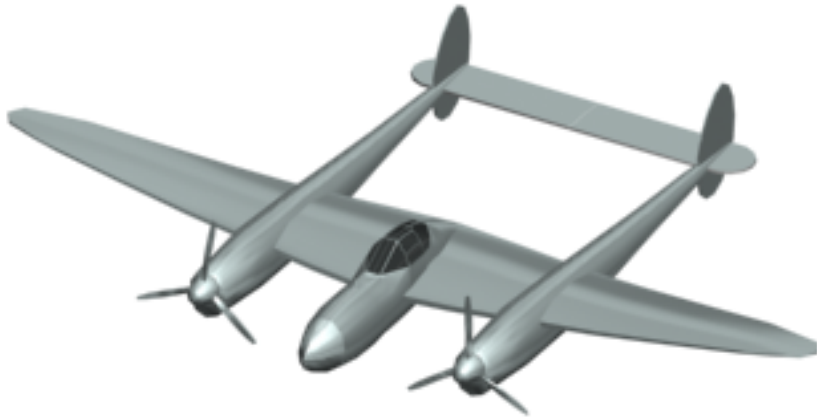

Low-poly airplane

Set up the lesson:

-  On the Quick Access toolbar, click the Open File button, navigate to the the `\modeling\p38_lightning` folder, then open the `low_poly_p38.max` file. This scene includes an airplane named *Lightning*.

Weld the seam between the two halves:

This model was built in an earlier version of 3ds Max using the Mirror tool, so there is a seam of unwelded vertices where the two halves of the plane meet.

- 1 In the Front viewport, select the airplane, *Lightning*.
- 2  Use Region Zoom to center the view on the cockpit section of the airplane.

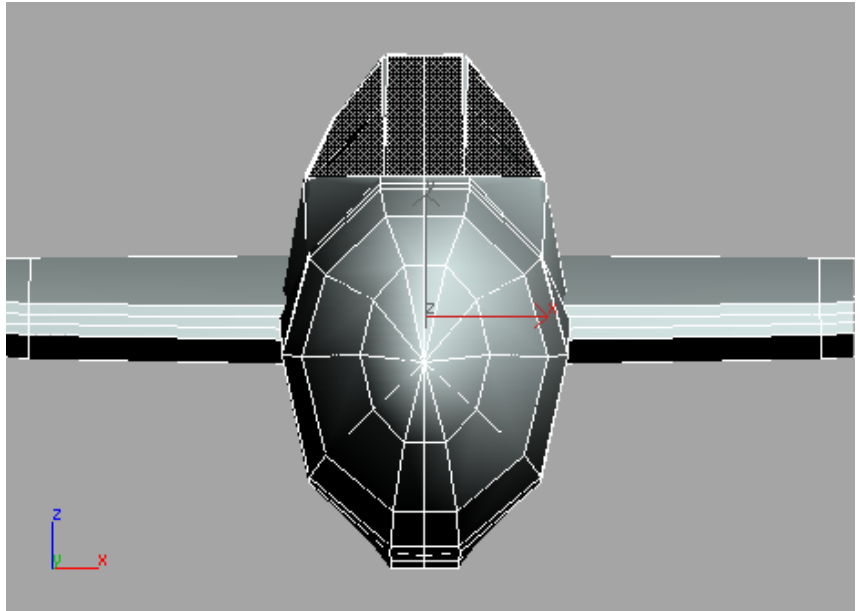

- 3 Choose Modifiers menu > Mesh Editing > Vertex Weld.



You can also apply the Vertex Weld modifier from the Modify panel > Modifier list > Object-Space Modifiers > Vertex Weld.

- 4 In the Parameters rollout, set the Threshold value to **.75"**.

This is one way to clean up the model.

NOTE Be careful not to set Threshold too high. If you do, the model will begin to degrade as more vertices get welded together.

- 5 Experiment a little by setting the Threshold to **1'**, then **6"**, and then **3"**. While the Vertex Weld can be used to reduce the number of faces a model has, greater values distort the model drastically.
- 6 Set the Threshold back to **.75"** and save the scene as **welded_lightning.max**.

Using the Editable Poly Tools

3ds Max has a set of handy editable poly tools that improve the way you can clean up and add detail to your models.

This set of lessons focuses on several tools.

Set up the lesson:

- Open *low_poly_p38_02.max* from the *\modeling\p38_lightning* folder.

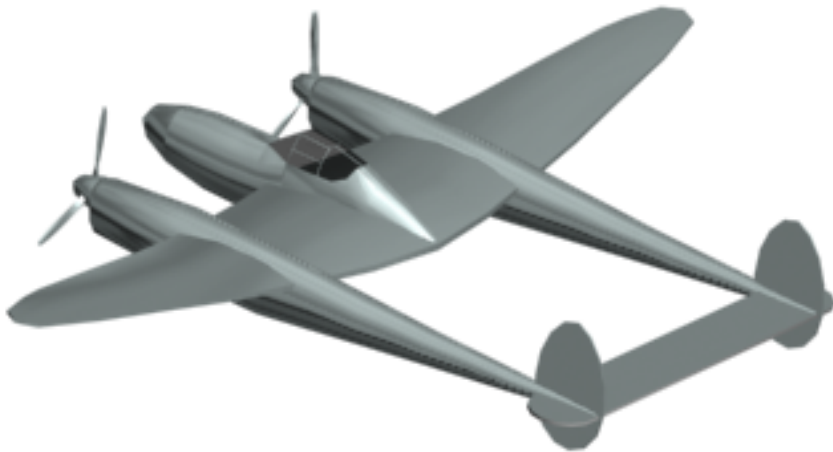

Detail the air intakes:

The first detail you'll add are the air intakes on the *sponsons* of your Lightning. The sponson is the long extension between the wings and the tail section of the airplane.

- 1  In the Right viewport, Zoom Region around the sponson between the wing and tail.

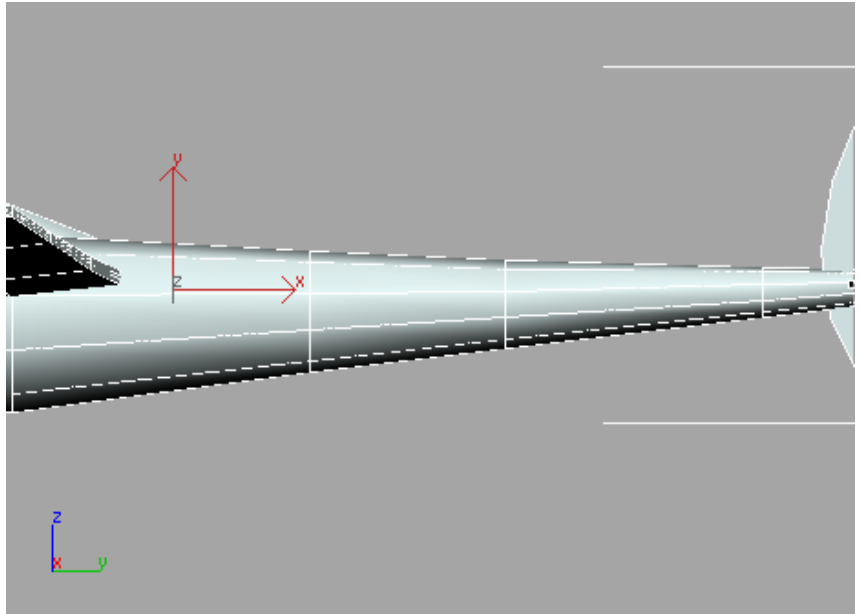

- 2 Select the object, *Lightning*.



- 3 Go to the Modify panel and click the Editable Poly entry in the modifier stack.

NOTE Half of the airplane disappears because you're working at a lower level in the modifier stack.



- 4 Click the Show End Result On/Off Toggle button that is located along the bottom of the modifier stack.

Turning on this toggle lets you see the results of additional modifiers all way up the modifier stack. You now see the other half of the airplane generated by the Symmetry modifier that was used in the sample file you opened for this lesson.



- 5 On the Selection rollout, click the Polygon button and make sure Ignore Backfacing is off.



- 6 Activate the Select Object tool and drag a window across the three polygons in the center of the sponson. Make sure the polygons at the top and bottom are not selected.

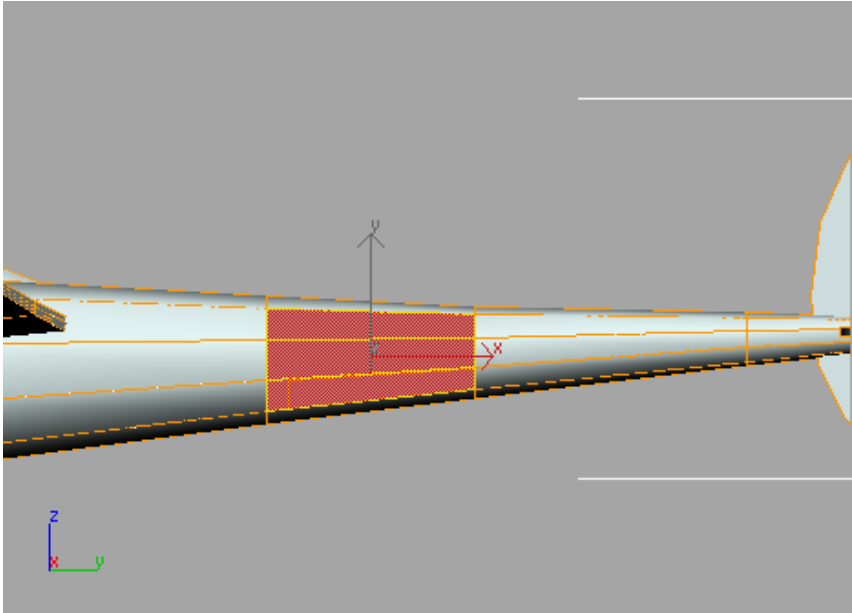

Because Ignore Backfacing is off, you've also selected the same three polygons on the other side of the sponson, for a total of six.

TIP To see the selected polygons displayed in red, press F2.



- 7 On the Edit Polygons rollout, click the Settings button next to the Bevel tool.

The Bevel Polygons dialog appears.

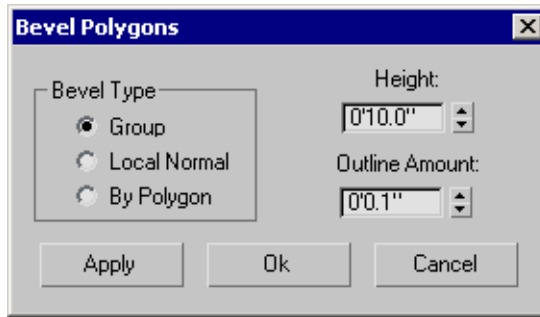

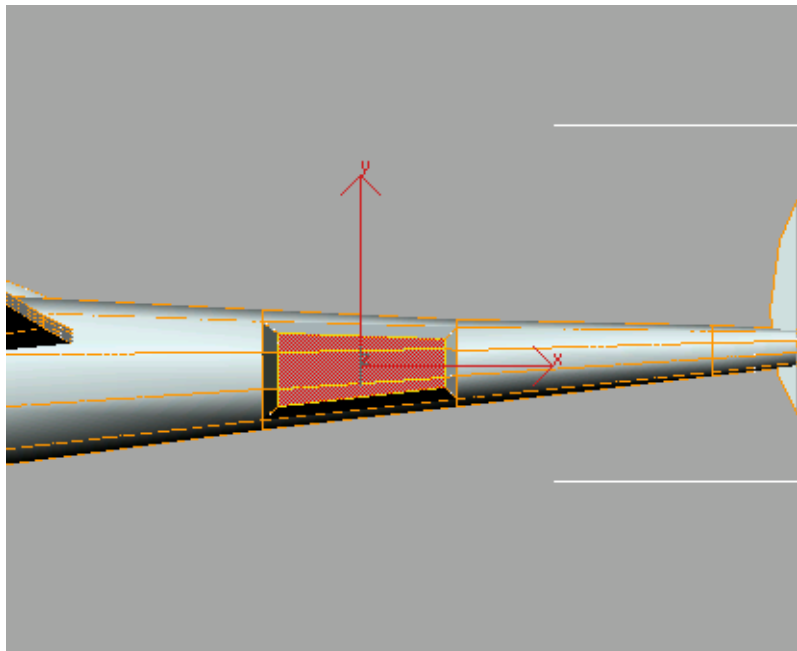

- 8 Set the Height to 7" and the Outline Amount to -3.5". Click OK.

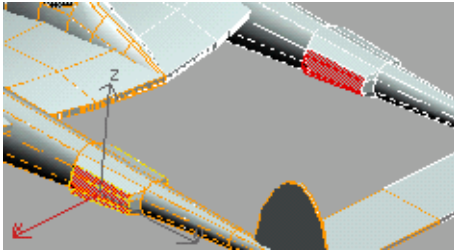

The air intake starts to take form.

Using the Symmetry modifier ensures that changes you make to the original half of the airplane are automatically reflected in the mirrored half.



- 9  Make sure Select Object is still active, and then click the Grow button on the Selection rollout. Grow increases the polygon selection to include polygons that share a common edge.

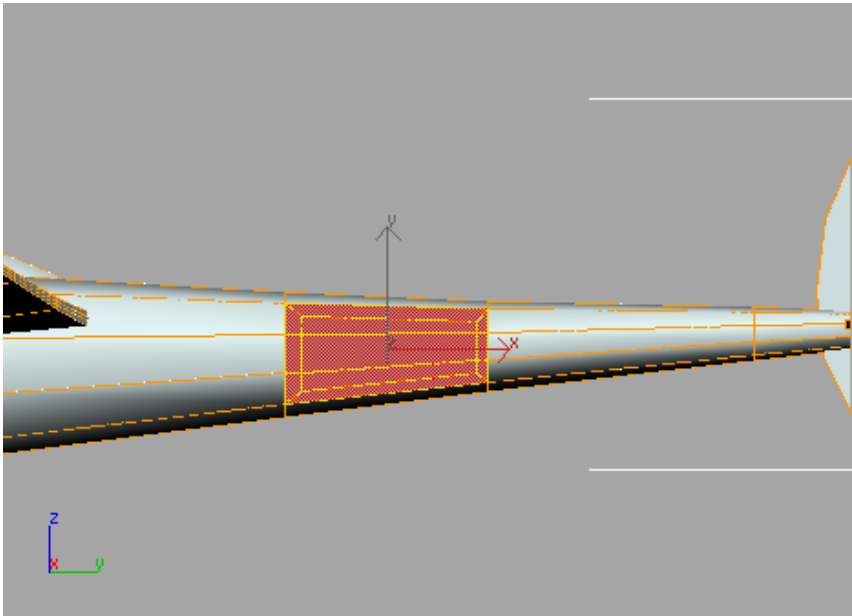

- 10 While holding down the Alt key, drag a window across the middle set of polygons to deselect them. Select only the polygons on the left and right, as viewed in the Right viewport.

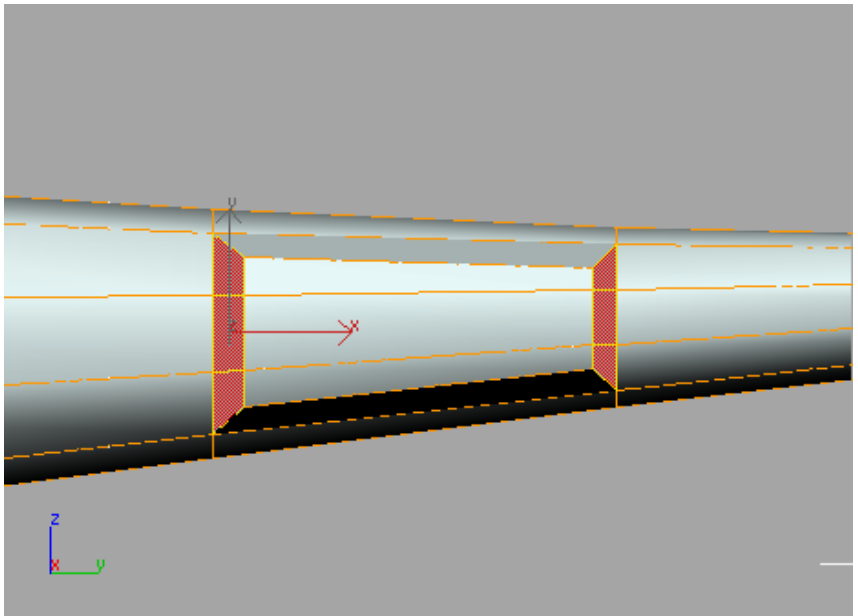

- 11  Click the Settings button next to the Inset tool in the Edit Polygons rollout.
The Inset Polygons dialog appears.

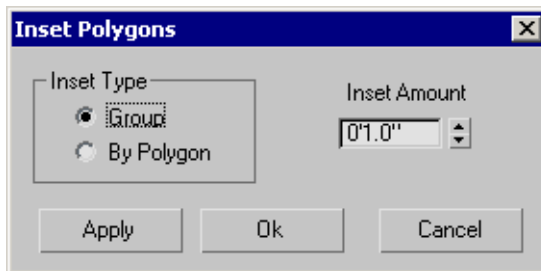

- 12 Set the Inset Amount to 1.5" and click OK.

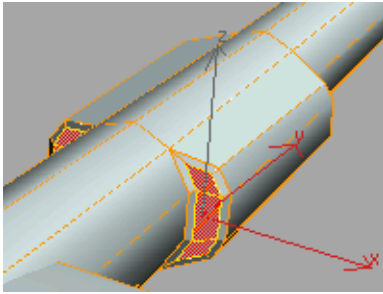

Inset creates new polygons from the current selection by offsetting their edges toward the inside.

- 13  Click the Settings button next to the Extrude tool in the Edit Polygons rollout.

The Extrude Polygons dialog appears.

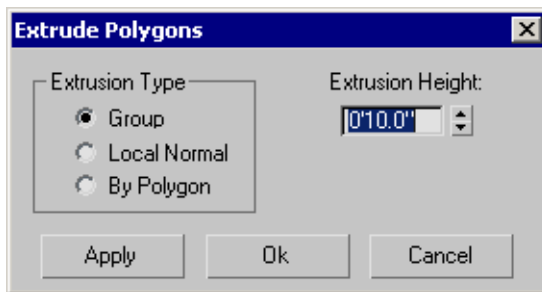

- 14 Set the Extrusion Height to **-5"** and click OK.

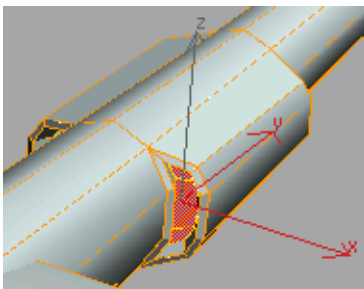

The air intakes are now complete. Next, you'll build some engine exhaust ports.

- 15 Save your scene as **mylightning02**.

Add engine exhaust ports:

Next, you'll add exhaust ports to either side of the forward section of the sponson near the propellers. Continue with the model you saved during the previous exercise, or open *low_poly_p38_03.max*. If you load this file, select the airplane, go to the Modify panel, and access the Polygon sub-object level of Editable Poly.

-  In the Top viewport, use Region Zoom to zoom into the right-side engine/propeller section.

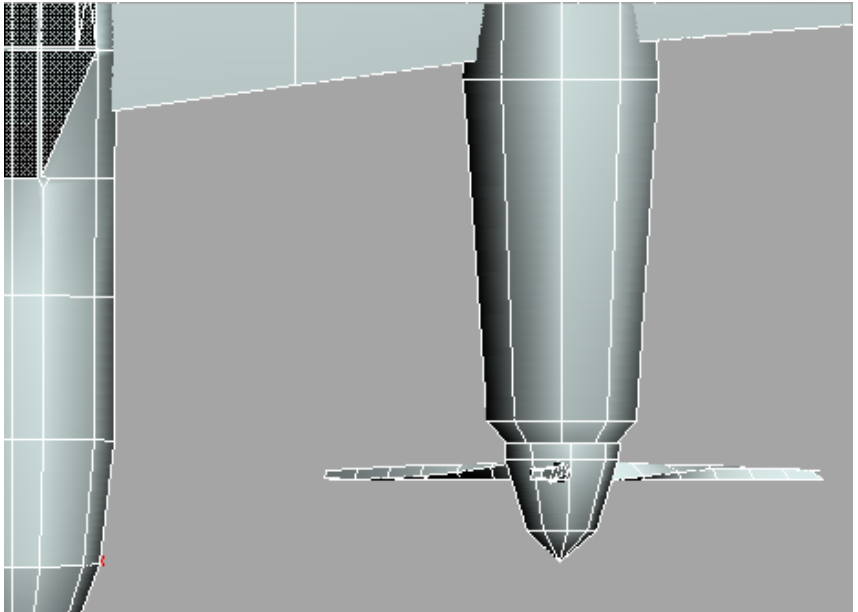

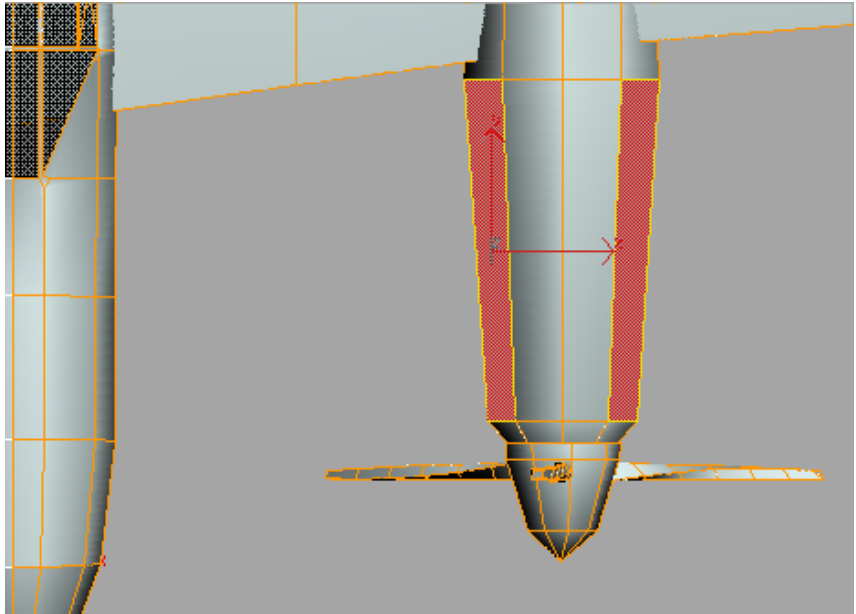

-  Make sure the Show End Result On/Off Toggle button at the bottom of the modifier stack is on.

-  Turn on Select Object and select the polygons at the left and right sides of the engine housing. If selected polygons do not appear in red, press the F2 key on the keyboard.

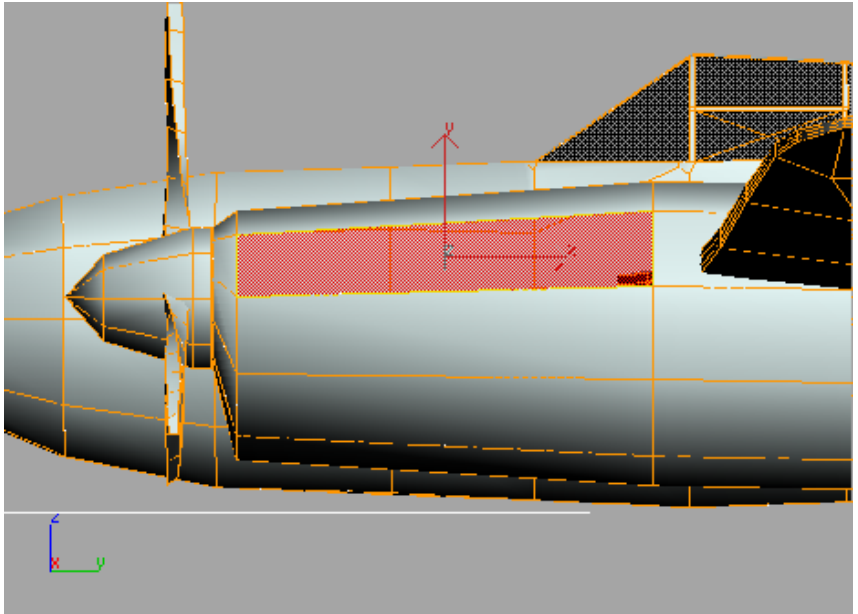

- 4  Activate the Right viewport and use Region Zoom to center the view around the engine section. If necessary, deselect polygons until only the topmost polygons on the engine housing are selected. Press F2 to display selected polygons in red.



- 5  Click the Settings button next to the Inset tool in the Edit Polygons rollout.
The Inset Polygons dialog appears.

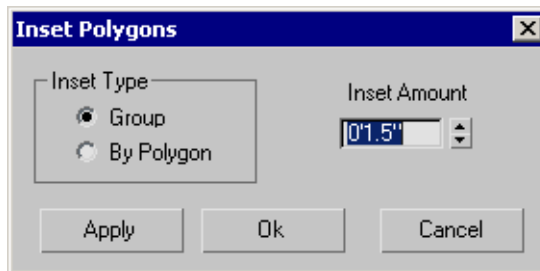

- 6 Set the Inset Amount to 3.5" and click OK.

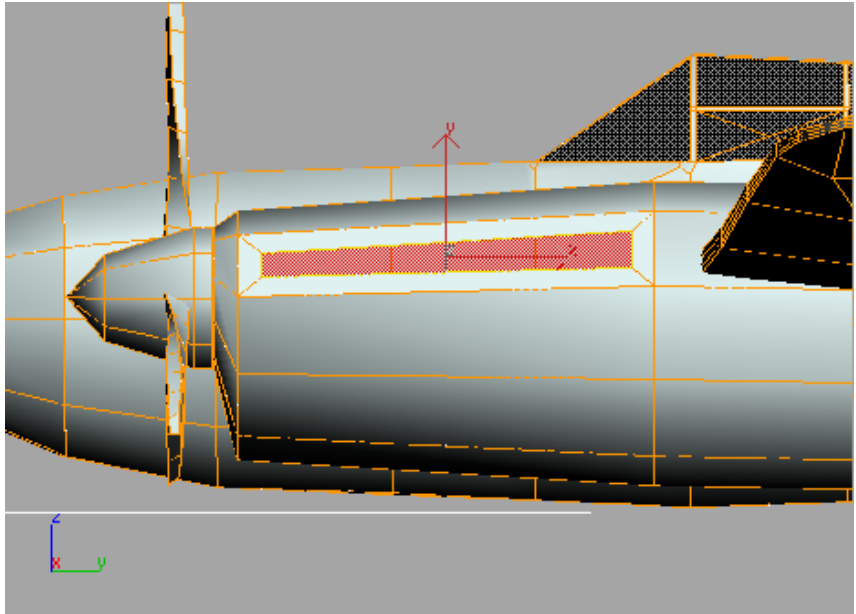

- 7 In the Top viewport, select only the inside polygon, as shown in the following illustration.

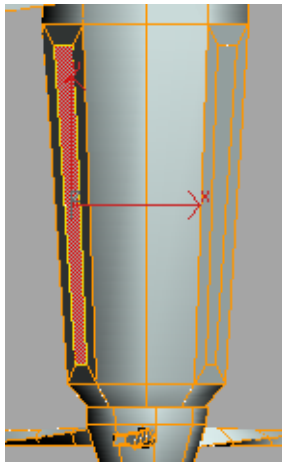

- 8  Click the Settings button next to the Hinge From Edge tool in the Edit Polygons rollout.

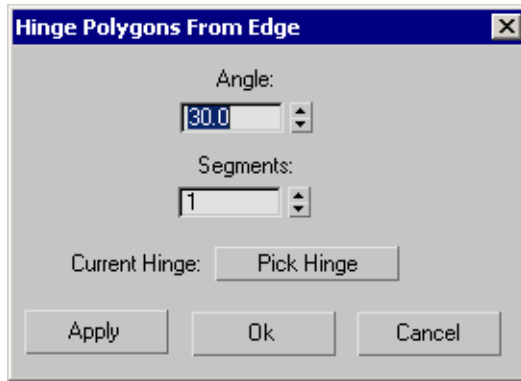

- 9 Click the Pick Hinge button. In the Top viewport, select the left edge of the selected polygon, as viewed from the top. From a “normal” orientation, this is the bottom edge.

The button text changes to *Edge 1051*. This will cause a hinged face to be created at this edge.

- 10 Set the Angle value to **45** and click OK. The hinged face is created.

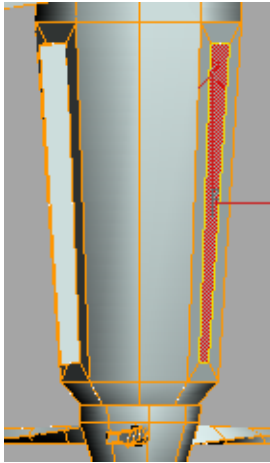

- 11 Select the outside polygon.
- 12 Repeat the Hinge procedure using the right edge, *Edge 1057*, as the hinge.
- 13 Save your scene as **mylightning03.max**.

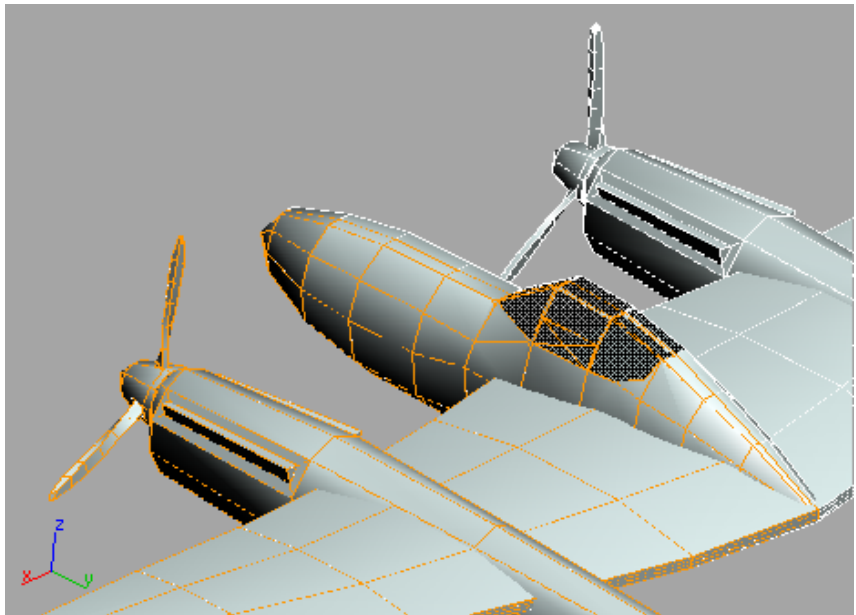

View of the engine exhaust ports you've added

Using Soft Selection

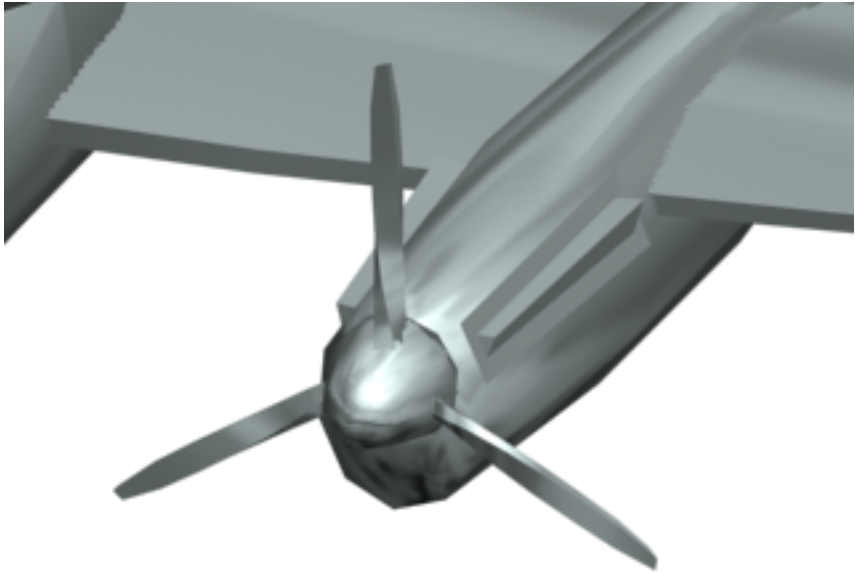

The original propellers on this model are a little too clunky-looking. In this lesson, you'll remove the existing propeller blades and replace them with new blades.

Set up the lesson:

- Open *low_poly_p38_04.max*.

Change the propellers:

- 1  In the Front viewport, use Zoom Region to center the view around the port engine of the airplane.

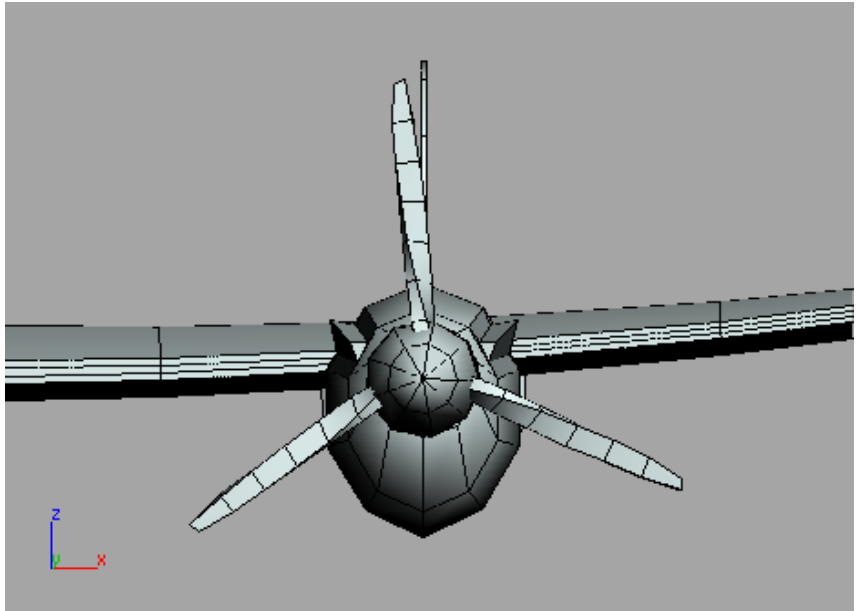

2 Select the *Lightning*.



3 Go to the Modify panel and pick the Editable Poly entry in the modifier stack.



4 Click the Show End Result On/Off Toggle button that is located along the bottom of the modifier stack.



5 From the Selection rollout, turn on the Element button and make sure Ignore Backfacing is on.

6 While holding down the Ctrl key, select each of the propeller blades.

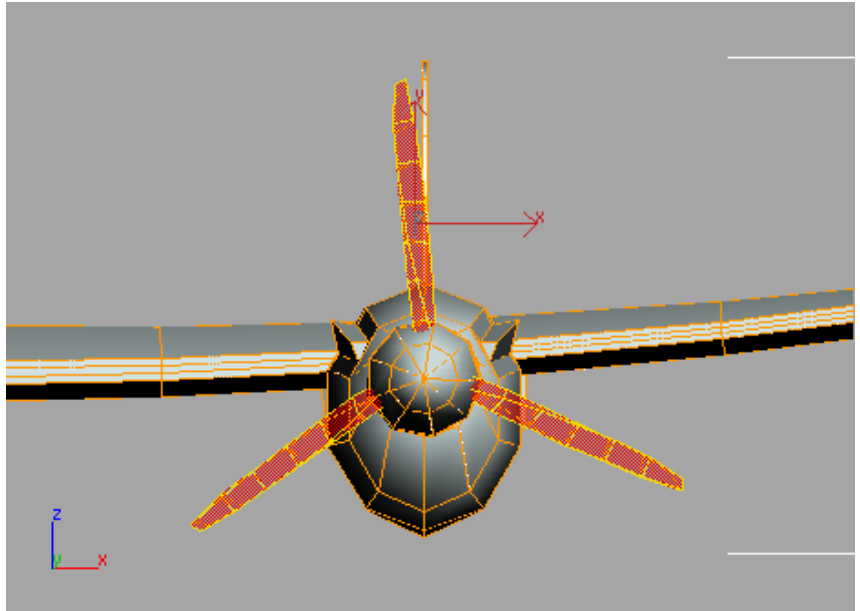

- 7 Click the Detach button on the Edit Geometry rollout and then click OK on the Detach dialog.

NOTE When you detach the propellers, they disappear from the opposite side of the airplane. This is because they are no longer part of the editable poly that has the Symmetry modifier applied to it.

- 8 Click the Editable Poly entry in the modifier stack to exit the sub-object level and then select the propellers.
- 9 Press the Delete key to remove the propellers you just detached.

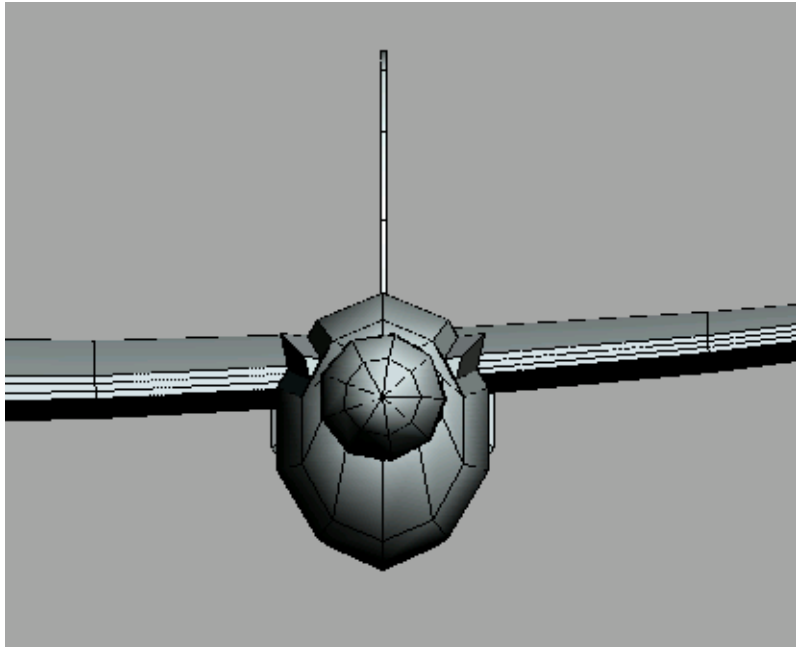

The Lightning has no propellers now.

Add the new propeller blades:

You'll use the Merge command to add a new propeller blade to your model.



- 1 From the Application menu, choose Import > Merge.
The Merge File dialog appears.
- 2 Browse to the `\modeling\p38_lightning` folder and double-click the file `newprops.max`.
The Merge – newprops.max dialog appears.
- 3 Select the `Blade01` object and click OK.

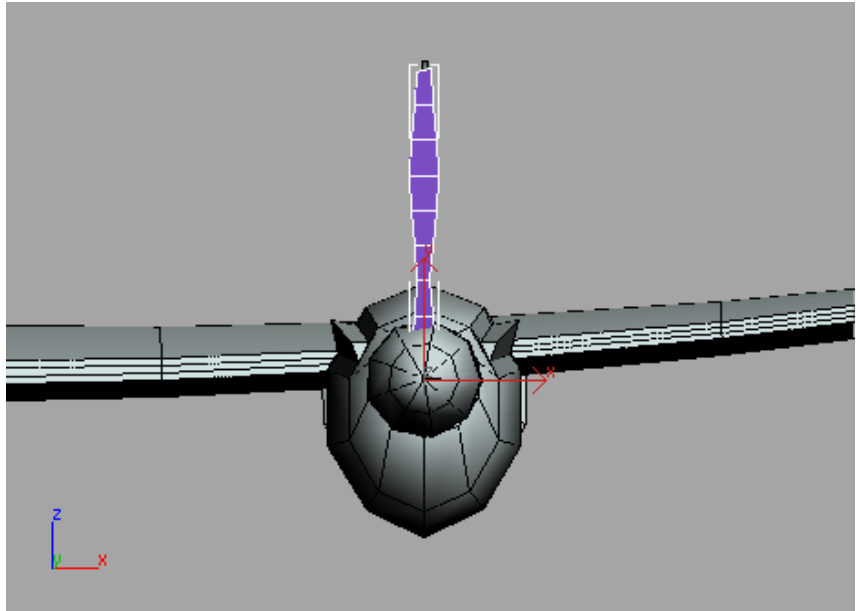

The new propeller blade appears in your scene.

- 4  Activate the Front viewport and then turn on Select And Rotate.
- 5 While holding down the Shift key, rotate the *Blade01* object around the Z axis to approximately **120** degrees.
The Clone Options dialog appears when you release the mouse button.

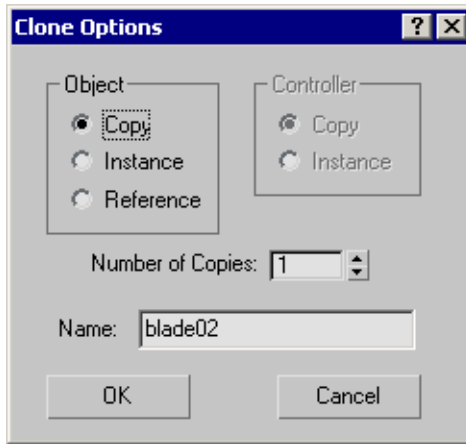

- 6 Set the Number Of Copies to **2** and in the Object group choose Instance. Click OK.

NOTE Using the Instance option is important, as you'll soon see.

Add a final touch for realistic propeller blades

Now that the new blades are in the scene, you'll twist the blades to make them look realistic. You'll use the Soft Selection feature to accomplish this.

Twist the blades:

- 1  Turn on Select Object. In the Front viewport, select the top propeller blade.

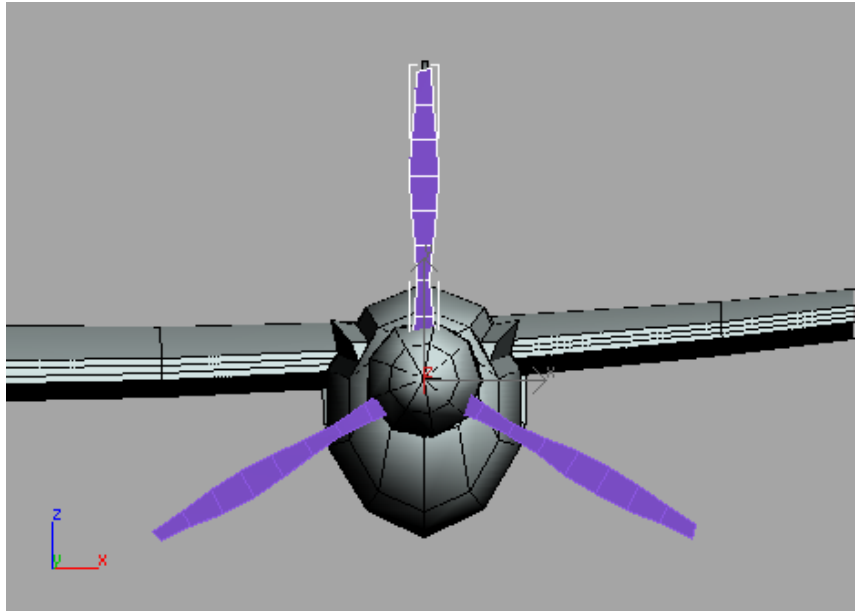

- 2 On the Modify panel, click the Vertex button in the Selection rollout.
- 3 Drag a window around the top set of vertices at the tip of the propeller blade.

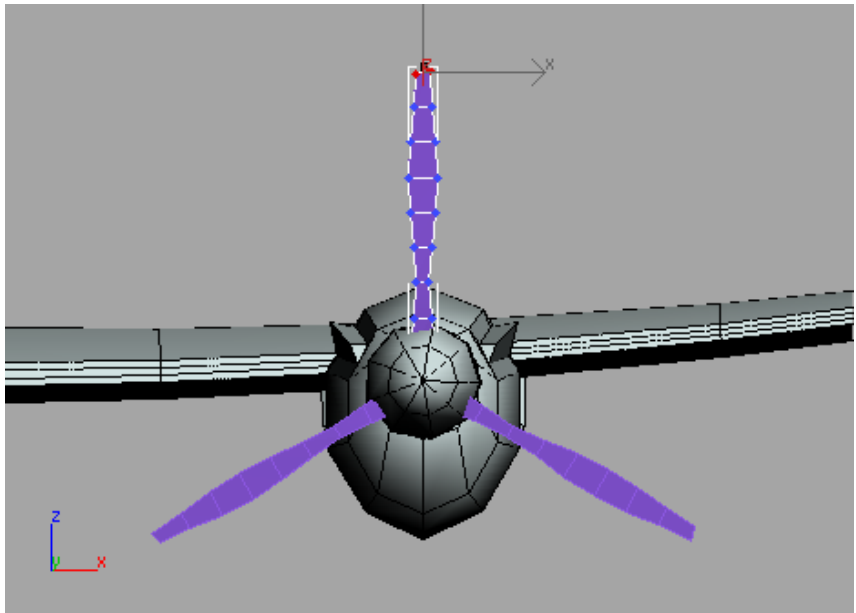

- 4 Open the Soft Selection rollout and turn on Use Soft Selection.
- 5 Drag or set the Falloff setting to 6'3".

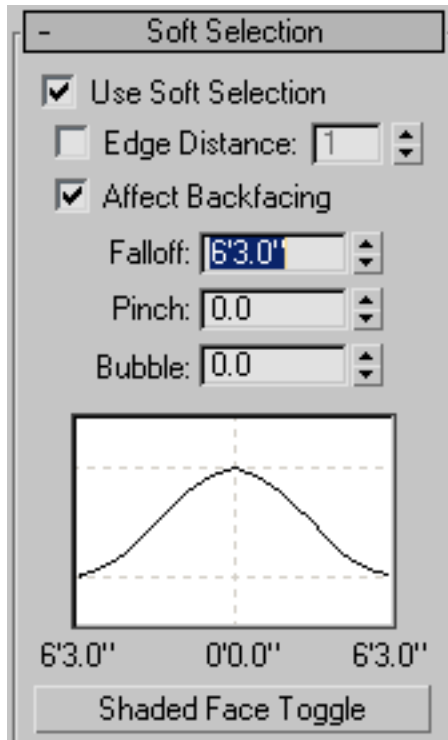

Notice what happens to the adjacent vertices as you increase the falloff. Vertices closest to the top will be affected more than the vertices that are further away.

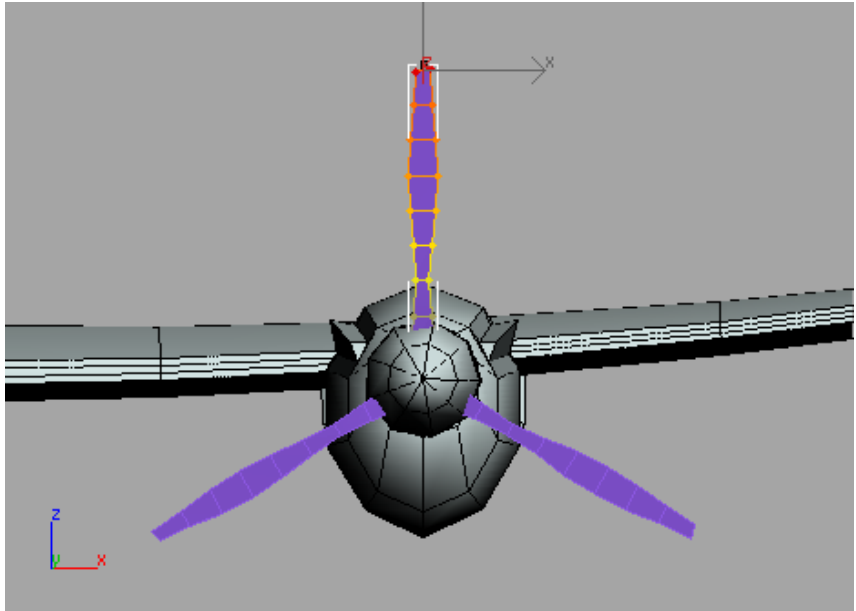

-  Turn on the Select And Rotate button and rotate the selected vertices around the Y axis to **-35** degrees.
Because the second and third blade are instances of the first, any change you make to the first blade affects the other two.

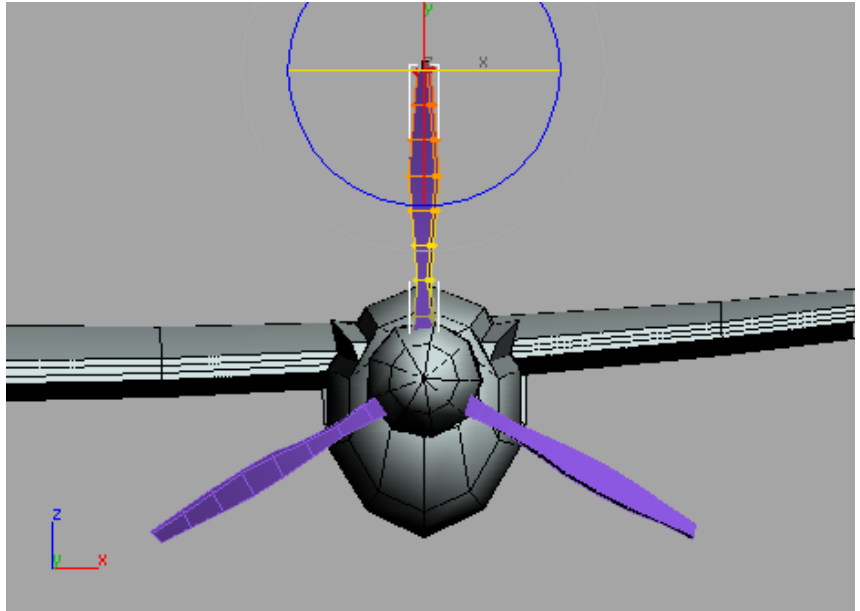

- 7 Click the Vertex button in the Selection rollout to exit Vertex sub-object level.



- 8 Turn on Select Object and select the *Lightning*.



- 9 Select the Editable Poly entry in the modifier stack and click the Attach List button, next to the Attach tool, in the Edit Geometry rollout. The Attach List dialog opens showing you the three propeller blades.

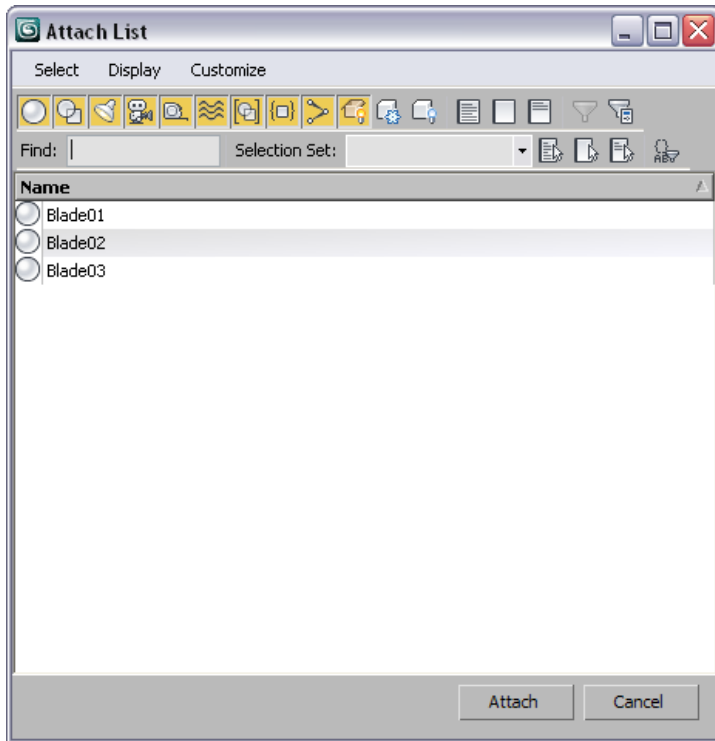

-  Click the Select All button on the Selection Set portion of the toolbar. Ctrl+click to deselect Scene root, and then click Attach.

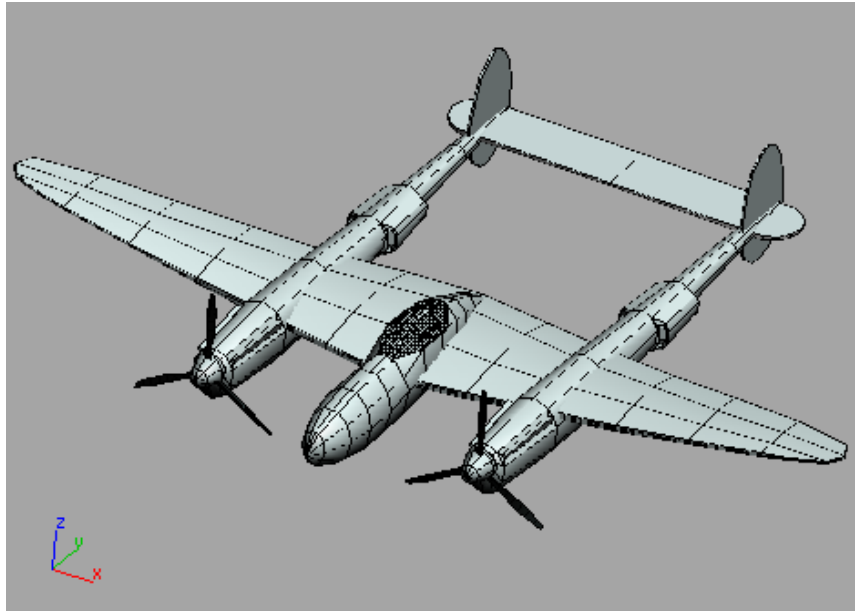

The blades are now attached to the rest of the airplane, and they are automatically added to the opposite half due to the Symmetry modifier.

- 11 Save your scene as **mylightning04.max**.

Using the HSDS Modifier

The HSDS (Hierarchical SubDivision Surface) modifier is a finishing tool rather than a modeling tool. It gives you the best result when working on low-polygon models, like the P-38 Lightning.

This lesson will give you a better understanding of HSDS modifier's use. You'll use the modifier on the tail of the airplane to give it a couple of levels of detail.

Set up the lesson:

- Continue with the model you saved during the previous exercise, or open *low_poly_p38_05.max* in the `\modeling\p38_lightning` folder.

Refine the rudder:

-  In the Right viewport, use Zoom Region to center the view around the rudder of the airplane.

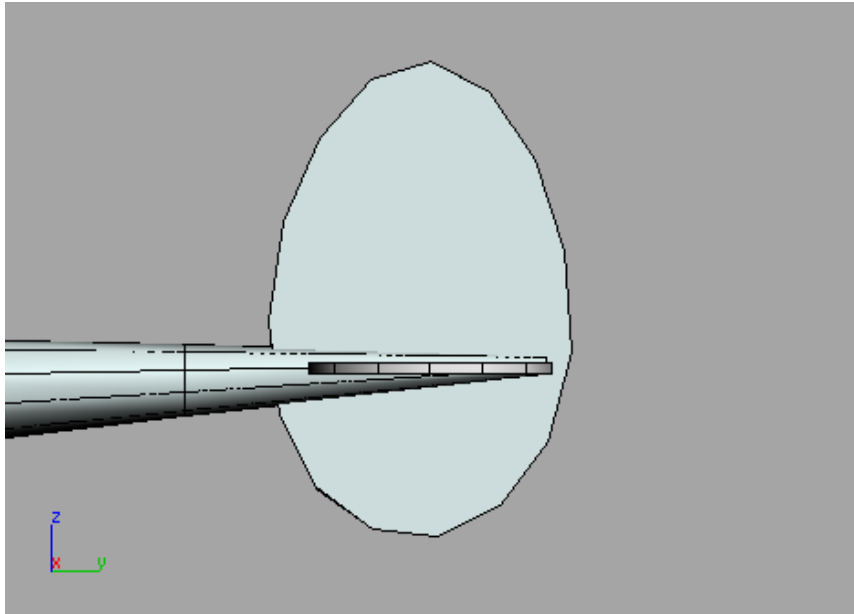

- Select the *Lightning*.

-  Go to the Modify panel and pick the Editable Poly entry in the Modifier stack.

-  Click the Show End Result On/Off Toggle button that is located along the bottom of the modifier stack.

- From the Modifiers menu, choose Subdivision Surfaces > HSDS Modifier

-  From the HSDS Parameters rollout, turn on the Element button. You'll see half of the airplane displayed in a yellow mesh.

- 7 Select the rudder element.

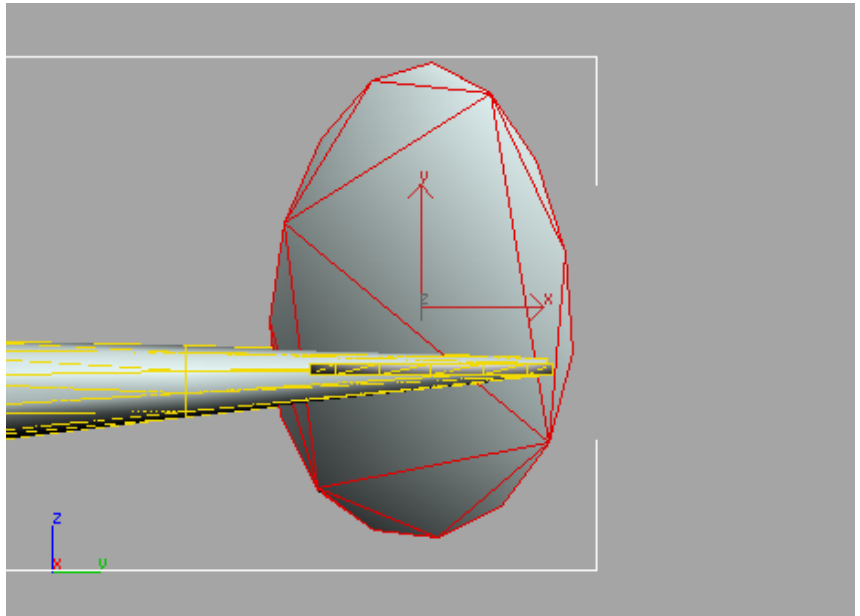

- 8 Click the Subdivide button under the level-of-detail display.

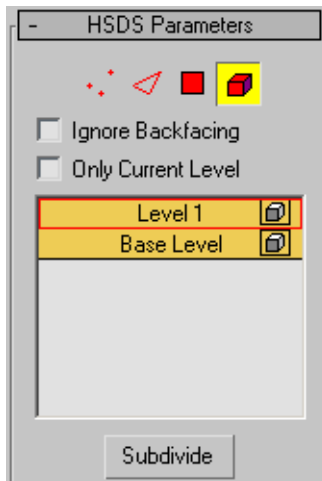

The rudder becomes more refined and the edges are much smoother. A level of detail, Level 1 is added to the level of detail list.

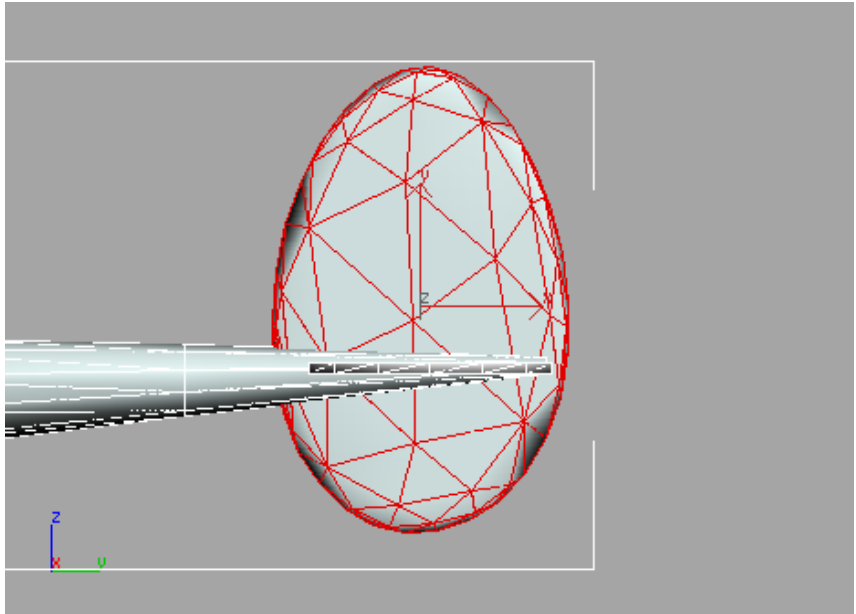

HSDS allows you to increase the mesh resolution of specific parts of the model instead of the entire model

- 9  On the HSDS Parameters rollout, turn on the Polygon button, then drag a selection window over the rear polygons on the rudder.

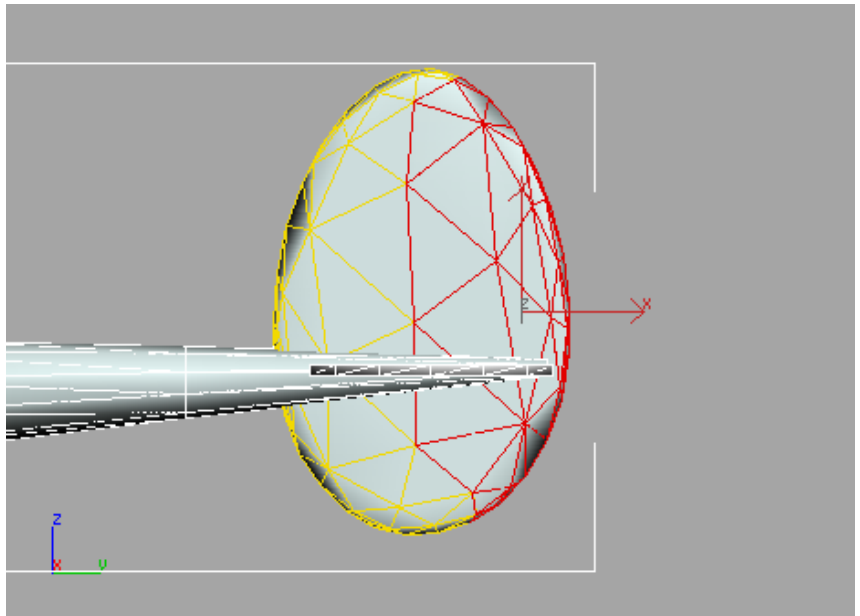

- 10 Click the Subdivide button again.

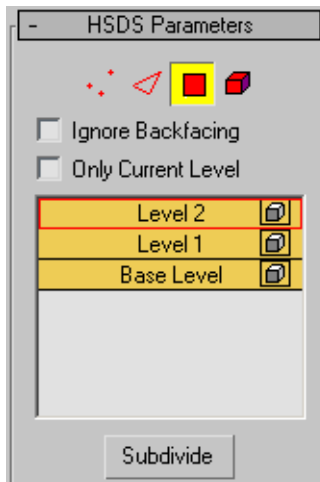

A second level of detail is added to the level of detail list and the rear part of the rudder is even more refined.

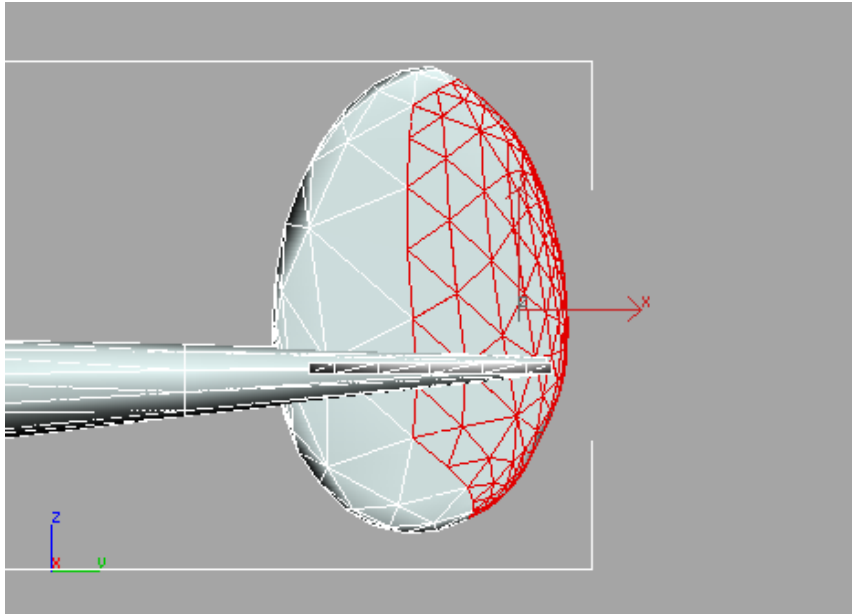

- 11 Click the display button next to the Base Level.
Level 1 and 2 are turned off and you see the original polygons you started with.

Using the Edit Normal Modifier

The Edit Normal modifier in 3ds Max was developed with game developers in mind. Now that many game engines and graphics hardware use pixel and vertex shaders, demand has increased to give modelers the ability to adjust normals interactively when looking at the result of a pixel vertex shader.

NOTE In order to see the results of using the Edit Normal modifier, 3ds Max should be configured for DirectX.

Set up the lesson:

- Continue with the model you saved during the previous exercise or open *low_poly_p38_06.max* in the *\modeling\p38_lightning* folder.

If you use the sample scene, some of the plane's components have been hidden for better performance. It's also been maximized to the Perspective viewport.

Adjust the normals on the wing:

- 1 Select the *Lightning*.



- 2 Open the Modify panel and unroll the Modifier List.

- 3 Click Edit Normals.

The normals are indicated by the blue lines that suddenly sprout from the model. The dark blue color tells you the normals are Unspecified and are calculated based on the smoothing groups of surrounding faces.

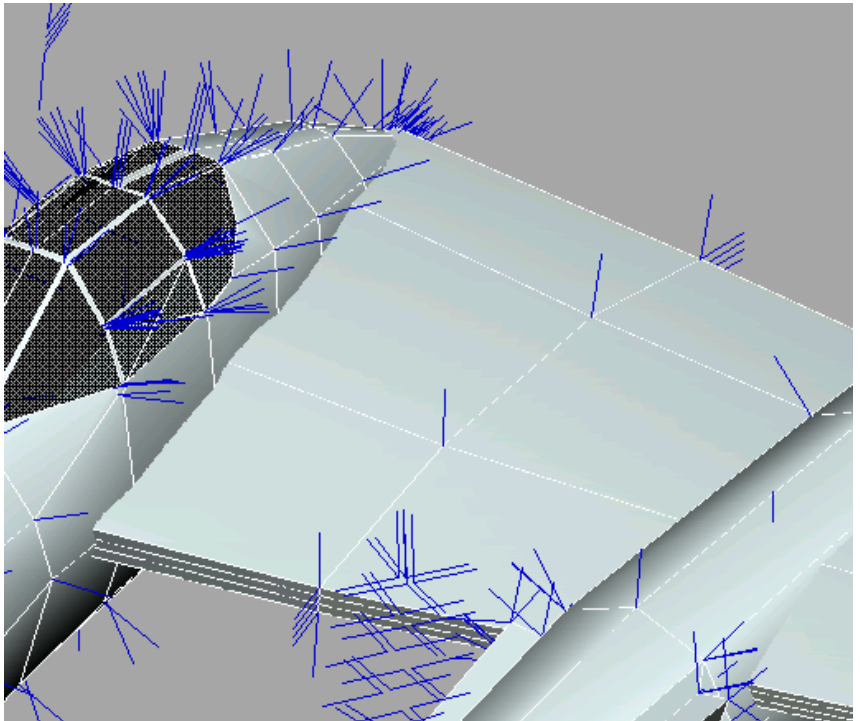

- 4 Select Normal 194.

This normal is in the middle of the wing between the cockpit and sponson.

You can also see which normal you've picked by looking at the display at the bottom of the Parameters rollout.

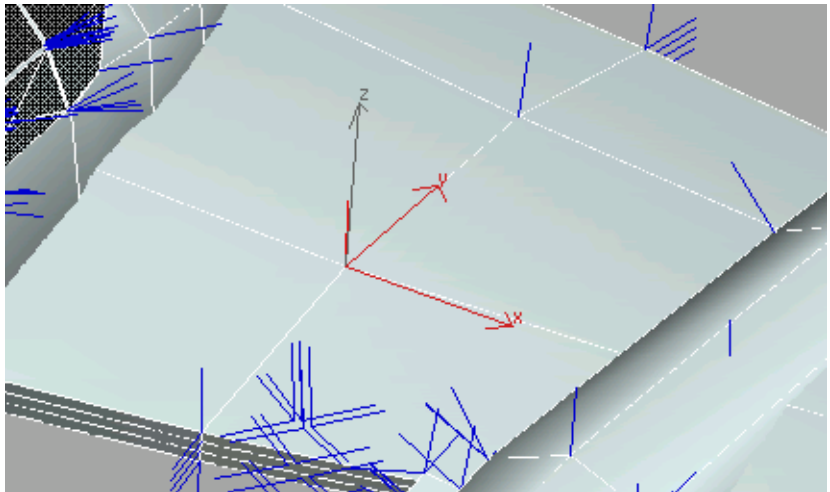

- 5  Rotate the normal. Notice the effect different rotations have on the surface of the airplane.

The surrounding surfaces get lighter or darker depending on how you rotate the normal.

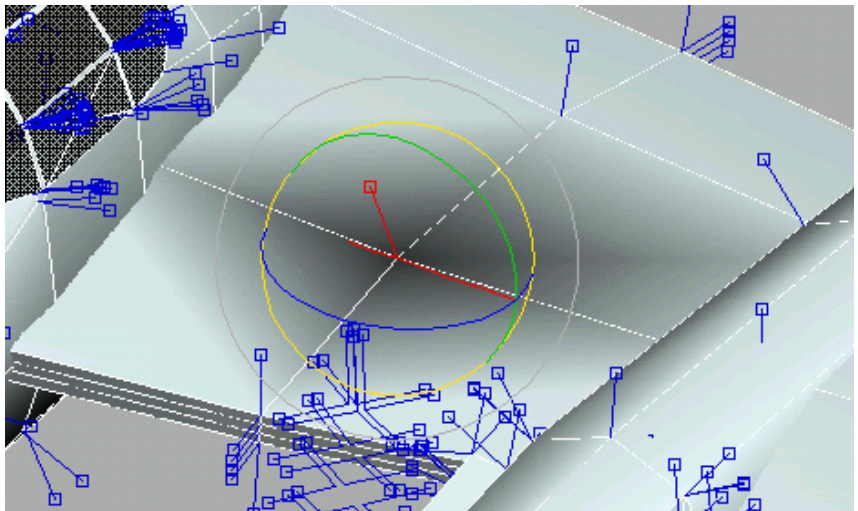

NOTE Once you make a manual change to the original orientation of the normal, the normal changes to a green color, signifying that it's now an Explicit normal.

- 6 Experiment by selecting some of the other normals, or try working with groups of normals to see how they respond.

Summary

You have learned about several powerful features that will improve your modeling skills. The Editable Poly object is very versatile, and works with many modifiers to help you shape an object exactly as you like.

Modeling a Low-Poly Character

This tutorial steps you through the process of modeling a character, starting with conventional box modeling of primitive objects and shape extrusion, followed by Edit Poly modifiers and edge modeling techniques to fine tune the result.

What is Considered Low-Poly and Optimizing Where it Matters

As technology leaps exponentially forward and rendering engines display more and more polygons in real time, what was once called low-poly might not quite be so today. Conservatively speaking, a low-polygon character ranges between 500 and 2,500 faces, depending on the platform the game is aimed for, the game engine used, the number of characters onscreen simultaneously, the level of detail, and so on. For example, characters featured in a fighting game require more details than a swarm of army grunts charging a castle in a strategy game. Often in the game industry, strict polygon budgets are established at the beginning of a project; going over the limit could lead to complications down the line, such as memory-allocation problems.

New techniques like [normal bump mapping](#) on page 1244 are designed to go hand-in-hand with low-polygon models. By combining them, you can have incredible-looking models with a tenth of the expected number of faces.

Features Covered in This Section

- Box modeling of primitive objects
- Symmetry and Edit Poly modifiers

- Shape extrusion and vertices insertion
- Edge modeling techniques
- Poly count optimization
- Meshsmooth and Turbosmooth modifiers

Modeling a Low-Poly Body

This tutorial demonstrates how to model a character similar to those found in today's video games. You will explore a variety of modeling techniques, starting with what is commonly called "box modeling." This means constructing your model from a simple polygon box. You can model just about anything using this method.

You will also make extensive use of the editable poly object and Edit Poly modifier. You will also use the Symmetry modifier to help reduce modeling time and effort.



In this tutorial, you will learn how to:

- Create various complex, organic forms from simple objects such as primitives and extruded shapes.
- Use the Symmetry modifier to create a mirror duplicate of half of the model.
- Transform editable poly sub-objects to fine-tune the model shape.
- Insert vertices to add resolution where needed.

Skill level: Intermediate

Time to complete: 6–8 hours

Setting Up the Scene

Before you begin creating a 3D model, whether a character or any other object, you first need to research the object you wish to create. In this tutorial, you will be modeling a helicopter pilot for a war game.

To research this subject, you can consult books and use Internet search engines. You might also take snapshots of a figurine from a toy store.



Even better, if you can draw, you can create custom illustrations for use as reference when building the character.

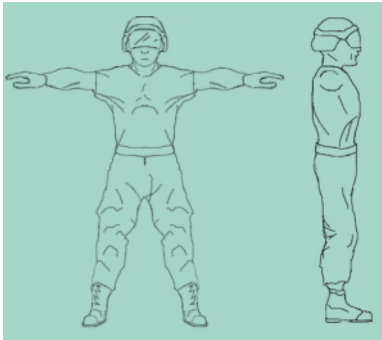

Creating a Virtual Studio

Before you begin, note the resolution (in pixels) of the reference images you've created. If you are using the reference files that have been provided for this tutorial, their resolutions are as follows:

Top reference image: **385 (width) x 200 (height)**.

Front reference image: **385 (w) x 440 (h)**.

Side reference image: **200 (w) x 440 (h)**.

Create a reference plane:

- 1 Start 3ds Max. Click anywhere in the Top viewport to activate it.
- 2 From the Create menu, choose Standard Primitives > Plane.
- 3 In the Top viewport, click and drag an area of any size.

- 4  Go to the Modify panel. On the Parameters rollout, set Length to **200** and Width to **385**.

- 5 Set both Length Segs and Width Segs to **1**.

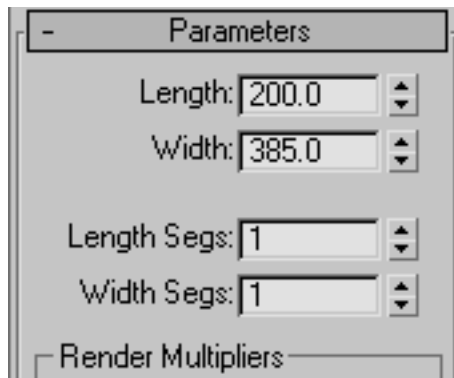

- 6  On the main toolbar, click the Move button.
- 7 On the status bar, set the position values in X, Y, and Z to **0.0**. This places the plane's pivot point at the world origin.

TIP One easy way to set a numeric field to 0.0 (or its lowest allowable value) is to right-click its spinner arrows.

Map a reference image:

- 1 Press M to open the Material Editor.

- 2 On the Blinn Basic Parameters rollout, set the Self-Illumination value to 100.



This lets you see the map without any help from scene lights.

- 3 Click the map button next to the Diffuse color swatch.
- 4 On the Material/Map Browser that appears, double-click Bitmap to choose this type of map.

This opens the Select Bitmap Image File dialog.

- 5 Browse to the `\sceneassets\images` folder and choose *soldier-top.jpg*. Click Open to close the dialog.

- 6  Click the Show Standard Map In Viewport button to toggle it on.

- 7  With the plane object still selected, click the Assign Material To Selection button to apply the newly created material to the plane.

You can now see the material on the plane in the Perspective viewport.

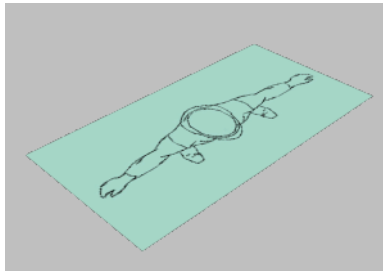

Create additional reference planes:

Now that you have created the top-view plane, you'll repeat the procedure to create an additional plane based on the front view, and another one based on the left view. The sizes of these planes should reflect the sizes of the reference images to be assigned to them. Therefore, the plane you build in the Front viewport should be 440 units long by 385 units wide, and the plane you build

in the Left viewport should be 440 units long by 200 units wide. Remember to center each plane and to use a new sample slot in the Material Editor for each new material. When you are done, the Perspective viewport should look like this:

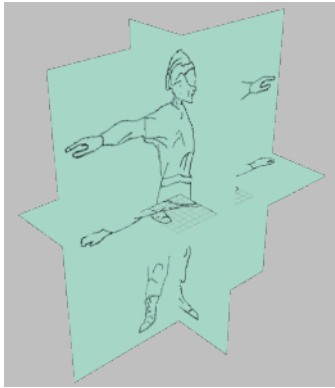

Adjust the virtual studio:

Before you can start modeling the character, you need to adjust the positions of the three reference planes.

- 1 Activate each viewport in succession and press G to turn the grid off. Currently, only the Perspective viewport is shaded.
- 2 Make sure every viewport is shaded by first activating it and then pressing the F3 keyboard shortcut.
- 3 Select the top reference plane in the Perspective viewport. Using the Move tool, move the plane downward on the Z axis (blue axis) until it is at the bottom of the other two planes.

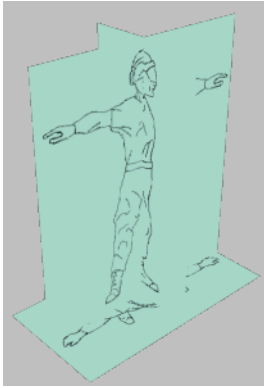

- 4 Select the side reference plane in the Perspective viewport.
Notice that the height of the helmet in this reference plane differs from its height in the front reference plane.
- 5 Move the side plane upward on the Z axis so that the helmets' heights match. You can keep an eye on the pilot's belt as well.
- 6 Move the side reference plane on the X axis (red axis) to the right edge of the virtual studio.

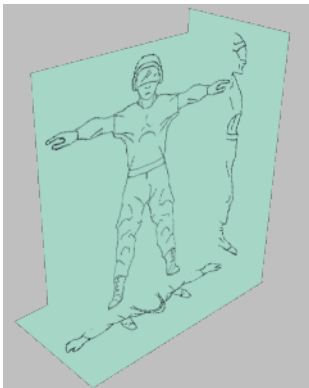

- 7 Finally, select the front reference plane and move it on the Y axis to the back edge of the virtual studio.

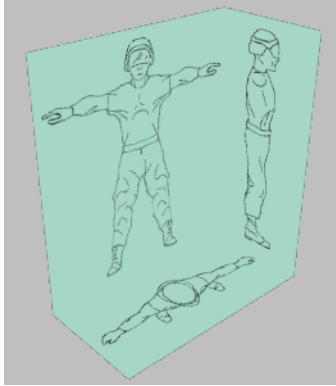

Freeze the reference planes:

Now that the reference planes are in place, you'll freeze them to prevent accidentally moving them.

- 1  Select all three of the reference planes and go to the Display panel.
- 2 On the Display Properties rollout, turn off Show Frozen in Gray.

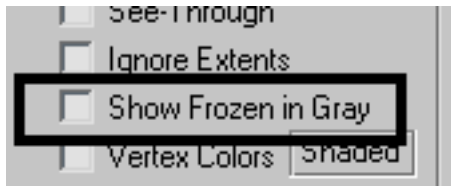

NOTE Leaving this option on would turn the planes dark gray after freezing them, preventing you from seeing the reference images. In the case of a virtual studio, you want to disable this option.

- 3 Expand the Freeze rollout and click Freeze Selected.
- 4 Save your file, naming it **My_Virtual_Studio.max**.

Creating the Boots

In this lesson, you create the boots of the helicopter pilot by using a simple box primitive. You then convert the box to editable poly format and start sculpting the boot using sub-objects such as vertex, edge and polygon.

Create a box primitive:

- 1  Continue working on your file from the previous exercise, or on the Quick Access toolbar, click the Open File button, navigate to `\scenes\modeling\low_polygon_modeling` and open `virtual_studio.max`.

- 2  In the Left viewport, Zoom in on the pilot's foot.
- 3 From the Create menu, choose Standard Primitives > Box.
- 4 Create a box to use as a heel. Set Length to **6.0** and both Width and Height to **18.0**.



- 5  In the Top viewport, move the box so that it is aligned with the pilot's right foot, toward the left side of the viewport. If necessary, adjust the Height value of the box to correspond to the width of the foot in the reference image.



- 6 Right-click the box and choose Convert to > Convert To Editable Poly from the quad menu.

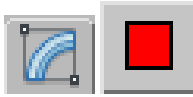

- 7 Go to the Modify panel, then turn on the Polygon button to work at the Polygon sub-object level.
- 8 In the Top viewport, click the side of the box facing you. The top polygon on the box highlights in red.
- 9 Press the Spacebar to lock your selection.



NOTE Alternatively, you can lock the selection by clicking the Lock Selection toggle on the status bar.

- 10 On the Edit Polygons rollout, click the Extrude button.
- 11 In the Left viewport, click and drag to extrude the selected polygon until it is just below the ankle.

TIP To better visualize the geometry structure, press F4 to turn on Edged Faces display. Do this in all viewports.



- 12 Press the Spacebar again to unlock the selection so you can select a different polygon.
- 13 In the Front viewport, click the upper polygon representing the foot.



- 14 On the Edit Polygons rollout, click the Extrude button again, and then click and drag the selected polygon to extrude it until it reaches the ball of the foot. Keep an eye on the Left viewport for reference.



- 15 In the Left viewport, scale the selected polygon slightly on the vertical (Y) axis.



- 16 Move the selected polygon downward to place its bottom edge level with the ground.



- 17 In the Front viewport, scale the selected polygon up horizontally.



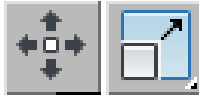

- 18** Perform one additional extrusion to create the toes. Use Move and Scale on the various axes to adjust the selected polygon so it resembles the following illustration.

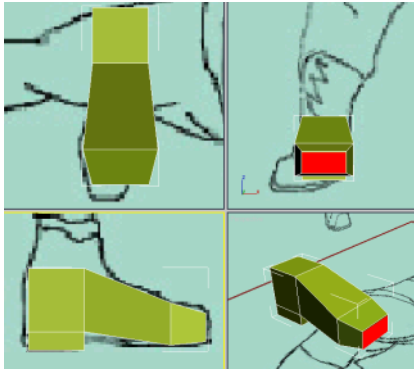

- 19** In the Top viewport, select the polygon at the rear of the foot.

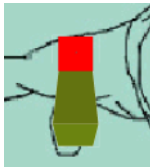

- 20** Extrude the selected polygon to the ankle level.



- 21** On the Edit Polygons rollout, click Bevel. Drag the selected polygon upward to perform a regular extrusion, and then release the mouse button move the mouse upward slightly to make the polygon bigger. Keep an eye on the reference image in the viewport.



The bulk of the work is done, but you still need to refine the boot to make it look better.

Refine the boot:

- 1 Continue working on your file.



- 2 On the Selection rollout, click Edge.

- 3 In the Perspective viewport, select one of the vertical edges near the ball of the foot or the toes.

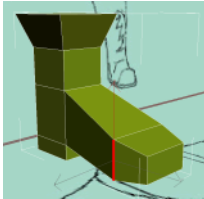

- 4 On the Selection rollout, click the Ring button.
All edges around the foot are selected.

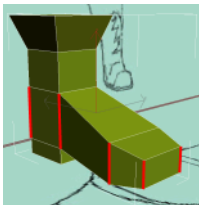

- 5 On the Edit Edges rollout, click the Connect button.
This creates an extra division running horizontally through the previously selected edges.

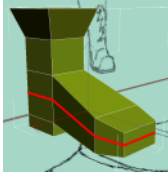

- 6 Scale the selected edges uniformly larger by a small amount (about 108%) to tone down the boxy look of the foot.

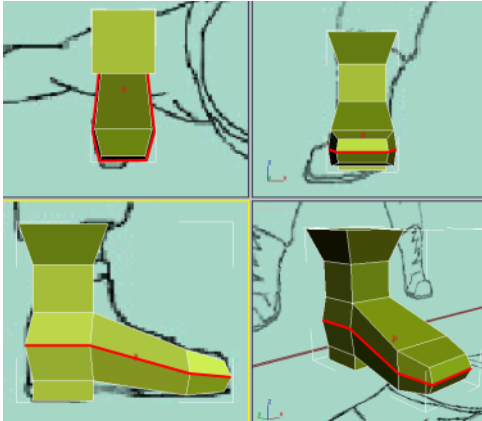

- 7 In the Perspective viewport, click the ViewCube left or right arrow twice to view the back of the boot.
- 8 Select the top edge at the rear of the boot.

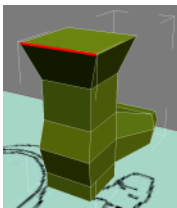

- 9 Press and hold the Ctrl key and then click the down spinner of the Ring tool. With each click, an additional edge is selected around that ring. Keep clicking until all the horizontal edges running down the back side of the boot are selected.

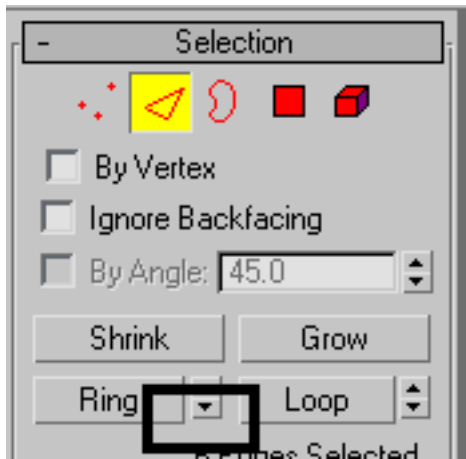

- 10 On the Edit Edges rollout, click Connect.
A new vertical division goes through the previously selected edges.

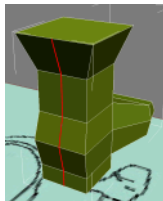

- 11 In the Top viewport, move the selected edges upward on the vertical axis (Y) so that the back of the boot is slightly more rounded.

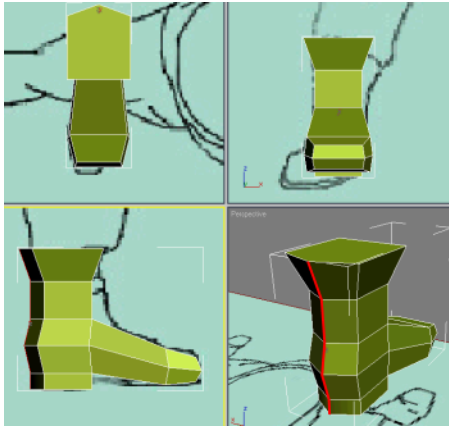

- 12 If you have time, continue refining the boot. However, do not overdo it, as you do not want to have too many polygons in the model.

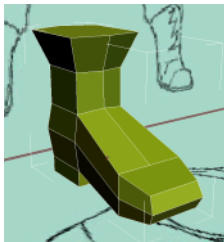

Finalize the boot:

- 1 Continue working on your file.



- 2 On the Modify panel, exit the sub-object level.
- 3 From the Modifier List, choose the Bend modifier.
- 4 Set Bend Axis to Y and Direction to **90.0**.

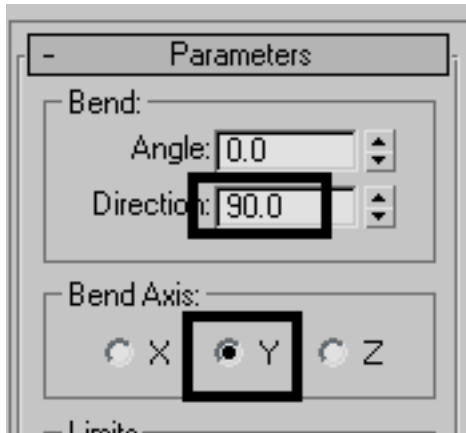

- 5 Adjust the Bend Angle so that the boot is oriented with the reference image. An Angle value of -17 to -18 degrees should be adequate. You might want to rotate the boot slightly in the Top viewport as well.

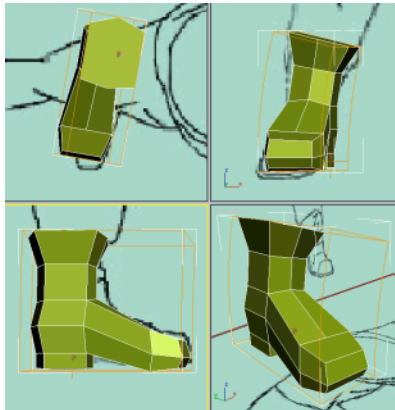

- 6 Rename the object **Boot-Right**.

Mirror the boot:

- 1 Continue working on your file.
- 2 Right-click the Front viewport to activate it.



- 3 On the main toolbar, activate the Mirror tool.

- 4 Leave the Mirror Axis set to X and set Clone Selection to Instance.
- 5 Click OK to create the instanced, mirrored clone and close the dialog.



- 6 Use the Move tool to position the new boot based on the reference image.



- 7 Rename the clone **Boot-Left**.
- 8 Save your file as **My_Soldier_Boots.max**.

Creating the Pants

In this lesson, you create the pants for the helicopter pilot. As with the boots, you'll base the pants on a primitive; this time a cylinder. You'll create one leg first and then use the Symmetry modifier to create the other leg.

Creating a leg:

- 1 Continue working on your file from the previous exercise, or load the file *soldier01.max* from `\modeling\low_polygon_modeling`.



- 2 In the top viewport, zoom in on the pilot's right foot.
- 3 From the Create menu, choose Standard Primitives > Cylinder.
- 4 In the Top viewport, create a cylinder centered on the right boot.

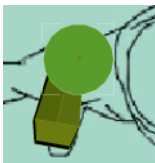

- 5  Go to the Modify panel. Set the cylinder Parameters as follows:
Radius: **20**
Height: **20**
Height Segments: **1**
Sides: **8**
Smooth: **Off**
- 6 In the Left viewport, move the cylinder downward until it intersects slightly with the boot.
- 7 In the Front viewport, rotate the cylinder so that it is aligned with the pants leg in the reference image.

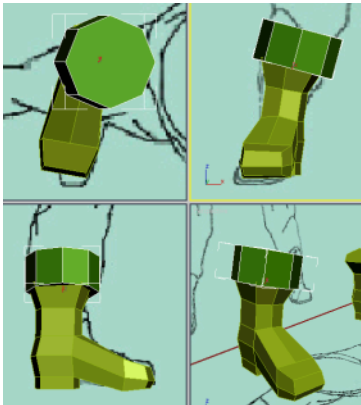

- 8  On the main toolbar, click Select And Uniform Scale, then set the Reference Coordinate System to Local.
- 9 In the front viewport, scale the cylinder on its local X axis so that it better fits the reference image.

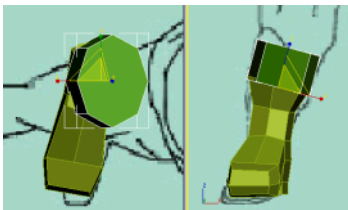

- 10 Right-click the cylinder in any viewport and choose Convert To > Convert To Editable Poly.



- 11 On the Modify panel, click the Polygon sub-object level button.
- 12 In the Top viewport, click the cylinder's top polygon.
- 13 On the Edit Polygons rollout, click the Extrude button.
- 14 In the Top viewport, drag the selected polygon to extrude it by about half the original height.



- 15 Use Move and Scale to fit the selected polygon to the reference image in the various viewports.

IMPORTANT Make sure that Local is the coordinate system for both Move and Scale. You have to set it the first time you turn on each different kind of transform.

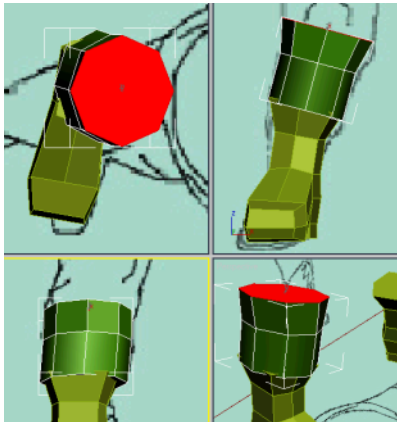



- 16** Perform another extrusion to right below the knee. Again, use the transform tools such as Move and Scale to match the polygon to the reference image. You might also want to use Rotate.



Joints such as knees and elbows require additional detail so they deform properly when animated.

- 17** Add two more extrusions to complete the knee, adjusting each as you go.

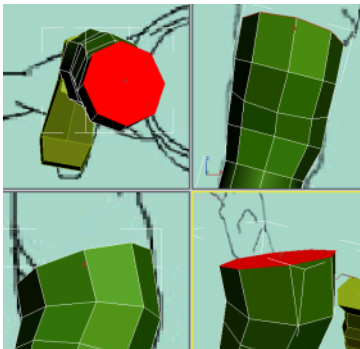

- 18** Add one extrusion to create the thigh, and another all the way to the hip joint. You can add more detail later if you miss a spot.

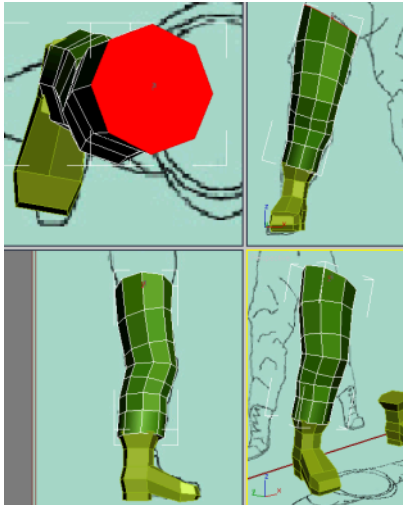

- 19** Add two more extrusions to provide the necessary mesh resolution for the hip joint.



- 20** Add another extrusion to reach the lower part of the belt. Use the transform tools to align the polygon with the belt line. Don't worry about the right side; applying the Symmetry modifier will take care of that.

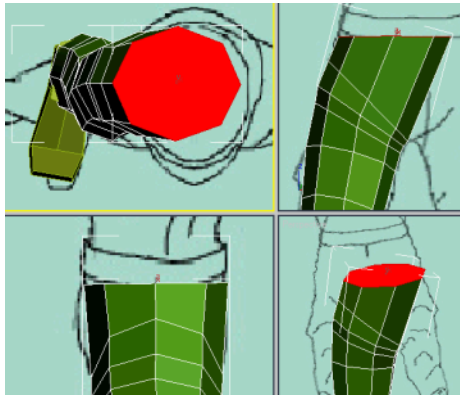

- 21 Add one final extrusion for the belt.
 Before you apply a Symmetry modifier to create the opposite leg, you need to adjust the buttocks area, which is too flat at the moment.



- 22 On the Selection rollout, click the Edge button.



- 23 In the Left viewport, select any of the vertical edges below the belt.

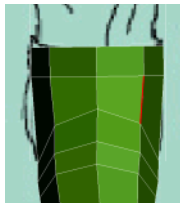

- 24 On the Selection rollout, click the Ring button to select all edges parallel to the selected one.
 25 On the Edit Edges rollout, click Connect. This adds a series of edges connecting the selected ones.



- 26 On the Selection rollout, click Vertex.
 27 In the Left viewport, drag a region selection of vertices around the buttocks and then adjust their positions.

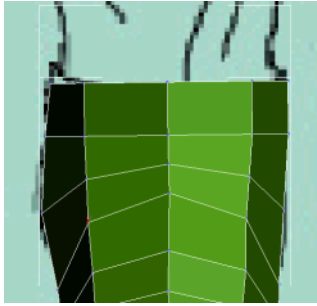

28 Exit the sub-object level when done.

Use the reset XForm utility:

Before you apply a Symmetry modifier to create the other leg, you'll use the Reset XForm utility to reset all rotation and scale transforms on the existing object. Failing to do so would result in faulty symmetry planes.



1 In the Modify stack, click the Editable Poly entry to exit sub-object editing.



2 With the pants-leg object selected, go to the Utilities panel.

3 Click the Reset XForm button to open the Reset Transform rollout, and then click Reset Selected.



4 Go back to the Modify panel.

The modifier stack now contains a new XForm modifier that incorporates all the rotation and scale transforms.

- 5 Collapse the stack by right-clicking the leg in the viewport and choosing Convert To > Convert To Editable Poly.

Use the Symmetry modifier:



- 1 Make sure the leg is selected. On the Modify panel, open the Modifier List and choose Symmetry.
- 2 In the modifier stack, expand the Symmetry modifier and click Mirror. This sub-object level lets you transform the plane about which the symmetry occurs.

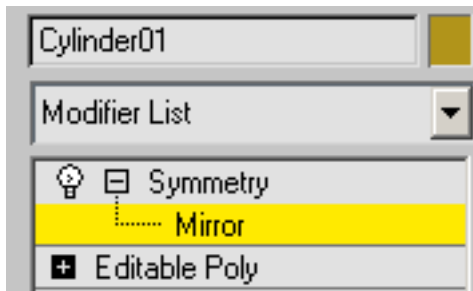

- 3 In the Parameters rollout, leave Mirror Axis set to X and turn on the Flip option.

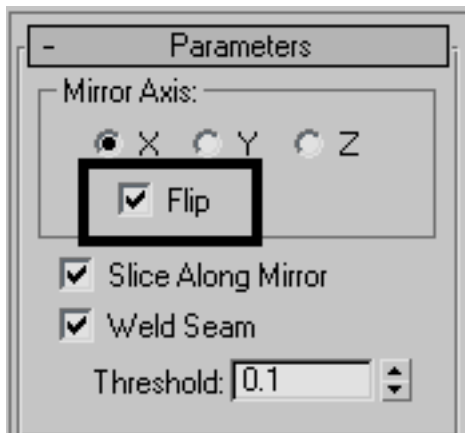

- 4 In the Front viewport, move the Mirror plane on the X axis so that the symmetrical leg is in the right place.



- 5 Exit the Mirror sub-object level when done.

The pants are almost done. You still need use the Edit Poly modifier to fine-tune the area around the hips.

Use the Edit Poly modifier:



- 1 Make sure the leg is selected. On the Modify panel, open the Modifier List and click Edit Poly.

- 2 In the Perspective viewport, zoom in on the front of the belt.



- 3 On the Selection rollout, click the Edge button.



- 4 Select the center edge of the belt.

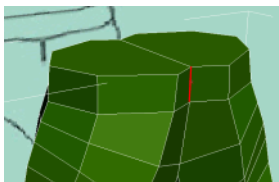

- 5 Press and hold Ctrl and then click the Loop spinner up-arrow twice. This expands the selection by two adjacent edges.



- 6  In the Top viewport, move the selected edges on the Y axis so that you get a smooth curve instead of an inverted V.

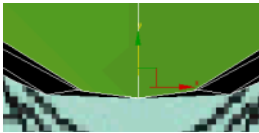

- 7  Similarly, adjust the edges on the back side of the pants.

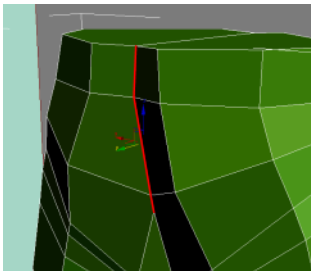

- 8 Continue fine-tuning the area around the hips. For better control, try alternating between Edge and Vertex sub-object levels.

- 9  At the Edge sub-object level, choose one vertical edge on the belt line.
- 10 On the Selection rollout, click Ring to select all vertical edges around the belt.



- 11 Press and hold Ctrl, and then click the Polygon button to convert the edge selection to a poly selection.

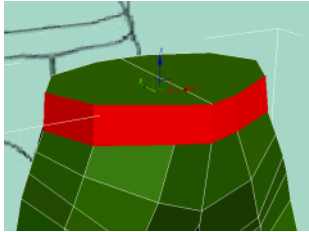

- 12 On the Edit Polygons rollout, click the Extrude Settings button. This opens the Extrude Polygons dialog.
- 13 Set Extrusion Type to Local Normal and the Extrusion Height to 1.5.

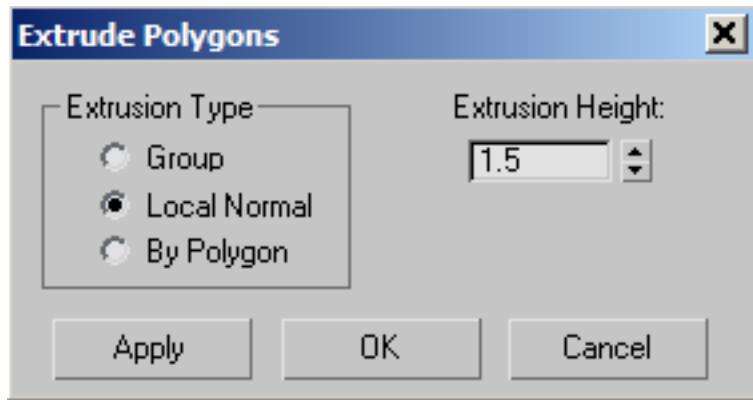



- 14 Click OK to apply the changes and close the dialog.

Remove unwanted polygons:

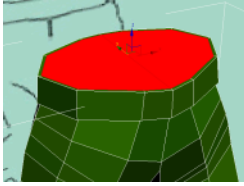

- 1 Select the two polygons at the top of the pants.



-  On the Edit Polygons rollout, click the Inset Settings button. This opens the Inset Polygons dialog.
- Set the Inset Amount value to **5.0**, and then click OK to accept the changes and close the dialog.
- Press Delete to eliminate the selected polygons.

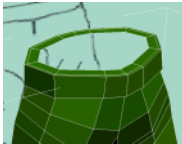

- Repeat the previous steps to inset and then delete the polygons at the bottom of the pants legs.

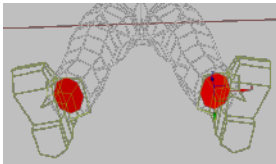

- Exit the sub-object level. On the Modify panel, rename the object **Pants**.
- Save the file as **My_Soldier_Pants.max**.

Creating the Torso

In this lesson, you create the torso for the helicopter pilot: mostly the T-shirt he's wearing. In previous exercises, you started with simple primitives such as a box or a cylinder and you mostly extruded polygons to modify the shape. In this exercise, you'll use a slightly different approach. You'll start with an

even simpler primitive, a plane object, but you'll do most of the work using edge sub-selection. This method of modeling is powerful and intuitive.

Create the T-shirt

- 1 Continue working on your scene from the previous exercise, or load the file *soldier02.max* from `\modeling\low_polygon_modeling`.



- 2 In the Front viewport, zoom in on the pilot's midsection.

- 3 From the Create menu, choose Standard Primitives > Plane.

- 4 Drag in the Front viewport to create a plane object.
You'll expand this object into a T-shirt.



- 5 On the Modify panel, set Length to **20.0**, Width to **12.0** and set Length Segments and Width Segments both to **1**.



- 6 Position the plane so that it intersects slightly with the belt and with the symmetry plane.

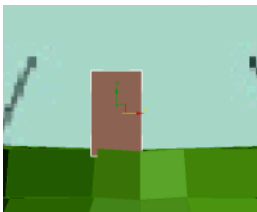

- 7 In the Top viewport, move the plane to the front section of the pants.

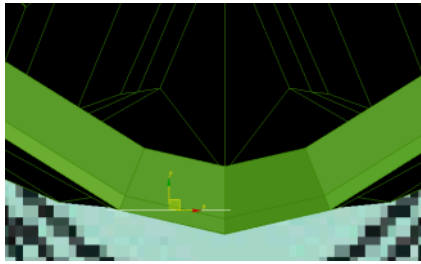

8 Convert the plane to editable poly format.



9 On the Modify panel > Selection rollout, click the Edge button.



10 In the Front viewport, select the top edge of the plane.



11 In the Left viewport, move the selected edge slightly to the left to conform to the reference image.

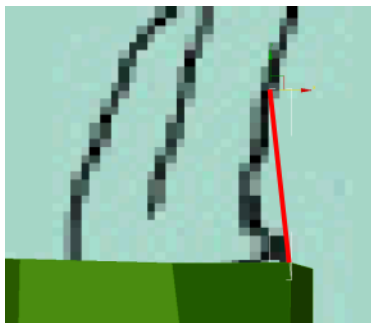



NOTE Because the plane appears as a line in the Left viewport, it takes some practice to properly visualize where the selected edge is at any given point. The transform gizmo is always useful for finding a selection.

- 12 Press and hold the Shift key, and then move the selected edge up and to the right to extrude it once, always conforming to the reference image.

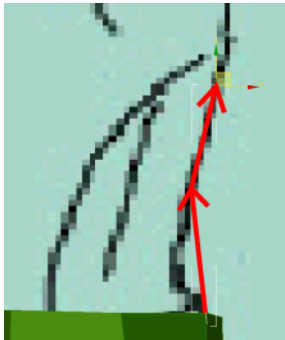

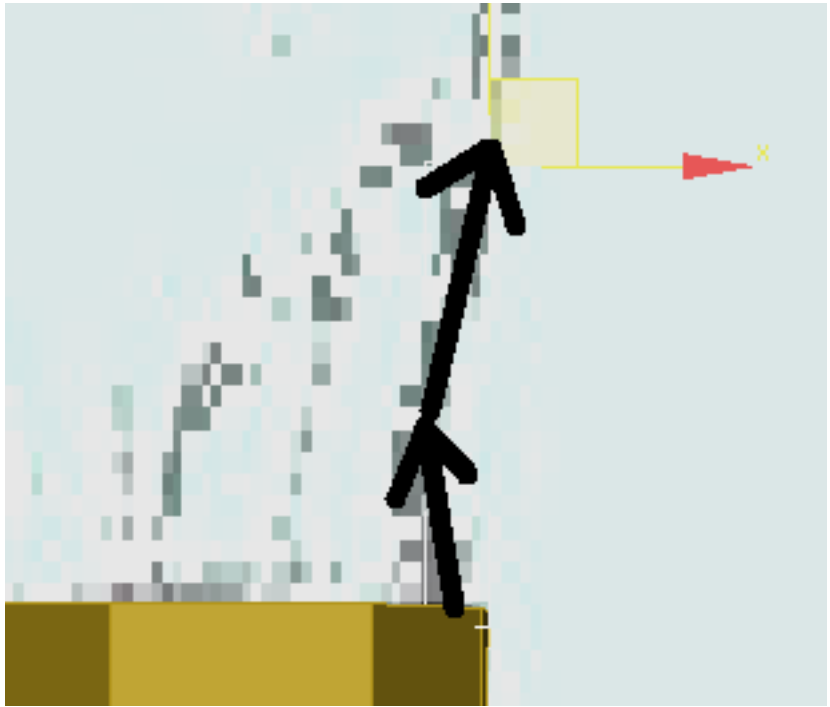

- 13 Continue using Shift+Move to extrude the selected edge around the profile silhouette of the helicopter pilot.

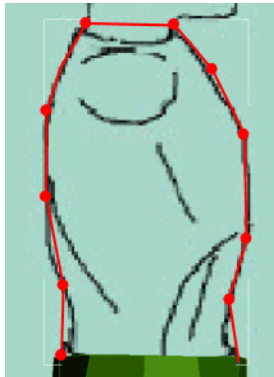

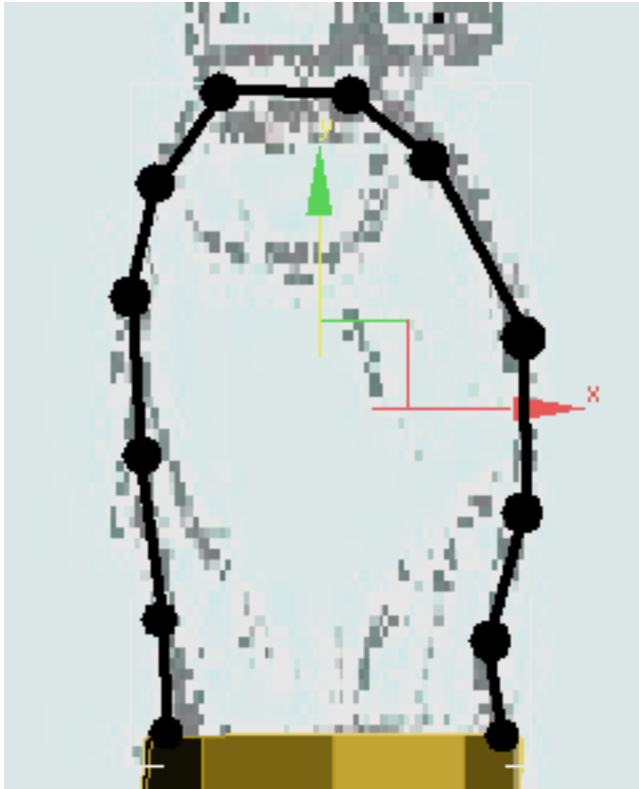

Edit the T-shirt:



- 1 Ensure that you're still at the Edge sub-object level.
- 2 In the Front viewport, select any of the vertical edges on the left side of the plane.
- 3 Click the Loop button to select all the edges on the left side of the plane.
- 4 Hold down the Shift key and then move the selected edges to the left by about the same amount as the original width.

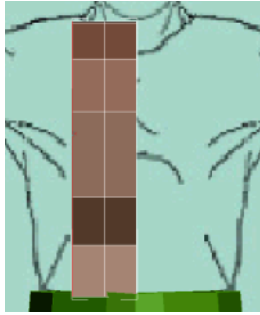

- 5 In the Top viewport, scale the selected edges on the vertical axis to bring them closer together.

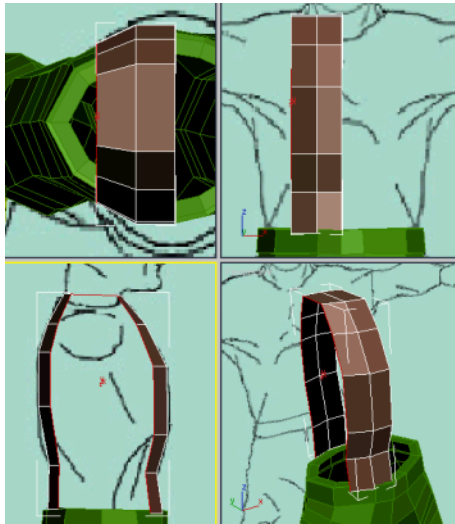

- 6 Repeat the previous two steps to create an additional edge extrusion, as shown in the following illustration.

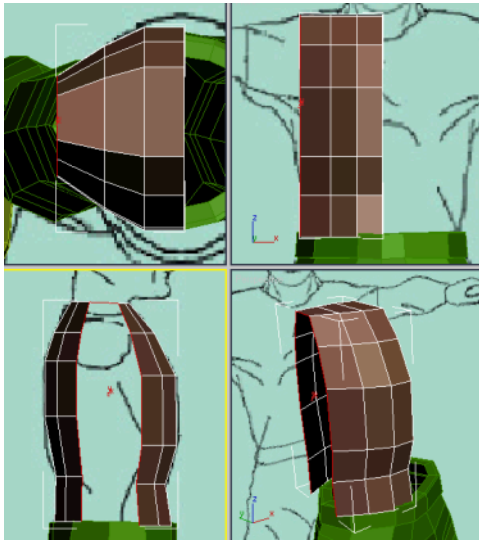

- 7 In the Left viewport, select the inner vertical edges, just above the belt line.



- 8 On the Edit Edges rollout, click the Bridge button.
A new polygon connects the two edges.

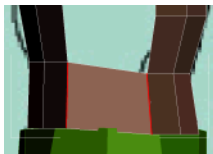

- 9 Repeat the procedure for two more levels of edges to bridge.



- 10  Switch to the Vertex sub-object level. Use the Move tool to fine-tune the position of the vertices, based on the reference images.

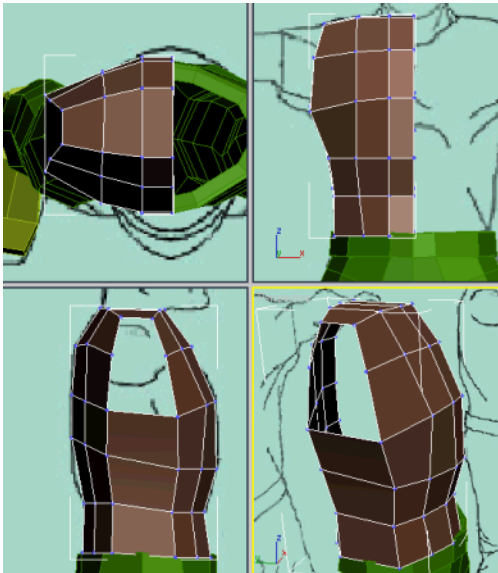

Create the sleeve:

- 1  On the Selection rollout, turn on the Border sub-object level.
- 2 Click one of the edges around the sleeve opening. Because Border is active, 3ds Max selects the whole perimeter.



- 3 In the Front viewport, use Shift+Move to create two extrusions that will make up the sleeve.



- 4 In the various viewports, adjust vertex positions so the shape of the sleeve matches the reference images.

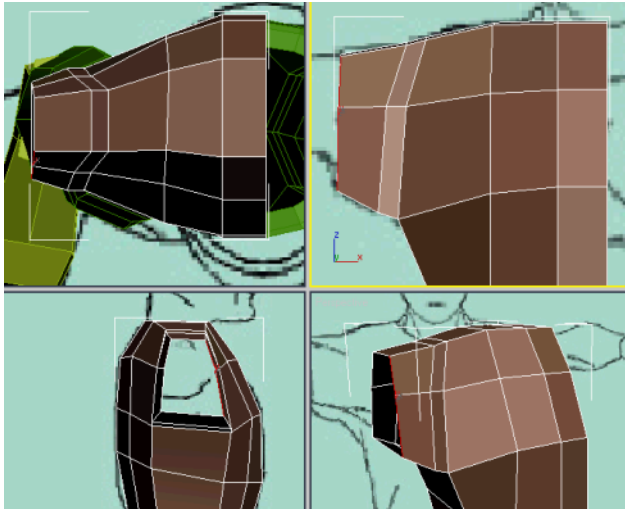

Add detail:



- 1 Go to the Edge sub-object level.
- 2 Select an edge under the armpit.
- 3 Click the Ring button to expand the selection.



- 4 On the Edit Edges rollout, click Connect to add a line of edges connecting the previously selected edges.



- 5 Adjust the positions of the edges and vertices to get a better sleeve opening.

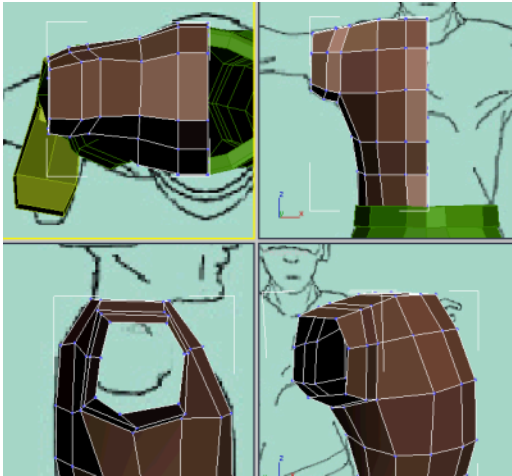

Create the collar:



- 1 Make sure you're still at Edge sub-object level.



- 2 In the Top viewport, select the edges shown in the following illustration:



3 Connect the selected edges.

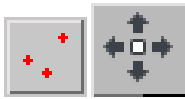

4 Switch to the Vertex sub-object level. Use the Move tool to fine-tune the shape of the collar based on the reference images.

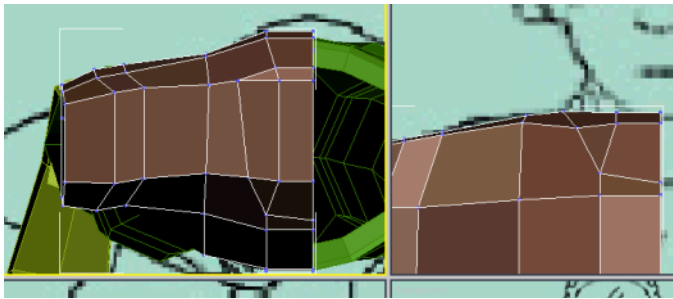

5 Go to the Polygon sub-object level.



6 Select the polygons above the collar line.

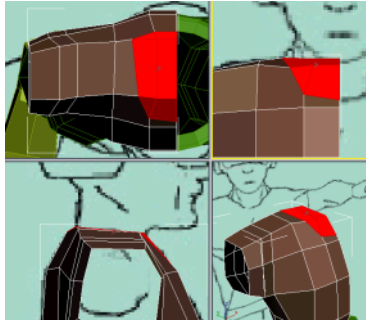

- 7 Press Delete to remove the unwanted faces.
- 8 Exit the sub-object level.

Add a Symmetry modifier:



- 1 Go to the object level by clicking Editable Poly in the modifier stack. Make sure the partially built T-Shirt is selected.
- 2 Apply a Symmetry modifier.
- 3 Leave Mirror Axis set to X and turn on the Flip option.
- 4 In the modifier stack, expand the Symmetry modifier and click Mirror to highlight it.
- 5 In the Front viewport, move the mirror line to the right until you get a properly adjusted T-Shirt.

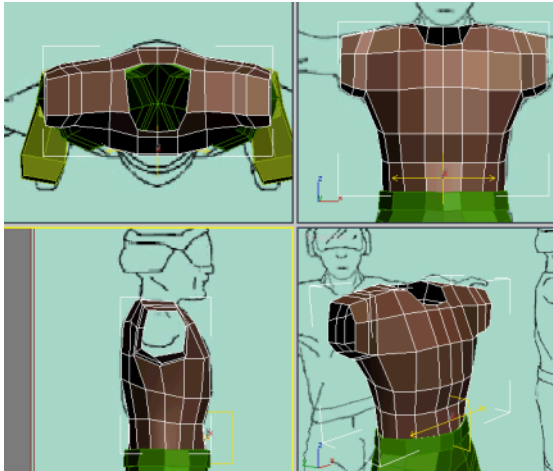

- 6 Exit the Mirror sub-object level and rename the object: **Shirt**.
- 7 Save your file as **My_Soldier_Tshirt.max**.

Creating the Arms

In this lesson, you create the arms of the helicopter pilot. For the upper arm and forearm, you can use the same modeling techniques that you used to model the pants; that is, using a cylinder and extruding polygons. To create the hand, you can build it based on a Box primitive. Later, you will attach the hand to the arm and connect the gap using the bridge tool.

Create the arm:

- 1 Continue working on your file from the previous exercise, or load the file *soldier03.max* from `\modeling\low_polygon_modeling`.



- 2 In the Left viewport, zoom in on the T-Shirt sleeve.

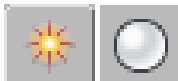

- 3 Create a Cylinder centered on the sleeve. Set the parameters as follows:

Radius: **12**

Height: 30

Height Segments: 1

Sides: 6

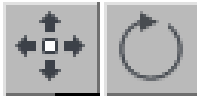

- 4 Move and rotate the cylinder so that it's oriented with the sleeve and protrudes slightly from the sleeve.

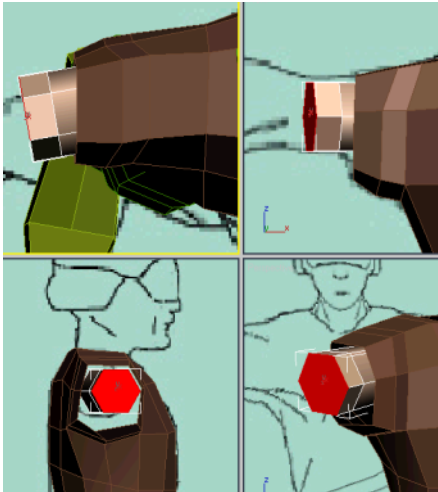



- 5 Convert the cylinder to editable poly format.



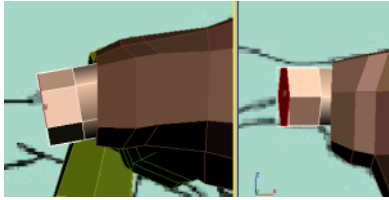

- 6 Go to the Polygon sub-object level.
- 7 In the Left viewport, select the hexagon facing you.
- 8 On the Edit Polygons rollout, click Extrude. Drag the selected polygon to create an extrusion for the biceps.

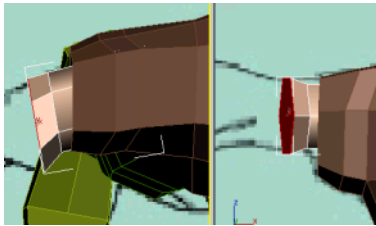

- 9   Using Move and Scale, adjust the biceps to make them bigger than the beginning of the arm.



- 10    Create another extrusion to close the biceps near the elbow. Use the Move, Rotate, and Scale tools to adjust the polygon at that level.

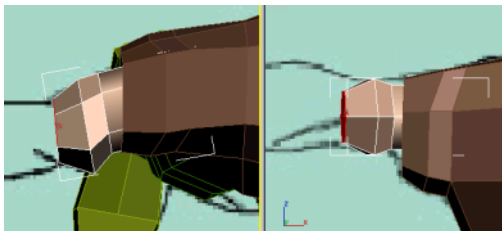

- 11 Create an additional extrusion for the elbow. The extra edges allow the elbow to deform properly when you animate the character.

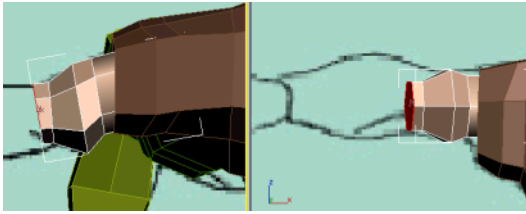

- 12 Create two more extrusions to create the forearm. Adjust them to fit the reference images.





- 13  Right-click the Front viewport to activate it, and zoom in on the arm.
- 14 Press F3 to set the viewport to wireframe display.

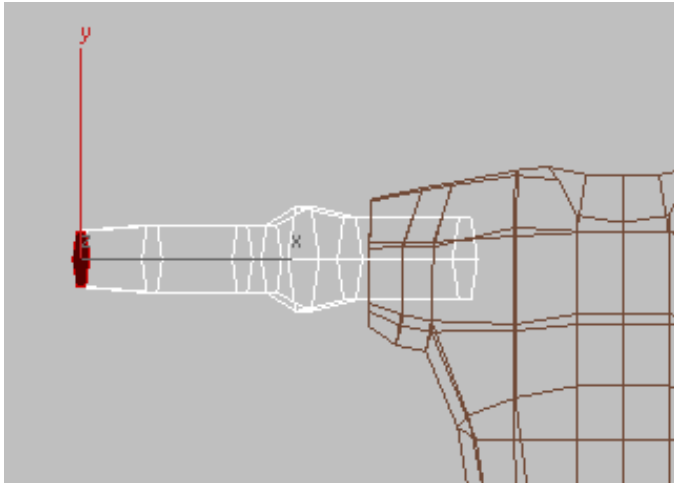

Notice the arm inside the sleeve.



- 15  On the Selection rollout, go to the Vertex selection level.

- 16  Adjust the vertex positions to get a better flow between the arm and the sleeve.

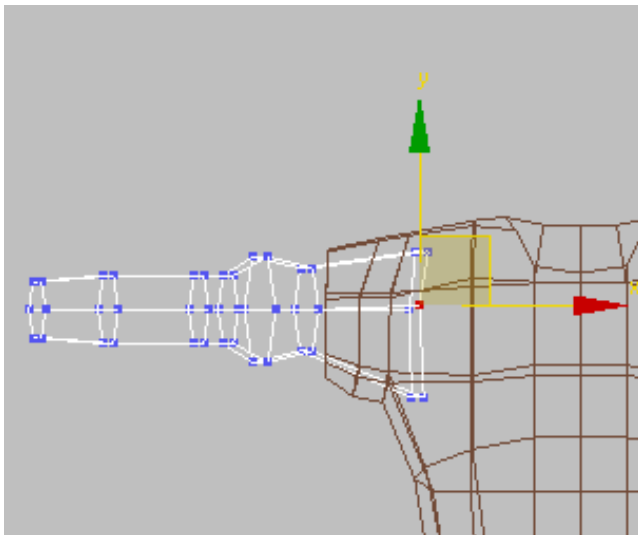

- 17 Press F3 again to return the viewport to shaded display.
- 18 Exit the sub-object level.

Create the hand:

- 1 Continue working on the same scene.
- 2 Zoom in on the hand sketch in the Top viewport.
- 3 Create a Box with the following parameters:

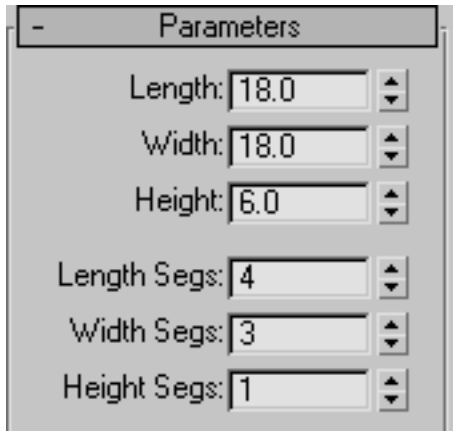

- 4 Use the Move tool to position the box properly in the Top and Front viewports.

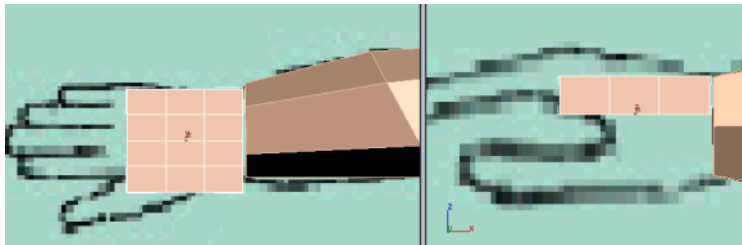

- 5 Convert the box to editable poly format.



- 6 Go to the Vertex sub-object level.

- 7 Region-select vertices in the Top viewport and move them to follow the shape of the back of the hand.

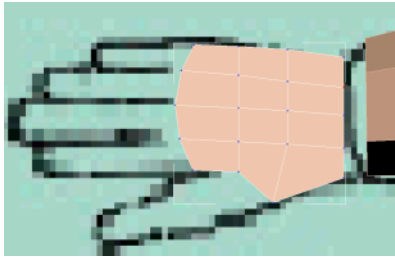

NOTE It is important to use region selection in the Top viewport to ensure you are selecting the top and the bottom vertices on a vertical edge.



- 8 Go to the Edge sub-object level.
- 9 In the Left viewport, select the three vertical edges separating the fingers.

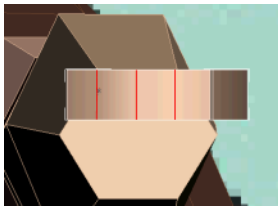

- 10 On the Edit Edges rollout, click the Chamfer Settings button.
This opens the Chamfer Edges dialog.
- 11 Set Chamfer Amount to **0.5** to separate the polygons that will be used to create the fingers. Click OK to exit the dialog.



- 12 On the Selection rollout, click Polygon.
- 13 In the Left viewport, select the polygon that represents the index finger.



- 14 On the Edit Polygons rollout, click the Bevel button.
- 15 Drag the selected polygon until you reach the first knuckle. Move the mouse downward slightly to scale down the selected polygon.



NOTE The Bevel tool acts like a combined extrusion/scale tool. Alternatively, you can use the Extrude command and then manually scale the selected polygon in a uniform or nonuniform way.

- 16 Create another extrusion/bevel for the knuckle.
The extra detail provided here ensures that the finger deforms properly when animated.
- 17 Continue beveling the finger all the way to the tip.

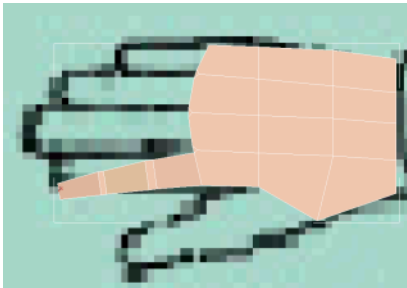

- 18 Repeat this procedure with the other fingers.
When you are done, the hand should look like the following illustration.

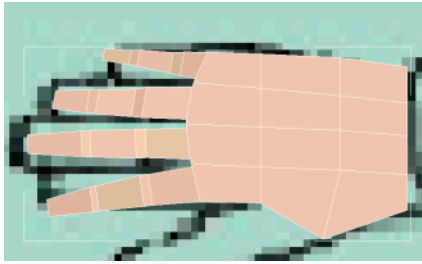

- 19 In the Perspective viewport, select the polygon representing the thumb.

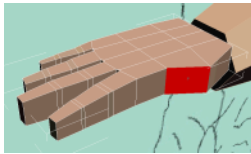

- 20 Use the Bevel tool to create the thumb, as you did earlier. This time, however, you'll need to use the Rotate tool with each extrusion to curve the thumb slightly.

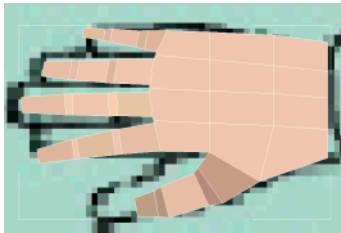

- 21 Go to the Vertex sub-object level.
- 22 Select all four of the vertices at the tip of the index finger.
- 23 Expand the Soft Selection rollout and turn on Use Soft Selection.
- 24 Turn on Edge Distance and set its value to 4.

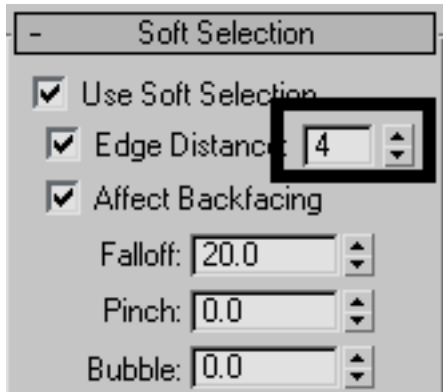

This ensures that soft selection does not extend beyond four edges and therefore will not affect the neighboring finger.

- 25 In the Front viewport, move and rotate the finger to give it a more relaxed look.

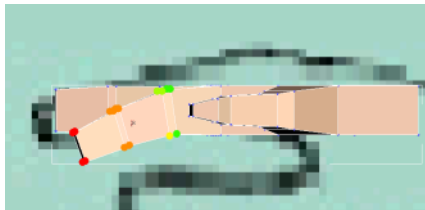

- 26 Adjust the other fingers as well. Use the Move, Rotate, and Scale tools to give the hand reasonable proportions.

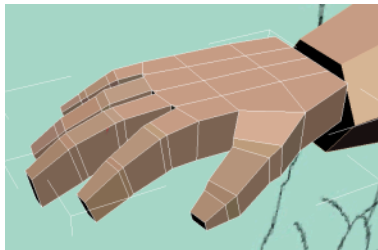

- 27 Adjust the vertices around the wrist to make that side more rounded. This will make it easier to connect the hand to the arm later.

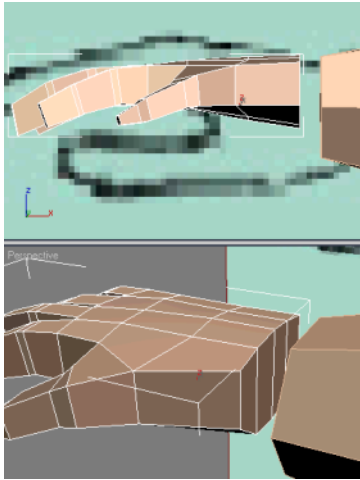

NOTE You might want to toggle Soft Selection mode on or off to round off the wrist to your liking.

28 Exit sub-object level when done.

Attach and bridge the objects:

- 1 Continue working from the previous lesson.
- 2 Select the Arm object.
- 3 On the Edit Geometry rollout, click the Attach button and then click the hand in any viewport to attach it to the arm.
- 4 Right-click to exit the Attach function.



- 5 Go to the Polygon sub-object level.
- 6 Select the polygons that face each other on the hand and arm.

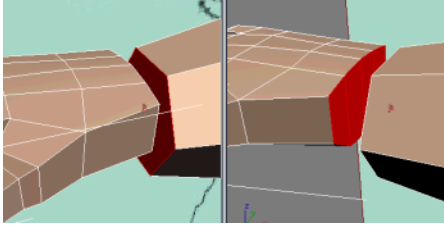

- 7 On the Edit Polygons rollout, click the small Settings button next to Bridge. A dialog appears.
- 8 The default settings should work fine but try out values for Twist and Segments to view the end results. Remember that changes will only be retained after you click OK.

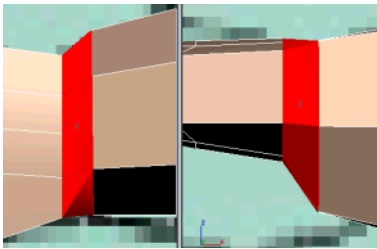

- 9 If necessary, go to Vertex sub-object level and fine-tune the area around the wrist.

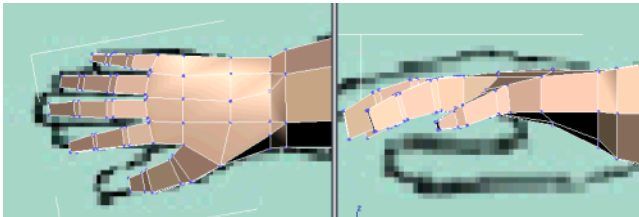

- 10 Exit sub-object level when done.
- 11 Rename the object **Arm_Right**.

Mirror and clone the arm:

- 1 Continue working on your scene from the previous exercise.
- 2 In the Front viewport, select the Arm_Right object.



- 3 On the main toolbar, click the Mirror button
- 4 Leave Mirror Axis set to X and set Clone Selection to Instance. Click OK to close the dialog.
- 5 Move the cloned arm in the Front or the Top viewport to reposition it properly.



- 6 Rename the clone **Arm_Left**.
- 7 Save your file as **My_Soldier_Arms.max**.

Next

[Modeling a Low-Poly Head](#) on page 295

Modeling a Low-Poly Head

This tutorial explains how to model a generic male head using box-modeling techniques combined with edge-modeling tips. While there are a number of ways to model a head, the process detailed here demonstrates core concepts applicable to any method, such as basic divisions, correct edge flow, and polycount optimization.

Even though this tutorial covers the entire head, you might decide to do only parts of the face, based on your needs. For example, if your character wears a hat and doesn't take it off, there is no need to model a full skull. In this case, parts of the head model will be used as a starting point to build the helmet.

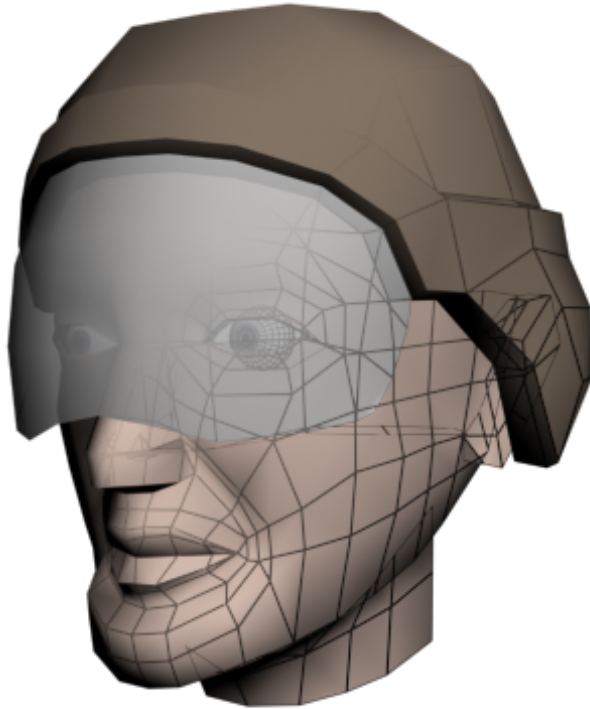

In this tutorial, you will learn how to:

- Sculpt organic shapes from a subdivided box.
- Use the Symmetry modifier to create a mirror duplicate of half of the model.
- Transform Editable Poly sub-objects for fine-tuning the model shape.
- Divide and connect edges together to add resolution where needed.
- Reposition edge loops to follow proper flow of facial muscles.

Skill level: Beginner

Time to complete: 45 minutes

Setting Up the Scene

Whether you are modeling an alien, a cartoon, or a realistic head, you must pay attention to the proportions of your reference material, as well as any details that highlight key features in your character's face.

For this tutorial, you will use two reference images that will guide you through this process, and also help you better understand the proportions that come into play when modeling a full head.

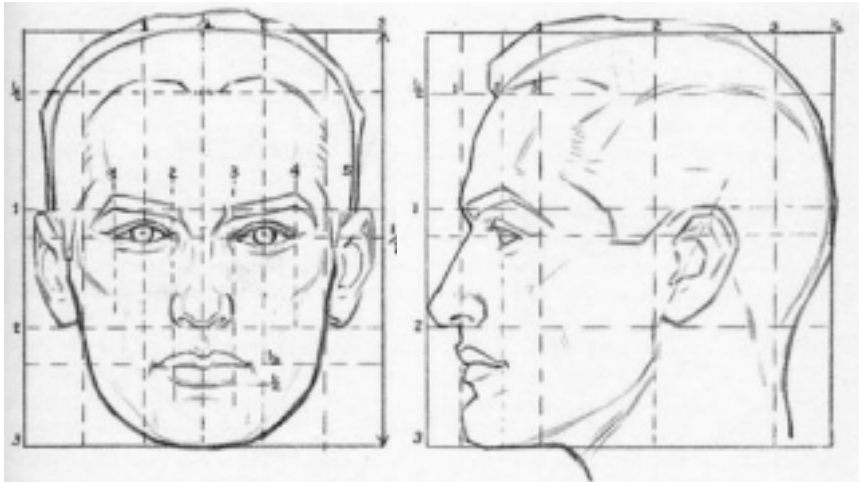

Creating a Virtual Studio

Before you begin, note the resolution (in pixels) of the reference images you've created. If you are using the files that have been provided for this tutorial, their resolutions are as follows:

Front reference image: **234 (width) x 274 (height)**.

Side reference image: **264 (w) x 274 (h)**.

Create the front reference plane:

- 1 Start 3ds Max.
- 2 From the Create menu, choose Standard Primitives > Plane.
- 3 In the Front viewport, click and drag an area of any size.

- 4  Go to the Modify panel. On the Parameters rollout, set Length to **274** and Width to **234**.
- 5 Set both Length Segs and Width Segs to **1**.

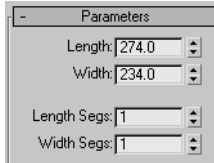

- 6  On the main toolbar, turn on Select And Move.
- 7 On the status bar, set the position values in X, Y, and Z to **0.0**.
This places the plane's pivot point at the world origin.

TIP One easy way to set a numeric field to 0.0 or its lowest possible value is to right-click its spinner.

Map a reference image:

- 1 Press M to open the Material Editor.
- 2 On the Blinn Basic Parameters rollout, set the Self-Illumination value to **100**.

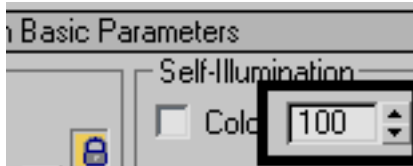

This lets you see the map without any help from scene lights.

- 3 Click the map button next to the Diffuse color swatch.
- 4 On the Material/Map Browser that appears, double-click Bitmap to choose this type of map.
This opens the Select Bitmap Image File dialog.
- 5 Browse to the `\sceneassets\images` folder and choose `Head_Front.jpg`. Click Open to close the dialog.

6  Click the Show Standard Map In Viewport button to toggle it on.

7  With the plane object still selected, click the Assign Material To Selection button to apply the newly created material to the plane.
You can now see the material on the plane in the Perspective viewport.

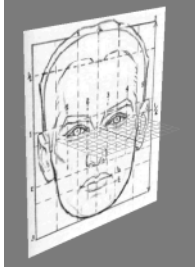

Create the side reference plane:

Now that you have created the front-view plane, you'll repeat the procedure to create an additional plane based on the side view.

1  On the Main toolbar, click Angle Snap Toggle to turn it on.
This lets you rotate your objects with precision using static increments.

2  Turn on Select And Rotate, then hold down the Shift key, and in the Perspective viewport rotate the plane 90 degrees about the Z axis (the horizontal ring of the rotate gizmo). The Clone Options dialog appears when you release the mouse. Make sure Copy is chosen, then click OK.

3  Go to the Modify panel. On the Parameters rollout, change the Width to **264**.

4 Use the steps you followed in the previous procedure to map *Head_Side.jpg* to the new plane. Remember to use a new sample slot in the Material Editor. When you are done, the Perspective viewport should look like this:

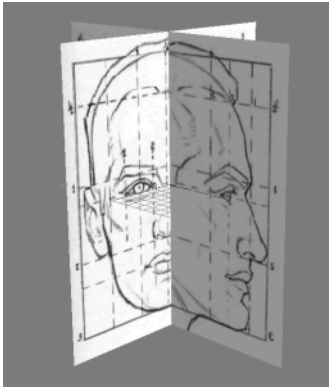

Adjust the virtual studio:

Before you can start modeling the character, you need to adjust the positions of the reference planes.

- 1 Activate each viewport in succession and press G to toggle off the grid. Currently, only the Perspective viewport is shaded.
- 2 Make sure every viewport is shaded by first activating it and then pressing the F3 keyboard shortcut.



- 3 Select the side reference plane and move it on the X axis (red axis) to the left edge of the virtual studio.

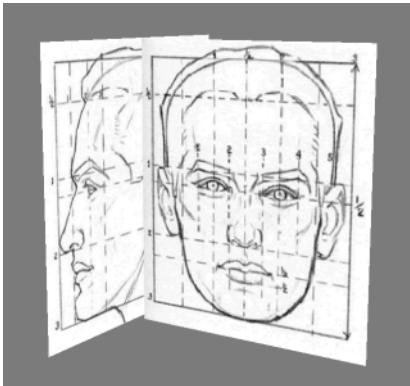

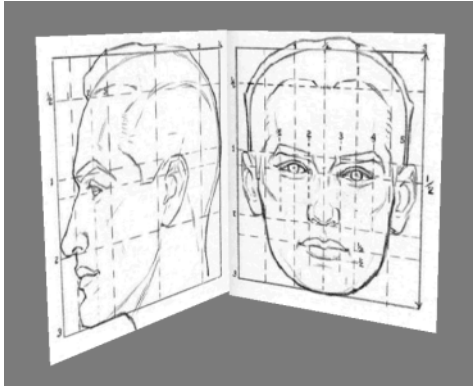

- 4  Select the front reference plane and move it on the Y axis to the back edge of the virtual studio.



- 5 Finally, click the Left viewport's Point Of View (POV) viewport label and choose Right from the menu.
This swaps views for a better profile view of the face.

Freeze the reference planes:

Now that the reference planes are in place, you'll freeze them to prevent accidentally moving them.

- 1   Select the two reference planes, then go to the Display panel.
- 2 On the Display Properties rollout, turn off Show Frozen in Gray.

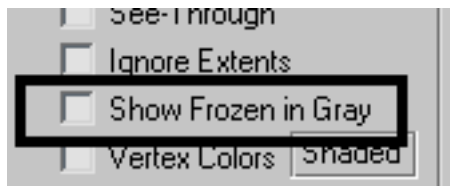

NOTE Leaving this option on would turn the planes dark gray after freezing them, preventing you from seeing the reference images. In the case of a virtual studio, you want to disable this option.

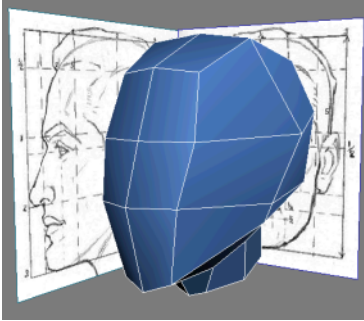

- 3 Expand the Freeze rollout and click Freeze Selected.
- 4 Save your file as **My_Virtual_Studio_Head.max**.

Creating the Basic Head Divisions



In this lesson, you start shaping the rough volume of the head from a simple box primitive. The goal is to shape your initial object as much as you can to match the basic proportions of the reference planes; this will help later on when you add details to the mass.

Align a box primitive with the reference planes:

- 1  Continue working on your file from the previous exercise, or on the Quick Access toolbar, click the Open File button, navigate to the file *virtual_studio_head.max* and open it.
- 2 In the Perspective viewport, create a primitive box.
- 3  Turn on the Move tool. Then, on the status bar, set the position values in X, Y, and Z to **0.0**.

This aligns the box's pivot point to the origin of world coordinates.

TIP You can set any numeric field to 0.0 or its lowest possible value by right-clicking its spinner.

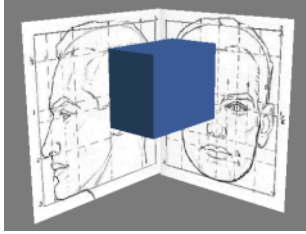

The box's pivot point is centered on all three axes.

- 4  Go to the Display panel and expand the Display Properties rollout if necessary. Then turn on See-Through to make your mesh semi-transparent in the viewports.

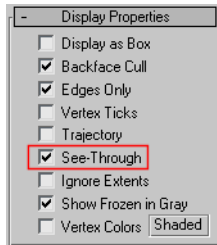

You can now follow the reference images as guides while modeling.

TIP Use the shortcut Alt+X to toggle See-Through mode.

- 5  On the Modify panel, change the Length, Width, and Height values on the Parameters rollout so the box covers most of the neck and skull. You can use the outer grid from the reference images to guide you.

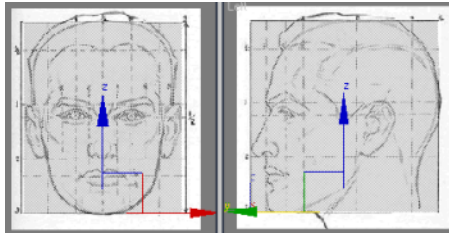

Adjust your box so it covers most of the head and neck.

- 6 Set the Length Segs to **2**, the Width Segs to **2**, and the Height Segs to **3**.
- 7 Rename the box **Low-Poly Head**.
- 8 Right-click *Low-Poly Head* and choose Convert to > Convert To Editable Poly from the quad menu.

NOTE You could also choose to convert your model to an *editable mesh* and get similar results. An *editable mesh* uses only triangular polygons, while an *editable poly* can be composed of polygons with more than three sides. In an *editable mesh* object, a square polygon (composed of two triangular faces) contains an invisible edge, also known as a *diagonal*.

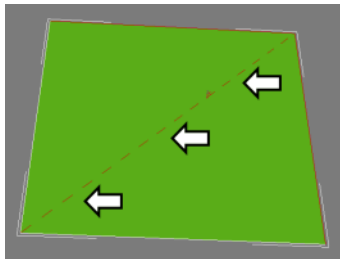

Both object types have their respective modeling tools and settings. They are meant to be complementary to one another. However, in this tutorial, *editable polys* are preferred because we mainly deal with quadrangular polygons, which are better suited for good edge flow.

Add a symmetry modifier:

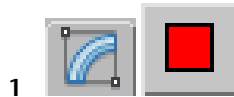

- 1 On the Modify panel, click the Polygon button to turn it on.

You are now at the Polygon sub-object level.



- 2 In the Front viewport, select all faces on the inner side of *Low-Poly Head*.

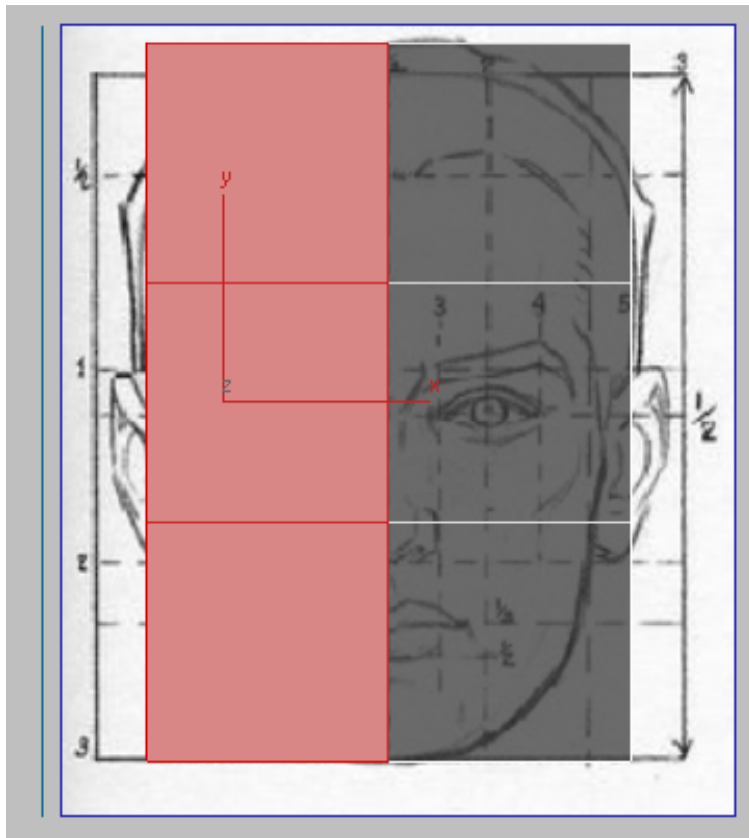

- 3 Press Delete to remove the selected faces.



- 4 Click Editable Poly in the Modifier Stack to exit the sub-object level. Then choose Symmetry from the Modifier list.

TIP You can also apply a modifier to a sub-object selection if you want it to affect only certain parts of your object.

- 5 On the Parameters rollout, make sure the X axis is chosen. Any further changes will be mirrored along this axis.

Shape the head and extrude the neck:

- 1  Highlight Editable Poly in the Modifier stack. Turn on the Show End Result On/Off Toggle to display both sides of *Low-Poly Head* while you're modeling.

- 2   Go to the Vertex sub-object level. In the Right viewport, move mesh vertices so the outline of the head matches the reference image.

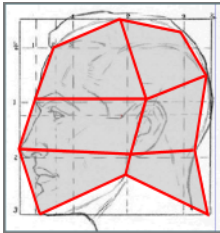

TIP  To make sure you select all overlapping vertices, drag a region around the desired vertices; this will select every vertex within this region. See *Rectangle Selection Region*.

The positioning of the vertices following the reference image is mainly based on the face's key features, such as the top of the ear and where the forehead meets the hairline. Even though these are only the first steps in this modeling exercise, providing good anchor points to start from can guide you later on when things get more complex.

- 3 Select the two vertices sticking out in the neck and click Edit Vertices rollout > Remove.

While pressing Delete deletes the sub-object selection as well as any immediate sub-objects (such as edges and polygons), Remove eliminates only the sub-object selection and then combines the polygons that use them.

TIP You can also use the shortcut Backspace to remove a vertex.

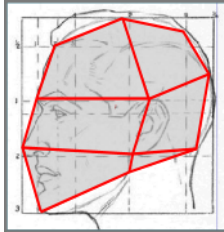

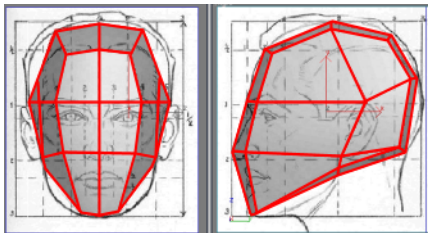

- 4 Continue adjusting vertices in both the Front and Side viewports to better define the volume of the head.

TIP Use the shortcut Alt+W to quickly switch from single-view to quad-view, where you can see multiple viewports.



- 5  On the Display Properties rollout of the Display panel, turn off See-Through mode.

- 6   In the Front viewport, Orbit and Pan so you can see the single vertex located where the neck starts.

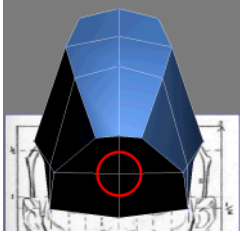

- 7 Go to the Modify panel and turn on Vertex sub-object selection once again.



- 8 Select the vertex at the base of the head.



- 9 On the Edit Vertices rollout, click the Chamfer Settings button. In the Chamfer Vertices dialog, set Chamfer Amount to **50** and turn on Open. Click OK.

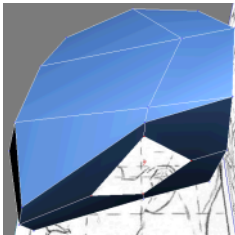

3ds Max chamfers the vertex, creating a hole for the neck. The vertices that surround the new chamfer are still selected.





- 10 While the resulting vertices are selected, hold down the Shift key and click the Edge button on the Selection rollout to convert your sub-object selection to a selection of border edges.

- 11 On the Edit Edges rollout, turn on Extrude.

- 12 In the Perspective viewport, hold down the Shift key and drag the edges upward to create a neck extrusion. Watch the Right viewport to see how long the neck should be.

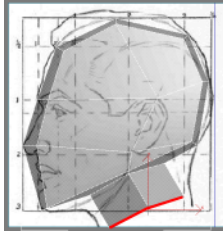

TIP Toggle See-Through mode to help you match the edges to the reference image.

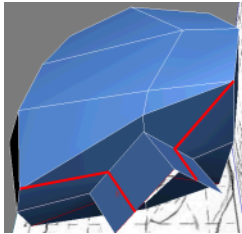

- 13  Orbit a viewport so you can see the bottom of the head and the sides of the neck.
- 14 On the Edit Geometry rollout, turn on Cut to enable the Cut tool. Use it to create two sets of new edges down the neck: one starting from the face and the other from the back of the head.
- The neck now has the same amount of faces as the head. Click Cut once more or right-click in the active viewport to exit the Cut tool.



- 15 Press Shift+Z to undo the view changes.

- 16   Go back to the Vertex sub-object level and move vertices to make neck more round.

TIP To quickly move between the different sub-object levels, you can use the shortcut keys 1,2,3, and 4.

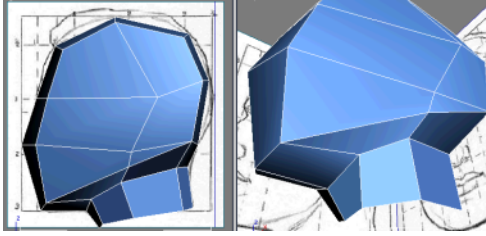

TIP Use a Top or Bottom viewport to help you place the vertices.

17 Save your file as **My_Low_Poly_Head_Basic_Divisions.max**

Creating the Nose

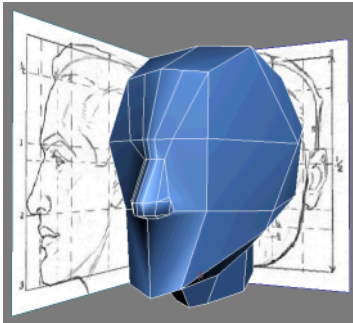

In this lesson, you start adding new divisions in the center of your mesh to shape up the nose and nostrils. As the central element in a character's face, it's important to properly establish the nose's proper edge flow that will eventually link to the forehead, eyes, and mouth.

Whenever possible, try to always use quads (four-sided polygons) and avoid polygons that have five or more sides. Maintaining quad topology results in cleaner geometry, as opposed to polygons of five or more sides, which produce unpredictable results when the time comes to subdivide, texture, or skin your model.

Define the nose:

- 1  Continue working on your file from the previous exercise, or load the file *Low_Poly_Head01.max* found under `\modeling\low_polygon_modeling`

- 2  Go to Edge sub-object level and, in the Front viewport, select the horizontal edges at the eyebrow and nose levels.

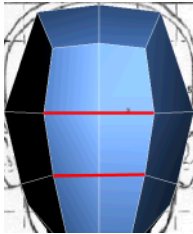

- 3  On the Edit Edges rollout, click the Connect Settings button. In the Connect Edges dialog, set Segments to **2**.
- 4 Use the Pinch spinner to move the new edges closer and the Slide spinner to center them on the nose. Click OK.



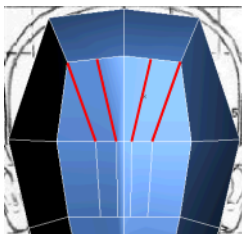

- 5 On the Edit Geometry rollout, turn on Cut and create two new divisions from the current nose edges across the forehead. These will be useful later on.

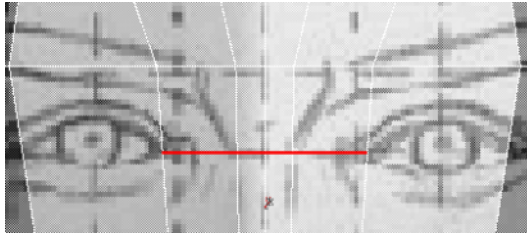

- 6  Select the three vertical edges that currently define the nose, and then click the Connect Settings button.
- 7 On the Connect Edges dialog, right-click both the Segments and Pinch spinners to reset their values. Use the Slide spinner to align the new edge to the nasal bone and tear duct (the inner corner of the eye where both eyelids meet) in the Front viewport's reference image. Click OK.



- 8   Go to the Vertex sub-object level and move the new vertices in both Front and Side viewports to roughly follow the nose shape.

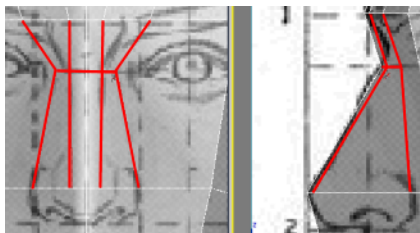

- 9 Turn on Cut and in the Right viewport, create new edges around the current edge at the nose tip level. These new edges must be connected through the outer nostril vertex.



- 10 In the Front viewport, use Cut to add an edge under the nose tip for the nasal septum.

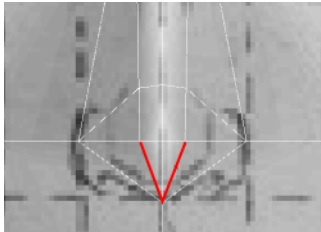

- 11 Reposition the resulting vertices to better define the nose tip and nostril sidewalls.

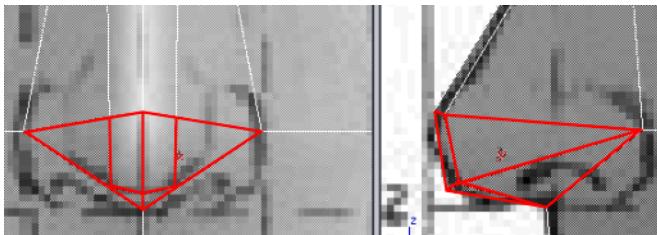

Define the outer nostrils:



- 1 Go to the Edge sub-object level and select the three edges that roughly define the outer nostril.

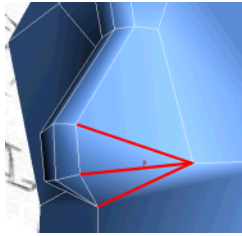

- 2  Click the Connect Settings button. In the Connect Edges dialog, set Segments to **2** and Slide to **0**, and leave Pinch at **0**. Click OK.

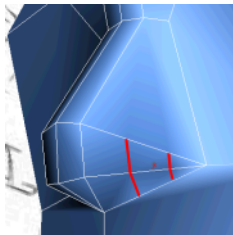

- 3  Go to the Vertex sub-object level and click Target Weld on the Edit Vertices rollout to enable the Weld tool.
- 4 Click one of the middle vertices on the nostril's lower edge, and then move your cursor towards the other middle vertex.
Notice the dotted line from the selected vertex, which indicates the welding order.



- 5 Click the other middle vertex.
This welds both vertices together.



- 6 Exit the Weld tool by clicking Target Weld once more or right-clicking the active viewport.



- 7 Adjust the new vertices to match the volume of the outer nostrils.



- 8 In the Right viewport, select the vertex on the side of the nose bridge as well as the one below it, that shapes the outer nostril.

- 9 On the Edit Vertices rollout, click Connect.

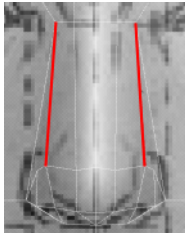

- 10 Go to the Edge sub-object level and then click Insert Vertex on the Edit Edges rollout.

- 11 Locate the vertical edge that separates the nose from the cheek area. Click the edge where you want to insert a vertex.

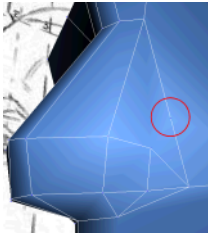

- 12 Go back to the Vertex sub-object level and connect the three neighboring vertices that define the outer nostril.

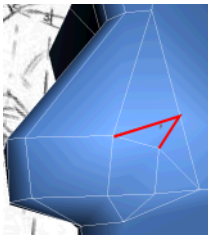

- 13 Adjust the vertices to match the reference planes.

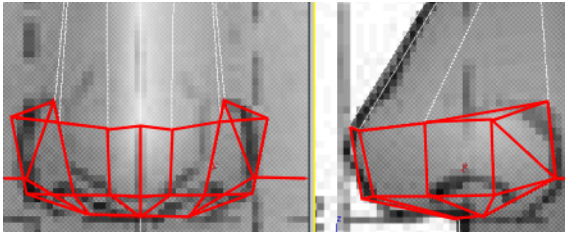

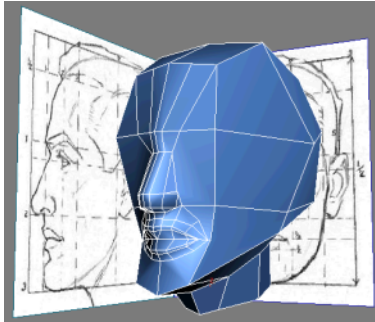

- 14 Save your file as **My_Low_Poly_Head_Nose.max**

Creating the Mouth



In this lesson, you get a first taste of creating concentric edge loops to form the mouth. These loops are put in place to mimic the orbicularis oris muscles underneath the skin; these muscles are crucial to everything from smiling to whistling to yawning. Therefore, you must ensure that the facial geometry deforms accurately or it will not only negatively impact your facial expressions, but also affect how your character's skin texture will stretch out to follow the geometry.

Define the lips:

- 1  Continue working on your file from the previous exercise, or load the file *Low_Poly_Head02.max* found under `\modeling\low_polygon_modeling`.
- 2   Go into Edge sub-object level and select the vertical edges in the lower part of the face.

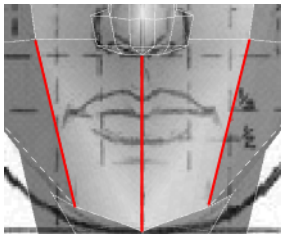



3 Click the Connect Settings button. On the Connect Edges dialog, reset the Segments, Pinch, and Slide values, and then click OK.

4 On the Edit Geometry rollout, choose Edge in the Constraints group.

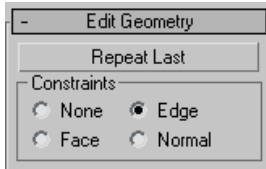

5 Move the new edge to where the upper and lower lips meet. Notice how the constraint forces it to translate along the vertical edges.

TIP Learn to use the different Constraints settings to accelerate your workflow.

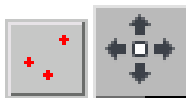

6 Go to the Vertex sub-object level and move the vertex at the right end of the new edge so the edge is level with the mouth.

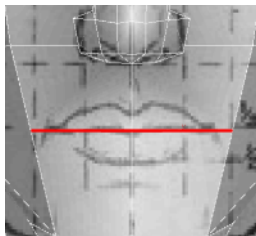

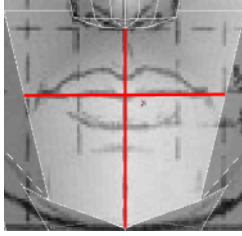

7 Go back to the Edge sub-object level. Select the new edge, as well as both halves of the edge that runs from the nose to the chin.

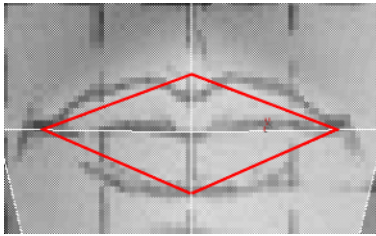

- 8  Click the Connect Settings button. On the Connect Edges dialog, use the Slide spinner to move the new edges until they stretch out to the lip extremities. Click OK.



- 9   Go to the Vertex sub-object level. On the Edit Geometry rollout, notice how the Constraints drop-down setting persists at sub-object levels (in this case, Edge). Adjust the vertices to match the lip contours.

- 10  In the Constraints group, choose None, and then in the Right viewport, adjust the new vertices to better define the lips as shown in the reference image. You might have to make room and move back some vertices in the cheek area.

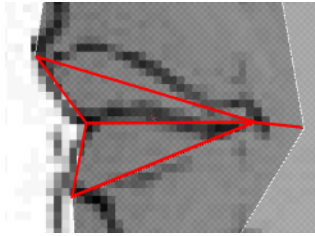

11 Use Cut to create two edges surrounding both lips.

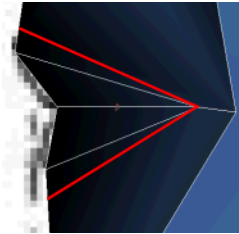

12 Reposition the new vertices to emphasize the lip borders.

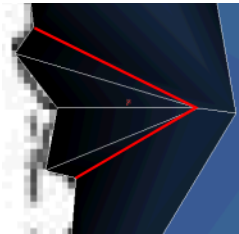

Define the edge loops around the mouth:



- 1 Go to the Edge sub-object level and select the following edges:
 - The edge over the philtrum (the vertical groove between the nose and upper lip)
 - The edge under the lower lip
 - The horizontal edge starting at the corner of the mouth

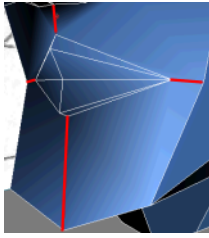

- 2 On the Edit Edges rollout, click Connect to link them together.

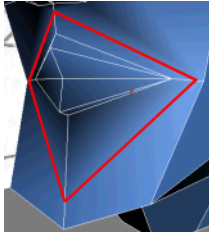

- 3 Select the three edges that define the upper lip.

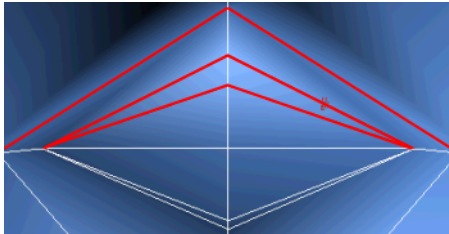

- 4  Click the Connect Settings button. On the Connect Edges dialog, set Segments to **3** and leave both Pinch and Slide at their default value of 0.0. Click OK.

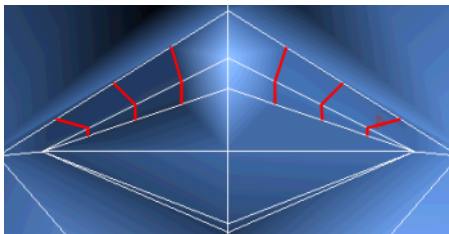



- 5 Go to the Vertex sub-object level, then adjust the new vertices to roughly match the volume of the upper lip.

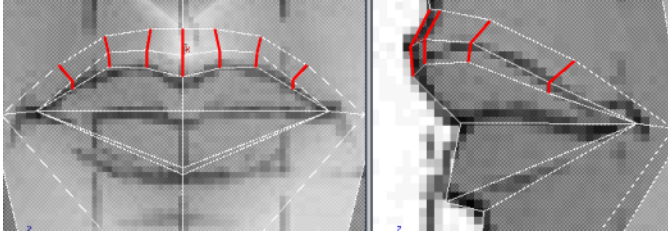

- 6 Repeat the last three steps for the lower lip. This time, though, use only two new connecting edges. Toggle Edge Constraints to help you along.

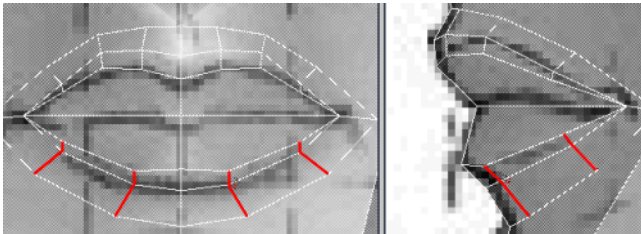

- 7 Click Cut and draw edges across the lips, starting from the corner of the mouth going in. As the lips do not share the same amount of connectable vertices, link the last upper lip vertex to the center vertex.

These cuts help maintain the quad topology of the face, which comes into play during facial animation and speech.

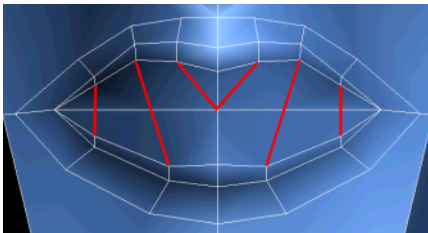

Connect the mouth to the nose;



- 1 Select the vertex at the corner of the mouth, then the vertex at the lower corner of the nostril. On the Edit Edges rollout, click Connect to link them.

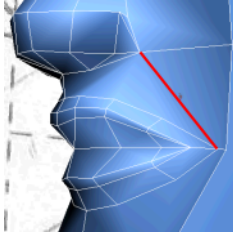

- 2 Repeat the same step to connect the nostril vertices to corresponding upper lip vertices. Note that you will need the Cut tool to connect one lip vertex to the edge above it.

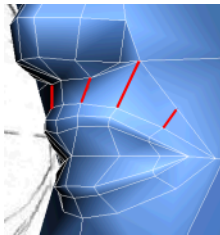

- 3 Adjust the new vertices to maintain a smooth circular flow between edges.
- 4 Save your file as **My_Low_Poly_Head_Mouth.max**

Taking it Further: Creating The Inside of The Mouth

Use the tools and techniques learned in this lesson to create the inside of the mouth. For example, you could use the Connect tool to create a new edge loop, and then use the Bevel or Extrude tools to push the resulting polygons inside the mouth.

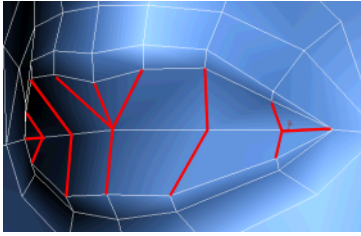

Select the lip edges to connect.

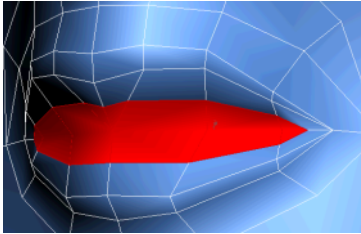

Connecting these edges gives you a new set of polygons.

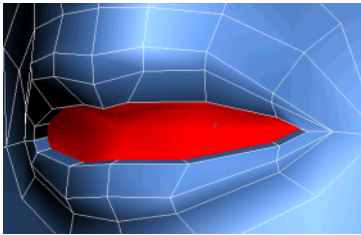

Push the new polygons inside the mouth.

Creating the Eyes

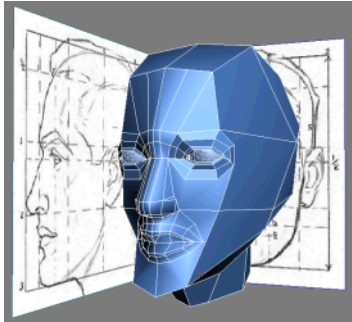

In this lesson, your character will see the world through the eyes you sculpt. You must first carve the area containing the eye socket and orbicularis oculi muscles, responsible for closing the eyelids and lowering the brows. Then, you progressively shape concentric edge loops to match the eyelids and insert some eyeballs.

Define the eye muscles:

- 1  Continue working on your file from the previous exercise, or load the file *Low_Poly_Head03.max* found under `\modeling\low_polygon_modeling`.

- 2  Go to the Vertex sub-object level, then turn on Cut and create an horizontal division across the eyes starting from the nose bridge.

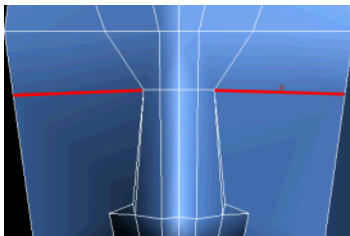

- 3 Using Cut again, create three continuing edges from the same point of origin. These edges roughly limit the extents of the eye muscles.

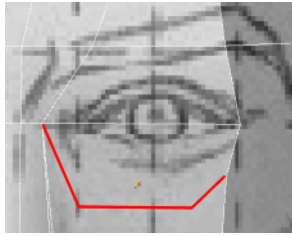

- 4 Divide the nose root in two to better define the procerus muscles.

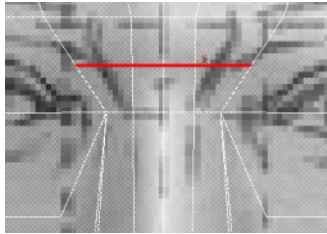

- 5 Adjust the vertices around the eyes to encompass part of the brows.

This is a starting point in delimiting the eyes from the rest of the face. Once they are completed, you will integrate them to the other elements.



- 6 Go to the Edge sub-object level, and then select the first edge you created that runs across the eyes.

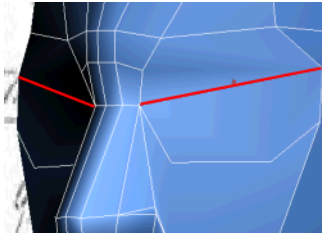

7 On the Edit Edges rollout, click Remove.

Define the eyelids:

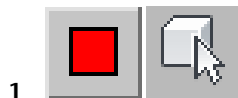

1 Go to the Polygon sub-object level, and then select the polygon covering the eye surface.

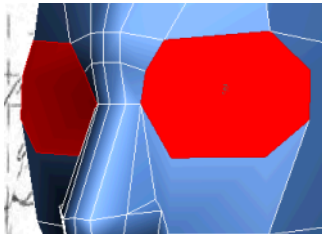

2 On the Edit Polygons rollout, click the Inset Settings button. In the Inset Polygons dialog, set Inset Amount to 5. Click OK.

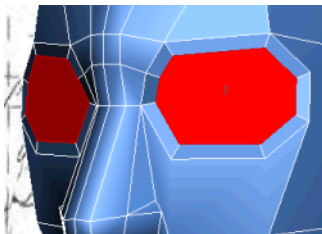

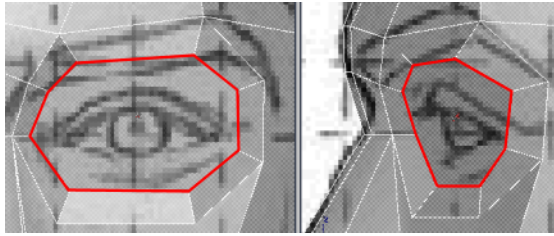

3 Go to the Vertex sub-object level and adjust the new vertices to roughly match the reference images.



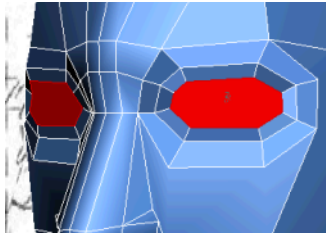

- 4  Go back to the Polygon sub-object level, and then on the Edit Geometry rollout, click Repeat Last. Another concentric edge loop is created.

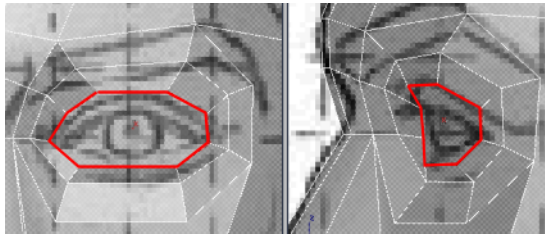

- 5   Go to the Vertex sub-object level and adjust the vertices so they border the eyelids.



- 6   Go to the Polygon sub-object level. The eye polygon should be automatically selected (if not, select it). Click the Bevel Settings button.

- 7 In the Bevel Polygons dialog, set Height to **-1.5** and Outline Amount to **-2**. Click OK.

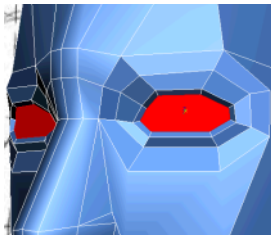

- 8 Press the Delete key to remove the eye polygon. You will soon replace it with the actual eyeball.

Insert the eyeballs and refine the upper eyelids:

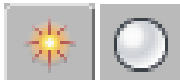

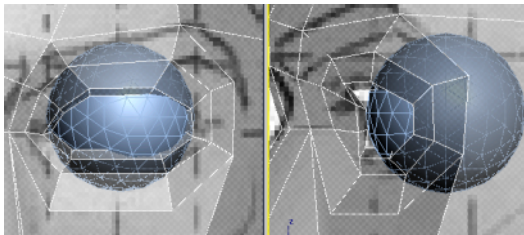

- 1 Create a primitive geosphere and place it following the reference images. Adjust its size approximately.

TIP A geosphere has fewer polygons than a standard sphere, making it an useful alternative if you need to optimize your polygon count.

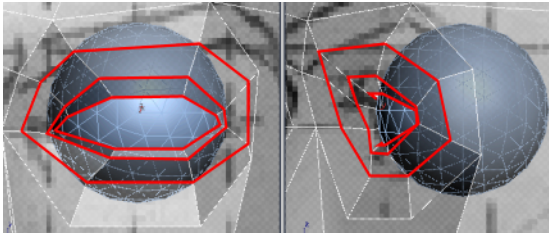

- 2 Adjust the vertices around the eyeball so they surround it without touching. For a natural look, the eyelids should be bordering the eye's iris and pupil.



- 3   Go to the Edge sub-object level and select five ring edges shaping the upper eyelids.

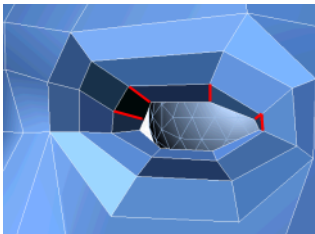

- 4 Use the Connect tool to join them together.

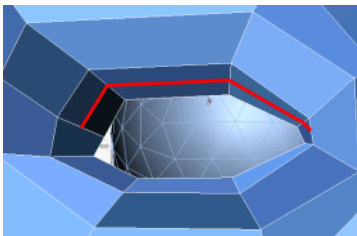

- 5 Use the Cut tool to link the new upper eyelid edges to nearby vertices.

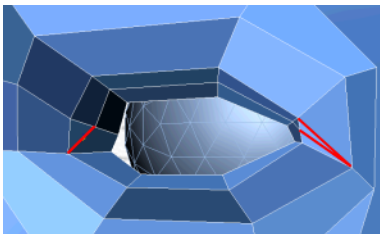

- 6 Drag these new edges forward to build some volume in the upper eyelids.

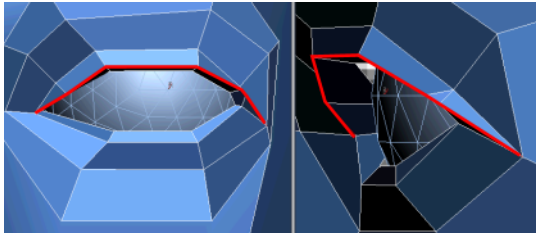

- 7 Go to the Vertex sub-object level and then, to better tuck the lower eyelids under the upper eyelids, use the Target Weld tool to merge two vertices together. This will also eliminate a five-sided polygon.

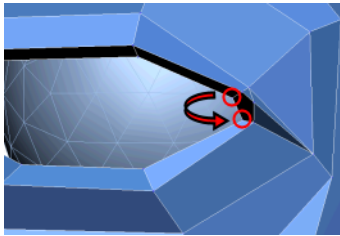

- 8 Exit the Vertex sub-object level and select the eyeball itself. Copy its position on the X axis.

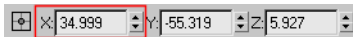

- 9 Hold down the Shift key and drag the eyeball to the other socket. This creates a duplicate of the object.
- 10 Paste the original eyeball's X position onto the X field of the duplicated eyeball. You must enter the value as negative because the new eyeball is on the other side of the central axis.
- 11 Save your file as **My_Low_Poly_Head_Eyes.max**

Refining the Forehead, Chin, and Cheeks

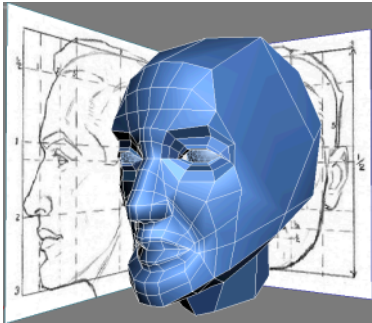



This lesson unfolds into three sections. You first add more details to the forehead, then the chin, and finally the cheeks. You'll orient the edge loops progressively to interconnect these regions.

Remember the importance of keeping your geometry uniformly spaced to prevent stretching in later stages of production such as UV texturing and skinning.

Refine the forehead:

- 1  Continue working on your file from the previous exercise, or load the file *Low_Poly_Head04.max* found under *\modeling\low_polygon_modeling*.

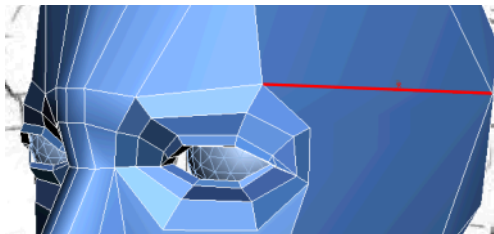

- 2   Go to the Edge sub-object level, then select the edge linking the eye muscles to the temporal bone on the side of the head.

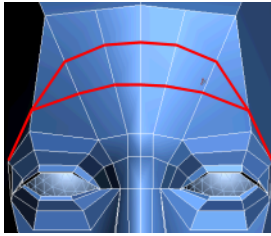

- 3 On the Edit Edges rollout, click Remove to delete the edge.

- 4 Turn on Cut, and in the Front viewport, draw a series of edges to define the forehead.



- 5   Go to the Vertex sub-object level and adjust the new vertices in both the Front and Right viewports to match the forehead as well as the skull volume underneath.

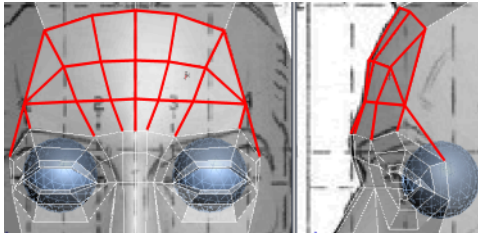

Refine the chin:

- 1  Select the cheek vertex as well as the one shaping the top of the nostril. On the Edit Vertices rollout, click Connect.

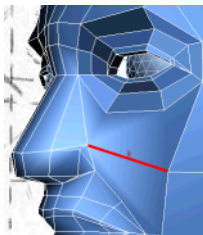

- 2 Click Target Weld and select the cheek vertex. Then, move your cursor towards the one below it.

Notice the dotted line linking the selected vertex to your cursor.

- 3 Click the vertex below the one you previously selected to complete the welding operation.

This starts the mouth crease, which is crucial to portray emotions.

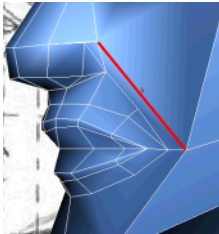

- 4 Click Target Weld once more or right-click in the active viewport to exit the Weld tool.
- 5 Click Cut and connect the mouth crease edge to the vertical chin edge.

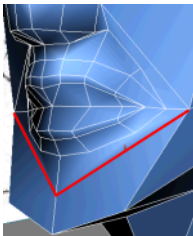

- 6 Following the same technique, link the outer mouth edge loop to the mouth crease edge loop through the remaining vertices.

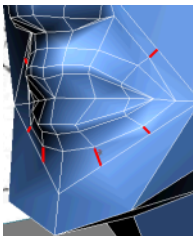

- 7  Adjust the vertices to match the circular edge flow originating from the mouth.

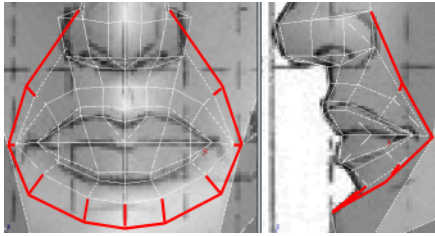

- 8 On the Edit Geometry rollout, choose Edge in the Constraints group.



- 9 In the Right viewport, pull back the vertex currently in the chin area until it follows the curvature of the mouth crease. You need to translate the vertex on both the X and Y axes using the Move transform gizmo.



- 10 Choose None in the Constraints group.
- 11 Use the Cut tool to connect that same vertex to the edge under the chin. This completes another edge loop.

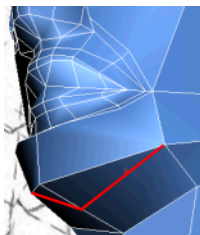

- 12 Go to the Edge sub-object level and select the vertical edges linking the lower lip to the chin.

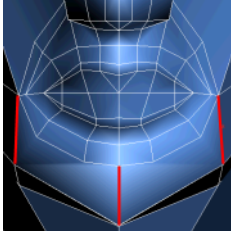

- 13 Click Connect to create a joining edge between them.

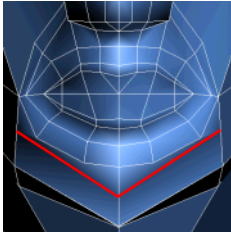

- 14 In the Right viewport, select the four edges defining the chin and throat.

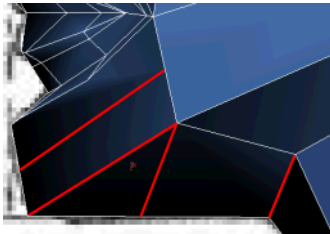

- 15 On the Edit Edges rollout, click the Connect Settings button. In the Connect Edges dialog, set Segments to **2**. Click OK.

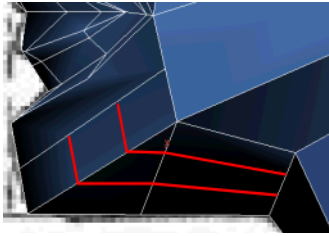

- 16**  Go back to the Vertex sub-object level, and using either the Cut or Connect tool, connect the vertices between the mouth's lower edge loop and the chin's upper edges.

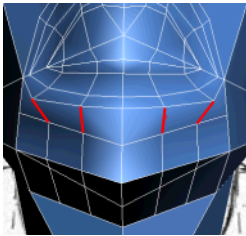

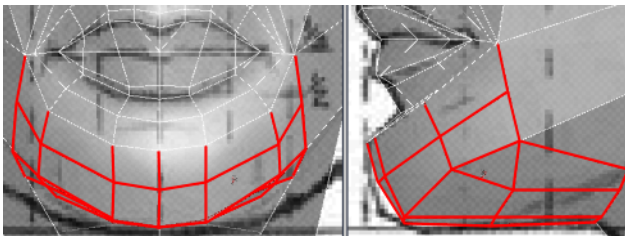

- 17** Adjust the new vertices to round up the chin while maintaining the circular edge loops.



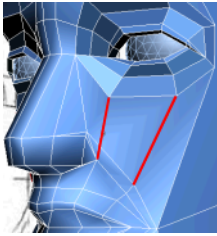

Refine the cheeks:

- 1** Click Cut and draw new edges to link the vertices from the mouth crease to the eye's lower edge loop.



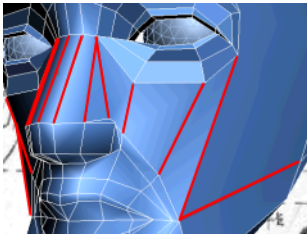

- 2  Go to the Edge sub-object level and select the edges covering the nose and cheeks. Although they are not parallel, they are running in the same direction.

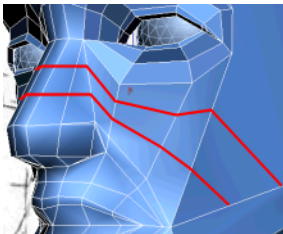

- 3  Click the Connect Settings button. In the Connect Edges dialog, set Segments to **2**. Click OK.
Do not worry if the resulting edges do not run smoothly across the face.



- 4   Go to the Vertex sub-object level and move the resulting vertices to recreate the bump in the nose, build up some volume in the cheeks, and emphasize the mouth crease.

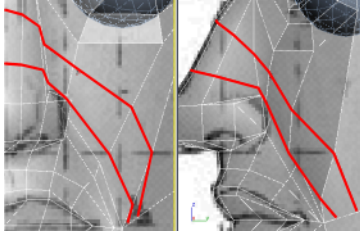

- 5 Use either the Cut or Connect tool to complete the edge loops by linking the remaining vertices together.

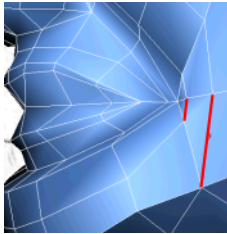

- 6 Make a cut to divide the outer cheek's polygon in half. The cheek's last edge loop originates at the corner of the eye and ends at the jaw line.

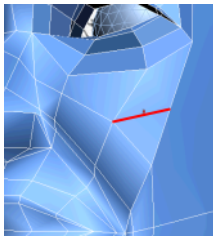

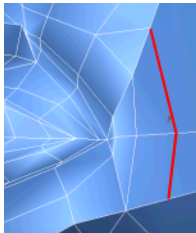

- 7 Draw two new edges to link the last cut to the jaw line.

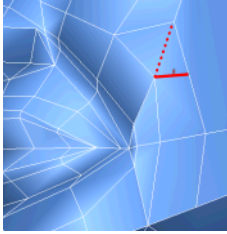

- 8  Go to the Edge sub-object level and Remove the obsolete edge. Then replace it with a new one to connect to the cut from the previous step.



- 9   Go back to the Vertex sub-object level and adjust the resulting vertices to define the zygomatic bone.

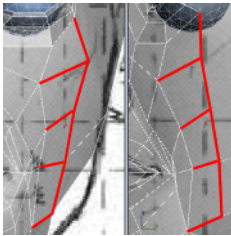

Reconstruct the mouth corner:

Now that you have established the major edge loops around the mouth and cheeks, you will go back and change some edges to clean up the mouth crease's edge loops.

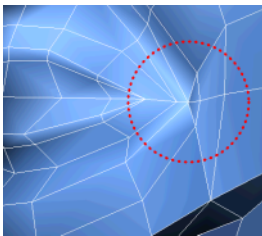

- 1 Click Cut and make a straight cut from the corner of the mouth to the mouth crease's outer edge loop.



- 2 Click Target Weld and merge two vertices located near the lips.



- 3  Adjust the respective vertices to align the edges so they match the other neighboring loops.

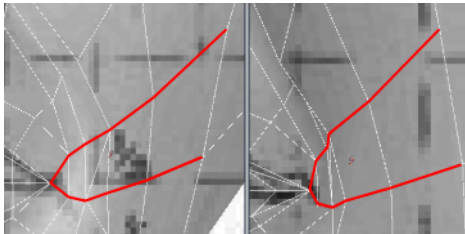

- 4  Select the diagonal edge and click Remove on the Edit Edges rollout.

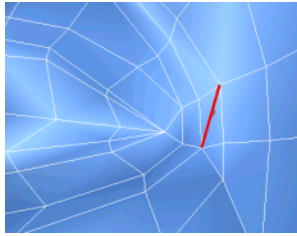

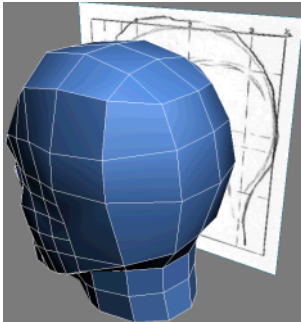

- 5 Save your file as **My_Low_Poly_Head_Forehead_Chin_Cheeks.max**

Refining the Head and Neck



In this lesson, you progressively expand the face's edge loops toward the back of the head, and then refine the neck. You can always come back afterwards and add a hairline to give your character more personality.

Refine the head volume:

- 1  Continue working on your file from the previous exercise, or load the file *Low_Poly_Head05.max* found under *\modeling\low_polygon_modeling*.
- 2  Go to the Vertex sub-object level, and then on the Edit Geometry rollout, turn on Cut and extend the cheek, eye, and forehead edges to the side of the head.

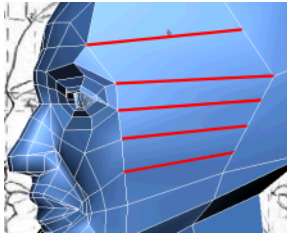

- 3 Use the Cut tool again to divide the resulting edges in two. Connect the new edges to the current forehead edge loop and jaw line.

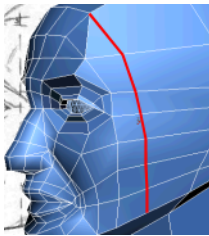

- 4  Go to the Edge sub-object level, and then select the forehead edge that does not match the face's circular edge flow.

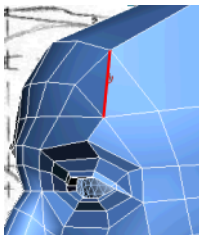

- 5 On the Edit Edges rollout, click Remove.

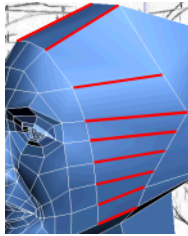

- 6  Select all the ring edges in the temporal bone region (between the eye socket and the ear). Do not select edges below the jaw line. Include the edge at the top of the skull.

TIP To quickly select multiple ring edges, select one edge and then click Ring on the Selection rollout. You might have to Ctrl+select the edge at the top of the skull to add it to the ring.

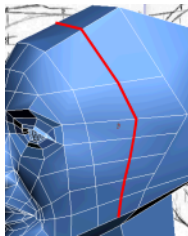

- 7  Click the Connect Settings button. In the Connect Edges dialog, make sure Segments is set to 1 and Pinch and Side both set to 1.0. Click OK.



- 8   Go to the Vertex sub-object level and reposition the new vertices to match the width of the head in the reference images.

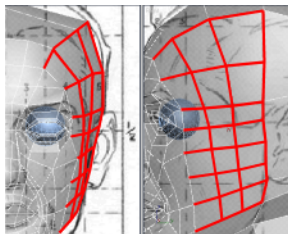

- 9 Turn on Cut and draw a series of continuous edges all around the head to connect the forehead's frontalis muscles to the occipitalis muscles, located at the base of the skull.

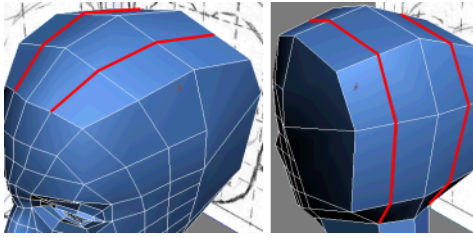

To do this, you might have to Orbit the view and then turn on Cut once more. When you are done, you can press Shift+Z to undo view changes.

- 10 Use Cut to create another series of horizontal edges at the back of the head, covering the parietal bones.

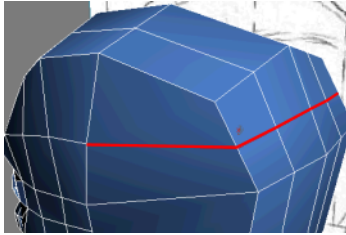

- 11 Go to the Edge sub-object level. In the Edit Geometry rollout L Constraints group, choose Face.



- 12 Select the three edges from the outside row of the back of the head and move them along the Y axis toward the ears. The Face constraint helps retain the skull volume.

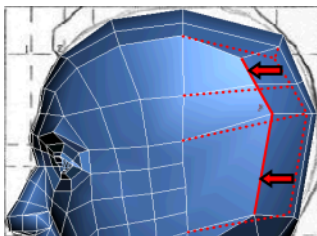

- 13 In the Constraints group, choose None.
- 14 Use Cut to connect the offset edges to the top of the head.

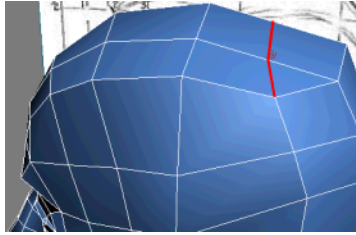

- 15  Turn off Cut. Go to the Vertex sub-object level and adjust the vertices to refine the head's volume and retain an uniform spacing between polygons.

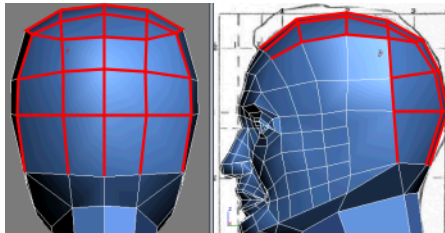

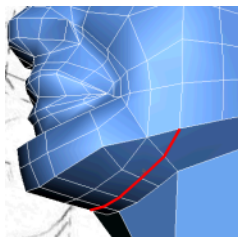

Refine the neck:

- 1 Turn on Cut and divide the polygons in the throat area to complete the last edge loop bordering the eyes.

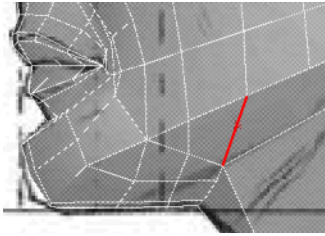

- 2 Make a new cut to connect the throat's lower edge loop to the side of the head.



- 3  Turn off Cut. Go to the Vertex sub-object level, and then reposition the throat's vertices to match the reference images.

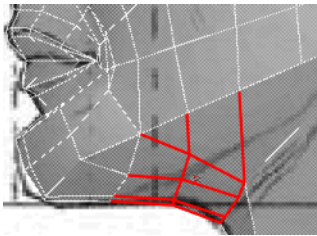

- 4 Turn on Target Weld and merge the four vertices at the base of the neck into two common gathering points. (You need to weld only twice, because the vertices on the left of the viewport are generated by the Symmetry modifier.)

This removes unnecessary edges while retaining the neck volume. Also, when you need to connect objects together (for example, this head with its body), synchronizing each object's polygon count facilitates the bridging process.

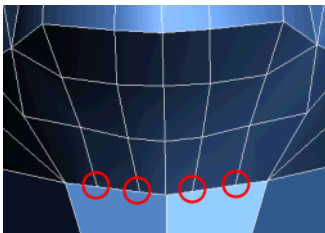

Before using Target Weld

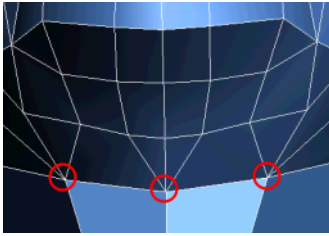



After using Target Weld

TIP If 3ds Max won't weld the two rightmost vertices, this might be because there are two vertices close to each other on the right side. Use Weld to weld these vertices, and then use Auto Weld to join the new single vertex to the one at the top of the neck.

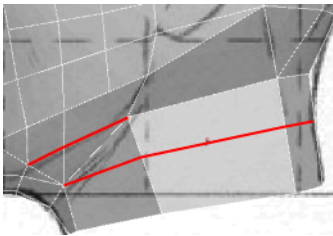
- 5 Turn on Cut and create two distinct sets of edges around the neck to better distinguish it from the jaw line.



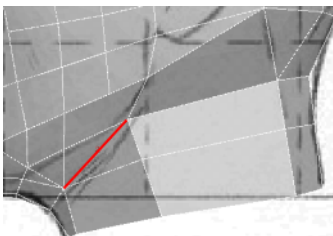

- 6   Go to the Edge sub-object level, then select the diagonal edge located near the jugular vein.



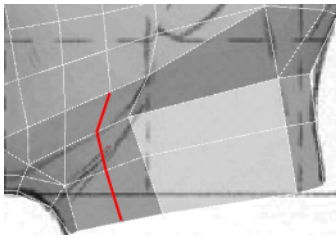

- 7 On the Edit Edges rollout, click Remove.

- 8 Use Cut to divide the neck polygons in the jugular region, and complete the vertical loop.



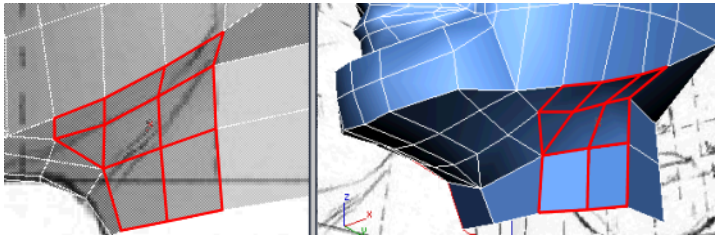

- 9   Turn off Cut, go back to the Vertex sub-object level, and reposition the new vertices to equalize their spacing and alignment.

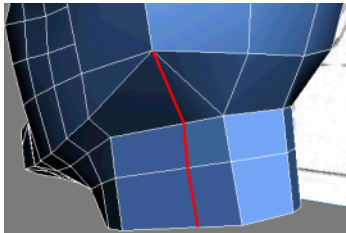

- 10  Orbit so you can see the back of the neck. Turn on Cut and draw a series of edges from the base of the skull down the neck.



- 11 Turn off Cut.

- 12   Go to the Edge sub-object level, and then select the diagonal edge that does not match the surrounding edge flow.

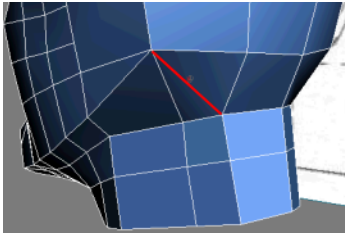

- 13 On the Edit Edges rollout, click Remove.

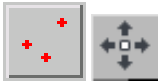

- 14 Go back to the Vertex sub-object level and adjust the vertices to round out the back of the neck.

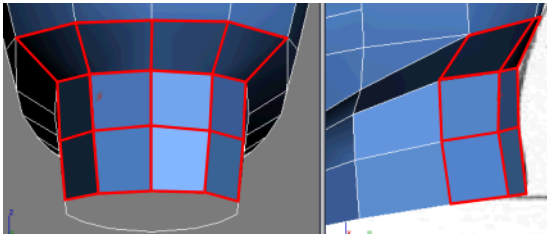

- 15 Save your file as **My_Low_Poly_Head_Neck.max**

Creating the Ears

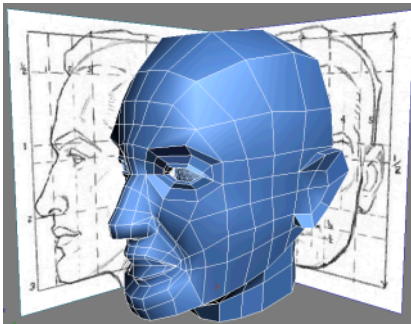

In this lesson, you take a minimalist approach to modeling the ears by using very rough shapes. Ears are complex structures that often are voluntarily

simplified. When your character is geared towards game production, a detailed texture converted into a normal map can substitute for a complex model.



Extrude the ears:

- 1  Continue working on your file from the previous exercise, or load the file *Low_Poly_Head06.max* found under *\modeling\low_polygon_modeling*.

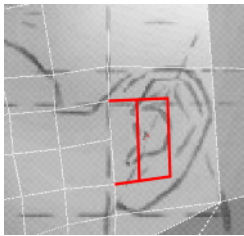
- 2  Go to the Polygon sub-object level. On the Edit Geometry rollout, turn on Cut and draw a series of edges around the tragus and ear canal.



- 3 Turn off Cut.

- 4   Select the polygons resulting from your last cut. Then, on the Edit Polygons rollout, click the Extrude Settings button.
- 5 In the Extrude Polygons dialog, set Extrusion Height to **10.0**. Click OK. This gives the ear its volume.

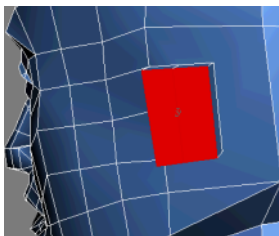

Next, you'll expand and shape the ear to match the reference image.



- 6 Select the polygons all around the extrusion except those in the front of the ear.

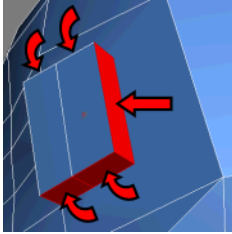

- 7 Click the Extrude Settings button again. In the Extrude Polygons dialog, set Extrusion Type to Local Normal and Extrusion Height to **15.0**. Click OK.

Each selected polygon is extruded along its respective normal. This defines the general mass of the ear.

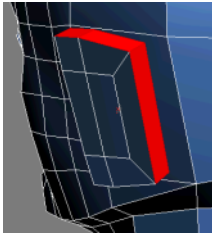

- 8 Keep your current polygon selection and move it slightly away from the head.

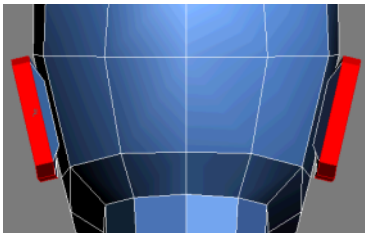

Refine the ears:

- 1  Go to the Vertex sub-object level. Click Target Weld and merge down the ear vertex highlighted in the following image:

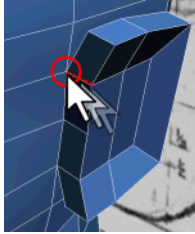

Before Target Weld

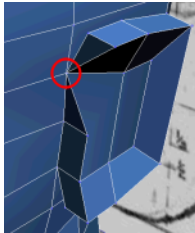

After Target Weld

- 2 Repeat the same step for the following vertices:

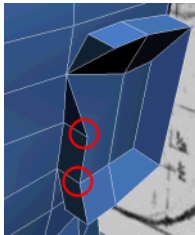

Before Target Weld

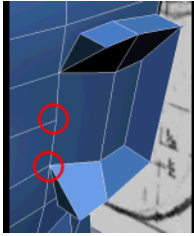

After Target Weld

- 3 Use the same technique two more times to merge redundant vertices at the starting point of the helix, which borders the ear.

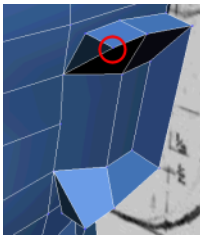

Before Target Weld

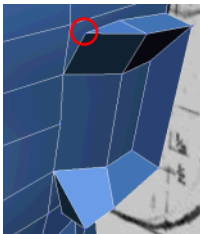

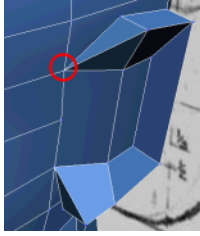

After first Target Weld

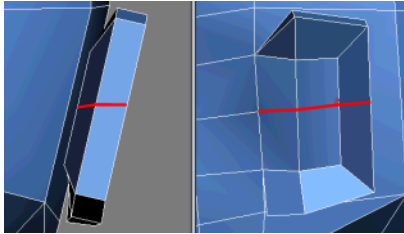

After second Target Weld

- 4 Turn on Cut, and starting from the head's existing edge loop located near the ear's anterior notch, divide the ear horizontally in half by going around the helix rim until you reach the other side, where the ear and head connect.



- 5  Adjust the ear's vertices to match the reference images.

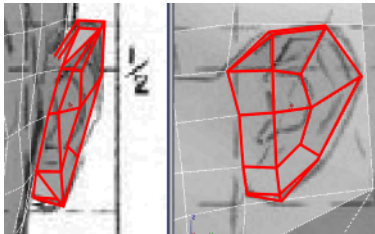

- 6 Use Cut to connect two vertices behind the ear to nearby head vertices. This breaks down the head polygons into manageable quads (four-sided polygons).

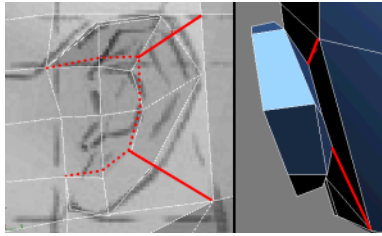

- 7 Using the same technique, connect the edge loop travelling through the ear to the back of the head.

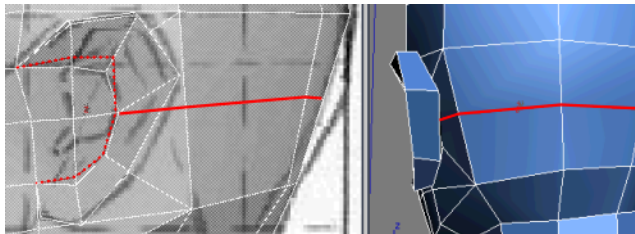

- 8 Use Target Weld to merge two separate sets of vertices behind the helix rim. This removes some expendable polygons.

TIP  To get a better view, turn off Show End Result, and use the Perspective viewport to look at the ear from within the head.

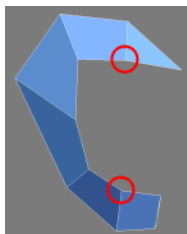

Before Target Weld

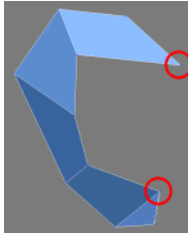

After Target Weld



- 9 Save your file as **My_Low_Poly_Head_Ears.max**

Creating the Helmet

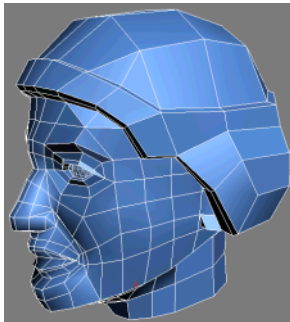
In this lesson, you use part of your character's head to create a helmet. Then, you extend the geometry to define a rim and ear protectors.



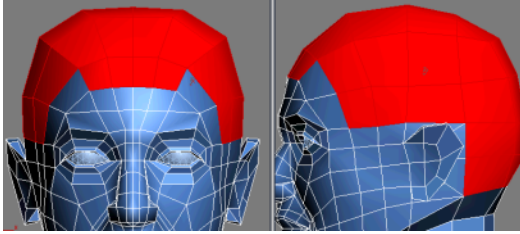

Bevel the helmet:

- 1  Continue working on your file from the previous exercise, or load the file *Low_Poly_Head07.max* found under *\modeling\low_polygon_modeling*.
- 2   Go to the Polygon sub-object level and select the head's polygons between the hair line and the base of the skull, excluding the ears.

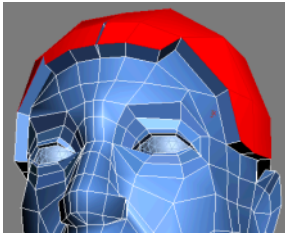

- 3  Click the Bevel Settings button. On the Bevel Polygons dialog, set Bevel Type to Local Normal and set Height to **10.0**. Click OK.



- 4  Click the light bulb icon next to the Symmetry modifier in the Modifier Stack.
This turns the modifier off so you can clearly see one half of the object.

- 5  Select the beveled helmet's inner polygons.

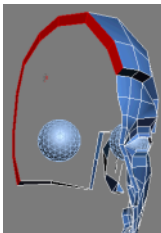

TIP On the Selection rollout, turn on Ignore Backfacing to avoid selecting faces that aren't on the inner side of the helmet.



- 6 Press the Delete key to remove the selection.

- 7  Select the following polygons:

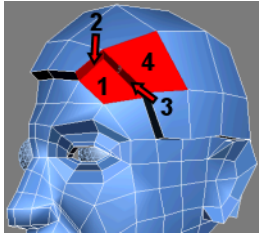
- The polygon over the eyebrow.
- The two polygons shaping the bevelled helmet's rim.
- The closest polygon on the helmet's side.



- 8 Press the Delete key to remove the selection.

- 9   Go to the Edge sub-object level and click the Bridge Settings button. On the Bridge Edge dialog, choose Use Edge Selection and select the three sets of border edges starting at the eyebrow. This leaves one face open on the helmet. Set Segments to 2 and click Apply when done.

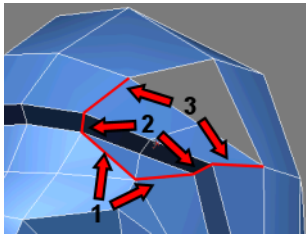

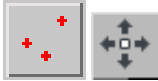
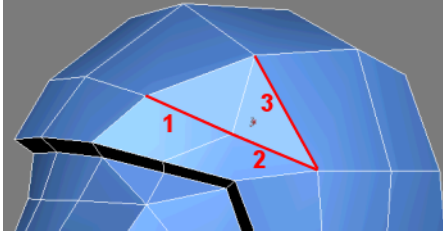

- 10 On the Bridge Edges dialog, set Segments to 1 and then select three of the four remaining edges to cover the last helmet gap. Click OK to create the new faces and close the Settings dialog.

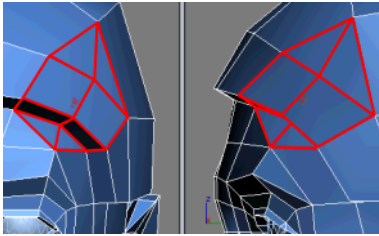

- 11 Go to the Vertex sub-object level and adjust the helmet's vertices to match the surrounding edge flow.

TIP For more accurate adjustments, move vertices using the Local coordinate system, as well as the Edge Constraint.



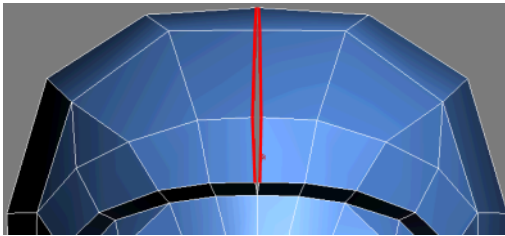

- 12  Click the Symmetry light bulb icon to turn the modifier back on. Notice the central gap in the helmet because of the middle vertices' offset along the X axis.





- 13 Turn on Move, select each vertex individually, and then on the status bar, right-click the spinner arrow next to the vertex's X position. This sets the X position back to 0.0.

TIP You can also adjust the *Symmetry modifier's* Threshold value to automatically include more vertices in the symmetry weld instead of selecting vertices manually.

Bevel the helmet's rim:

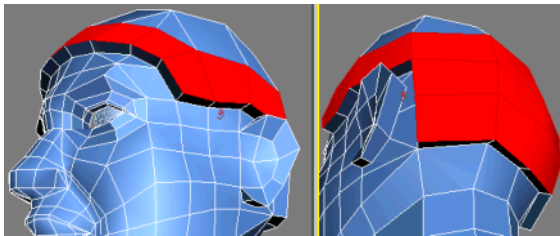
- 1   Go to the Polygon sub-object level and select the polygons shaping the helmet's rim, as well the portion at the back of the head.



- 2  Click the Bevel Settings button. In the Bevel Polygons dialog, set Bevel Type to Local Normal, Height to **5.0**, and Outline Amount to **-2.5**. Click OK.

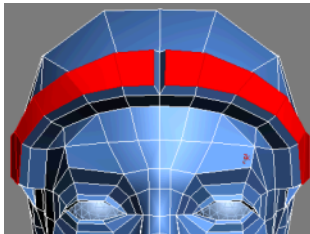

- 3  Select the inner polygons along the central axis.

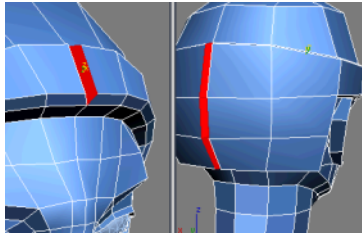

- 4 Press the Delete key to remove the interior polygons.



- 5 Go to the Vertex sub-object level, turn on Move, and reset the respective vertices' X position to **0.0** to close the gap between the sides of the helmet.

Define the ear protector:

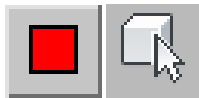

- 1 Go to the Polygon sub-object level, and then select the polygons surrounding the ear.

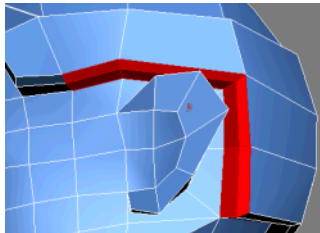



- 2 Press the Delete key to remove them.



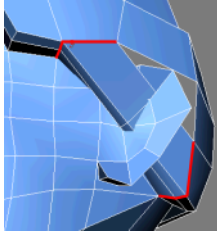

- 3 Go to the Edge sub-object level and click the Bridge Settings button.
- 4 In the Bridge Edges dialog, choose Use Edge Selection and set Segments to **2**. Select three edge pairs from the leading edge of the outer rim. Click OK.

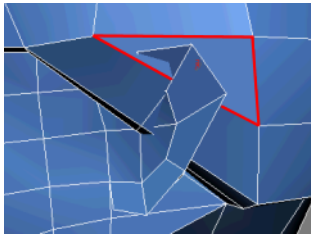

- 5   Go to the Border sub-object level. Select the remaining border edges, and on the Edit Borders rollout, click Cap.



- 6   Go back to the Vertex sub-object level and redistribute the vertices to better cover the ear.

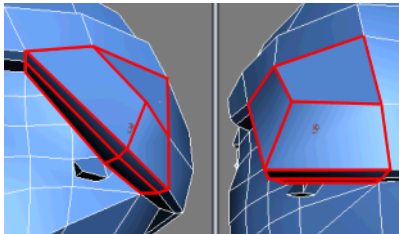

- 7  Go to the Edge sub-object level. Use the Cut or Connect tool to create a series of edges at ear level. Connect these edges at the back of the helmet.

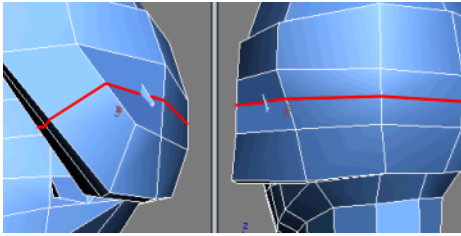

- 8 Reshape the new edges to give the ear protector more volume.

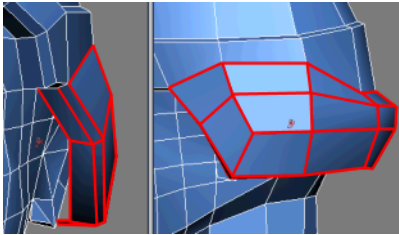

- 9 Save your file as **My_Low_Poly_Head_Helmet.max**

Taking it Further: Refining Inside the Ear Protectors

Use the tools and techniques learned in this lesson to create the inner part of the ear protectors. For example, you could use the Bridge tool to create new polygons from the current edge border, and then add some extra edges to bring the resulting vertices around the ears.

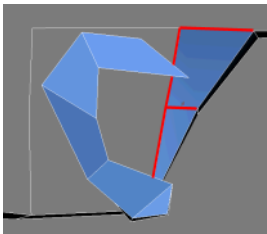

1. Use the **Bridge** and **Cut** tools to link edges together.

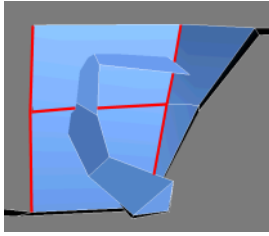

2. Bridge the remaining edges.

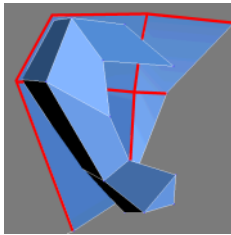

3. Adjust the vertices so the helmet doesn't obstruct the ears.

Creating the Visor

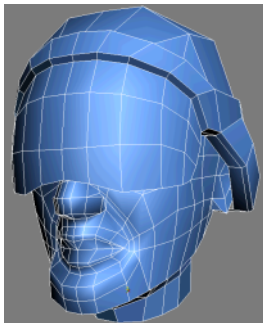

In this lesson, you create a visor using the front side of the helmet as a starting mold. This visor is modeled as a separate object and reattached to the helmet at the end.

Create the visor:

- 1  Continue working on your file from the previous exercise, or load the file *Low_Poly_Head08.max* found under `\modeling\low_polygon_modeling`.

- 2   From the Create panel, choose Shapes.

- 3 On the Object Type rollout, click the Line button.

- 4 In the Right viewport, draw a line with four vertices in front of *Low-Poly-Head*. Right-click the active viewport to end line creation, then right-click again to exit the Line tool.

This new line serves as path for the visor.

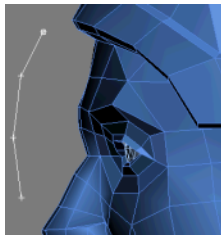

- 5  Select *Low-Poly-Head*, then go to the Modify panel.

- 6  Go to the Polygon sub-object level and select the helmet polygons closest to the forehead.

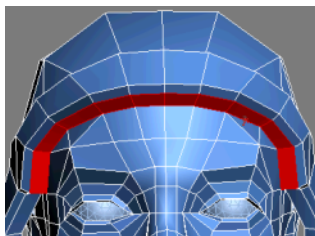

- 7 On the Edit Geometry rollout, click Detach.

- 8 In the Detach dialog, rename your object **Low-Poly-Visor** and turn on Detach As Clone. Click OK.
This duplicates your selection as a separate object.



- 9 Exit the Polygon sub-object level.



- 10 Click Select By Name (or press the H key). In the Select From Scene dialog, double-click *Low-Poly-Visor* to select it.

NOTE The object comprises only one half of the helmet-rim polygons. When you detach sub-objects into separate objects, they do not inherit their former object's modifiers (in this case, the Symmetry modifier).



- 11 Go to the Polygon sub-object level. If the rim polys are not automatically selected, select them.

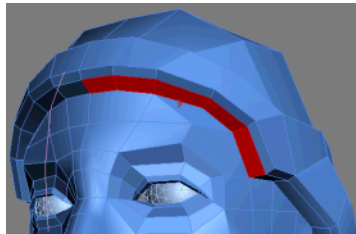

- 12 On the Edit Polygons rollout, click the Extrude Along Spline Settings button. On the Extrude Polygons Along Spline dialog, click Pick Spline and select your newly drawn line. Turn on Align To Face Normal, set Segments to **3**, and reset all remaining options to **0.0**. Click OK.

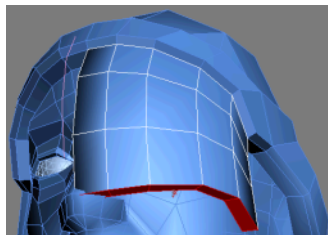



- 13  Exit the Polygon sub-object level.

Define the visor:

- 1  Select *Low-Poly-Head* and toggle See-Through mode (Alt+X). Then right-click the active viewport and choose Freeze Selection from the quad-menu.

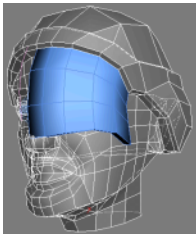

Now you can edit the visor without accidentally selecting the character's head or helmet.



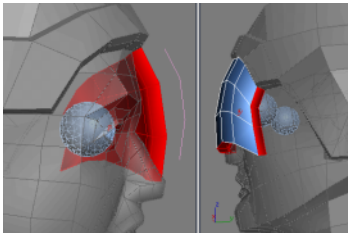

- 2   Select the *Low-Poly-Visor* and go to the Polygon sub-object level. Then select the inner side of the visor, as well as any border polygons.

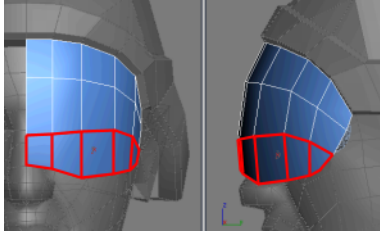

- 3 On the Edit Polygons rollout, click Delete to remove these unnecessary faces.

- 4   Go to the Vertex sub-object level and adjust the visor's vertices to curve the lower part.



- 5  Exit the Vertex sub-object level, then right-click the active viewport and choose Unfreeze All.
- 6 Select the *Low-Poly-Head* and toggle See-Through mode (Alt+X).

- 7  Go to the Element sub-object level and, on the Edit Geometry rollout, click Attach.
- 8 Select *Low-Poly-Visor*.

The helmet integrates the visor's geometry as a distinct element. Notice that now the Symmetry modifier automatically mirrors the visor half as well as the head.

- 9 Save your file as **My_Low_Poly_Head_Visor.max**

Next

[Making the Final Adjustments](#) on page 369

Making the Final Adjustments

If you completed all the preceding tutorials in this section, you should by now have created all the components that make the soldier. Still, as you look at the results in the viewports, the objects look faceted. Some modifiers that fix this issue, such as MeshSmooth and TurboSmooth, do so by adding geometry to the objects, which defeats the purpose of low-poly modeling. It

is best to keep the face count low by adjusting smoothing groups on the objects.

In a nutshell, two adjacent polygons that do not share the same smoothing group appear separated by a visible edge, giving the shading a faceted look. If the two polygons share the same smoothing group, the edge becomes invisible, giving the illusion of a smooth, curved surface. You can use the Smooth modifier to quickly adjust smoothing groups without adding geometry.



In this tutorial, you will learn how to:

- Apply the Smooth modifier to eliminate visible polygon edges on a model and blend shapes of sub-objects.

Skill level: Beginner

Time to complete: 20 minutes

Adjusting Smoothing Groups

Apply a smooth modifier to parts of the body:

- 1  On the Quick Access toolbar, click the Open File button, navigate to `\scenes\modeling\low_polygon_modeling` and open the file `soldier04.max`.

- 2  In any viewport, select the shirt.

- 3  From the Modify panel, apply a Smooth modifier.
- 4 In the Parameters rollout, choose any smoothing group number.
This forces all polygons on this shirt object to share a single smoothing group, eliminating any visible edges.



TIP In the viewport you are using, click the Shading viewport label menu and turn off Edged Faces to see the effect of smoothing.

- 5 Select the pants and apply a Smooth modifier as you did with the shirt.
- 6 Choose a smoothing group number that is different from the one you used for the shirt.
Again, this smooths the polygon edges. In this case though, it might be slightly overdone, since you might want a stronger edge between the belt and the pants.



- 7 Turn on Auto Smooth and set Threshold to **70.0**. Smoothing is now performed based on an angle threshold that you specified, separating the belt from the pants.



- 8 Continue applying the Smooth modifier to the rest of the objects. Try out both methods (Auto Smooth versus manual) where you see fit.



NOTE Remember that you need to apply Smooth to only one boot and one arm, as you instanced these two objects to create the opposite limbs.

Merge the Head and Apply Smoothing Groups to its Sub-Objects

The last remaining step is to combine the soldier's head with his body, and use smoothing groups once more to help blend the polygons together. This time, though, you apply the smoothing groups to the head using selection sets at the sub-object level.



- 1 From the Application menu, choose Import > Merge. On the Merge File dialog, browse to the same folder as the other scene files, `\modeling\low_polygon_modeling\`, and open *Head_Helmet_Visor.max* from the Merge File dialog.

- 2 On the Merge dialog, highlight *Low-Poly Head*, and then click OK.
The soldier's head now rests on top of his body, except that the head is still faceted.



- 3  Go to Modify panel, then go to the Polygon sub-object level.

- 4  Turn on Show End Result to have a better view.

- 5 On the main toolbar, expand the *Named Selection Sets* drop-down list.
The list already contains a few selection sets associated with either the face or the helmet.

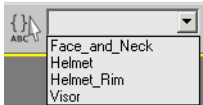

- 6 Choose *Helmet* from the list.
This selects all helmet polygons, excluding those that give the helmet its depth.

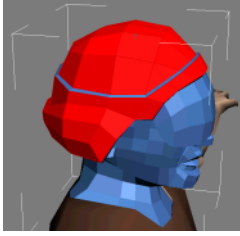

- 7  On the Polygon Properties rollout of the Modify panel, choose any smoothing group number.

This smooths the edges between the helmet polygons. Note the distinctive hard edge between the helmet and its rim.

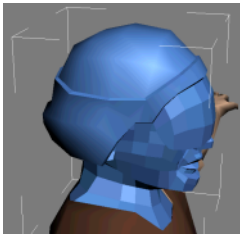

- 8 Choose *Visor* from the list, then select a different smoothing group number than the one you used for the helmet.

The visor looks more believable with smoothing groups.

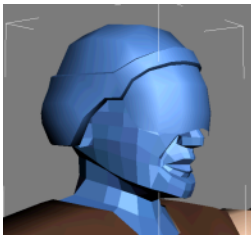

- 9 Finally, choose *Face_and_Neck* from the list.
- 10 Choose another smoothing group, or click Auto Smooth with different threshold values to get similar results.

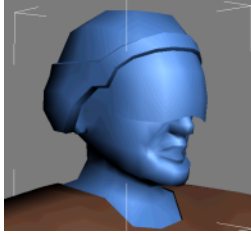

Summary

This tutorial has introduced you to several of the tools you can use to make a low-polygon model with editable poly functionality. These tools can be adapted to the task of modeling any low-polygon character.

A finished version of the file, *soldier_completed.max*, is provided in the folder `\scenes\modeling\low_polygon_modeling\`.

Modeling Level Design

In this tutorial, written for games professionals, you will rapidly build a level with some boxes for buildings. You'll learn about creating and adjusting materials and mapping to design how the neighborhood looks, and use XRef objects to add street lamps and some trees. You'll use vertex lighting and vertex paint to prepare your model for export.



In this tutorial, you will learn how to:

- Apply Taper and Blend modifiers to box objects.
- Use the Material Editor to create and blend materials.
- Map materials to objects.
- Merge objects in a scene.
- Add objects to a scene using XRef Objects and Object Painter.
- Illuminate scenes using Omni and directional lighting.
- Adjust lighting using Vertex Paint.

Skill level: Beginner



Time to complete: 45 minutes

Creating a Building



In this lesson you'll create a building from a Box object with Taper and Bend modifiers applied. This is probably the simplest modeling you can possibly do; it's the materials that do most of the work in creating the art. To build this level, start by building a box.

Create the box object:

- 1  On the Quick Access toolbar, click the New Scene button.
- 2  On the Create panel > Object Type rollout, click Box.
- 3 In the Perspective viewport, drag out a box. This sets the box width.

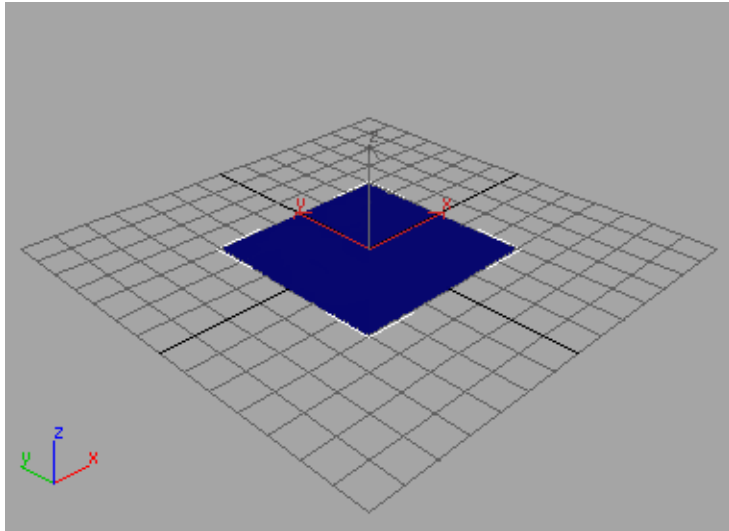

- 4 Release the mouse button and continue to drag to specify the height.

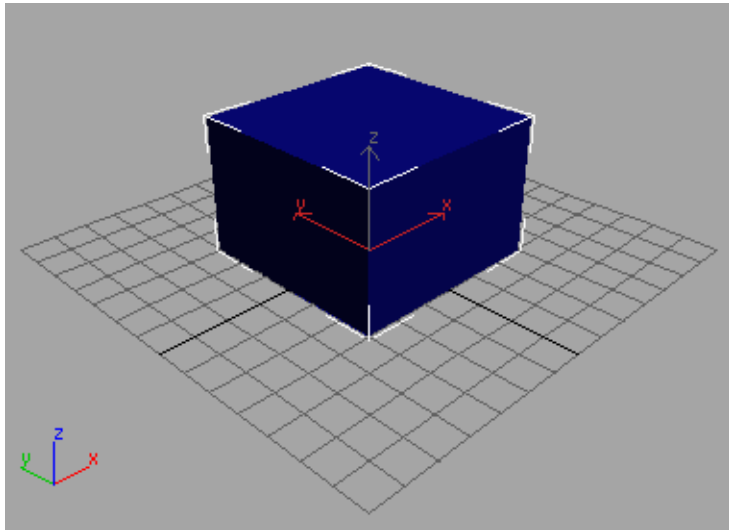

- 5 Click again to set the height of the box.



- 6 Go to the Modify panel > Parameters rollout and set the following box parameters:

Length=17

Width=19

Height=42

As long as the box remains a parametric object, you can always access and change these values by selecting the object and opening the Modify panel.

The box is going to be deformed, so you'll want some extra segmentation in the object.

- 7 Click in the Length Segs field, and change the value to 2.
- 8 Press the Tab key to move to the Width Segs field, and change the value to 2.
- 9 Press the Tab key to move to the Height Segs field. Change the value to 4.
- 10 In the Perspective viewport, click the Smooth + Highlights label and choose Edged Faces. Now you can see the segments in shaded mode.

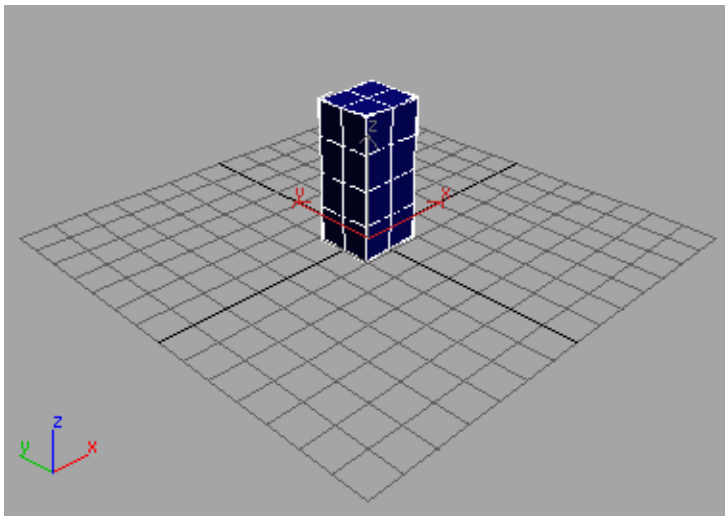

Add modifiers:



- 1 Go to the Modify panel > Modifier List, choose Object-Space Modifiers > Taper from the list.

TIP You can quickly find a modifier by typing the first letter. In this case, entering **T** on the keyboard will highlight Taper from the list.

Taper the box by changing the parameters in the rollout.

- 2 On the Parameters rollout, in the Taper group, change Amount to **0.6**.

TIP You can click the spinner arrows, click the spinner arrows or type in the values to change the amount of the taper.

- 3 Change Curve to **-0.61**.

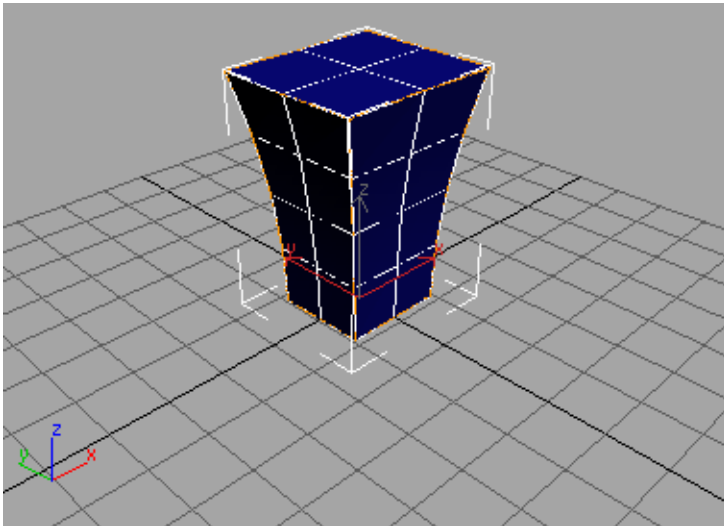

Next you'll add a Bend modifier.

- 4 On the Modifier List, choose Object-Space Modifiers > Bend.
- 5 On the Parameters rollout, in the Bend group, change Angle to **10.5**.
- 6 Change Direction to **55**.

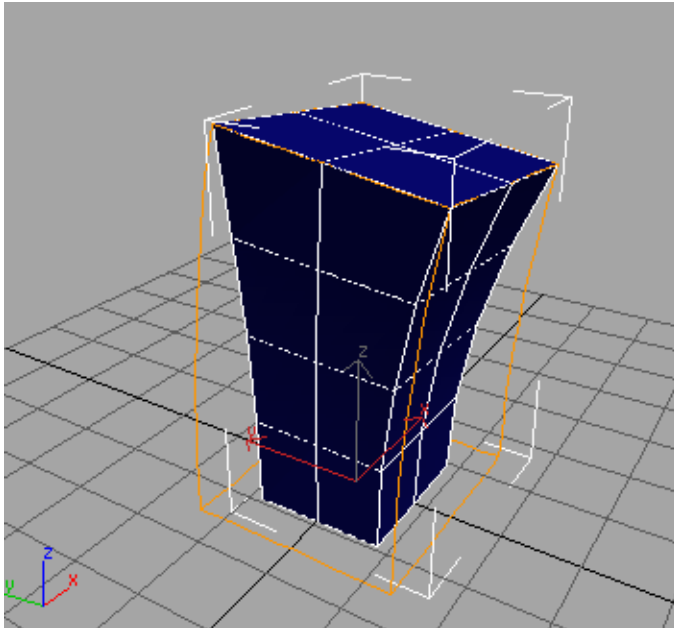

You can adjust the height of the box after applying the Taper and Bend modifiers.

- 7 In the modifier stack display, click Box. It turns gray to show it is selected.

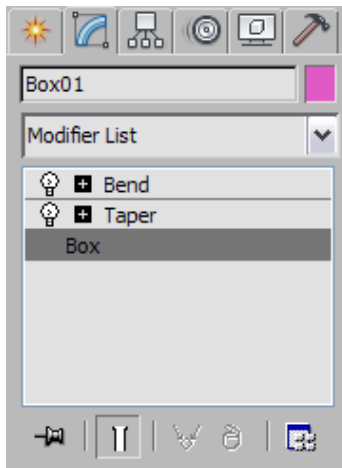

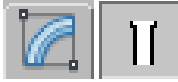

- 8 In the Modify panel, make sure the Show End Result On/Off Toggle is on.
- 9 Change the height of the box using the spinner arrows. Don't make the box so high you can't see the top in the viewport.
- 10 Save your scene as **mybuilding.max**.
You've just made the form for a building with cartoon attitude. Next you'll add materials to turn this pinched column into a cartoon garage.

Adding Mapping and Materials for the Building

You are going to use three different mapping and material channels to create the look of this building. First, you will map the bricks and windows to the walls. Then you'll hang a sign on the front of the garage and add a black tar roof.

Drag materials to the box:

You'll drag materials from the Asset Browser to the box to transform it into a garage.

- 1 From the menu bar, choose Rendering > Environment. The Environment And Effects dialog appears. In the Global Lighting group click the Ambient color swatch. Drag the Whiteness slider down to a light grey, then click OK.

This will lighten up the scene so you can see the results of any change to materials and rendering tests.

- 2 Close the Environment And Effects dialog.



- 3 Select the box in the viewport if it isn't still selected, and open the Modify panel. Open the Modifier List and choose Object-Space Modifiers > UVW Map.
- 4 In the modifier stack display, drag the UVW Mapping modifier downward, placing it between the Taper and the Box.

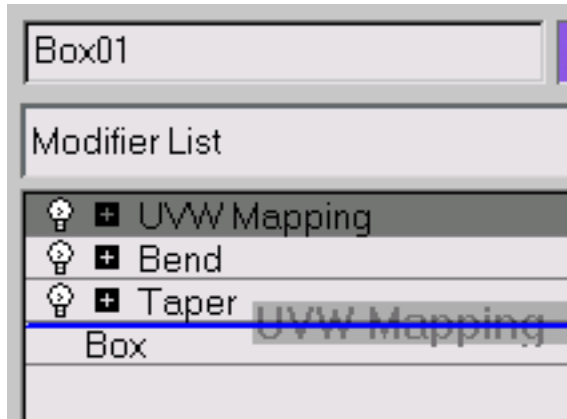

TIP You can drag and drop modifiers to rearrange them in the stack display. Hold down the Shift key to make a copy; hold down Ctrl to make an instance.

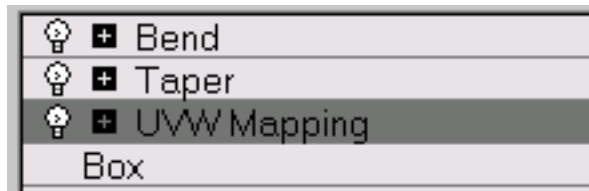

- 5 In the Parameters rollout, change the Mapping style from Planar to Box. Now any mapping you apply will appear on each side of your building.

- 6  Turn off the Show End Result On/Off Toggle.
- 7 Click the plus icon to expand the UVW Mapping modifier in the modifier stack, then click the Gizmo entry to make this the active sub-object level. The original box displays without the Taper or Bend modifiers.
- 8 From the Parameters rollout, adjust the Length and Width of the gizmo so it conforms more closely to the box. If necessary, move the gizmo to encompass the box.
- 9 Use the ViewCube to view the gizmo from several angles to make sure it properly fits the box.

-
- 10 **IMPORTANT** The gizmo needs to be resized so that it almost has the same dimensions of the box. If the gizmo isn't fitted properly, the mapping will not be correct.
-

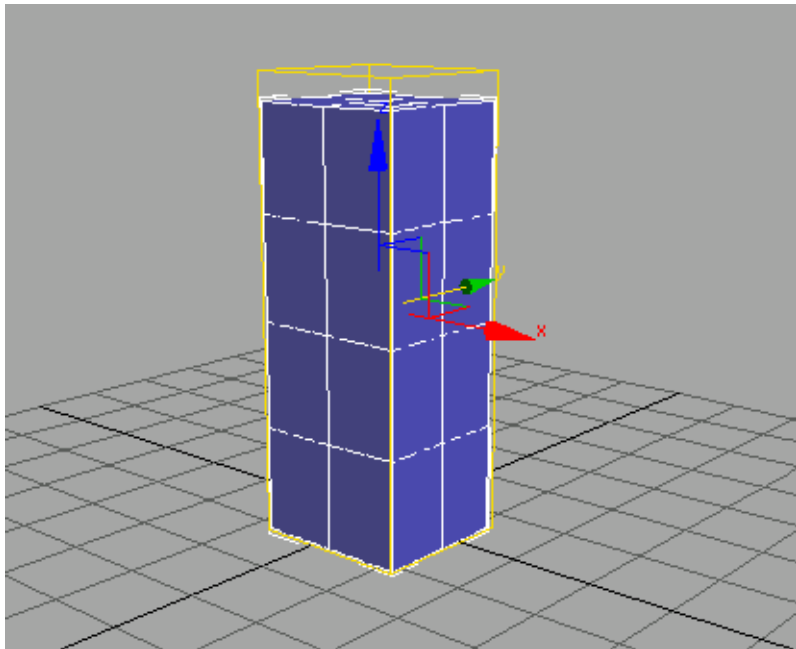

Gizmo is resized so that it fits the box like a glove



- 11 On the Utilities panel, click Asset Browser.
- 12 Use the Asset Browser to navigate to the `\sceneassets\images\` folder. Minimize the Asset Browser for now. You'll need it later when you apply a map to your box.
- 
- 13 Open the Modify panel and click Bend in the modifier stack display to select the top of the stack.
- 14 Go to the Modifiers menu and choose Mesh Editing > Edit Mesh. The Edit Mesh modifier appears at the top of the stack.



- 15 On the Modify panel, in the Selection rollout, click Polygon.

TIP If you expand the Edit Mesh entry in the modifier stack, the sub-object levels are displayed and Polygon sub-object level is active.

- 16 Turn on Ignore Visible Edges.
- 17 Click the side of the box that will be the front of the garage. All the polygons turn red.

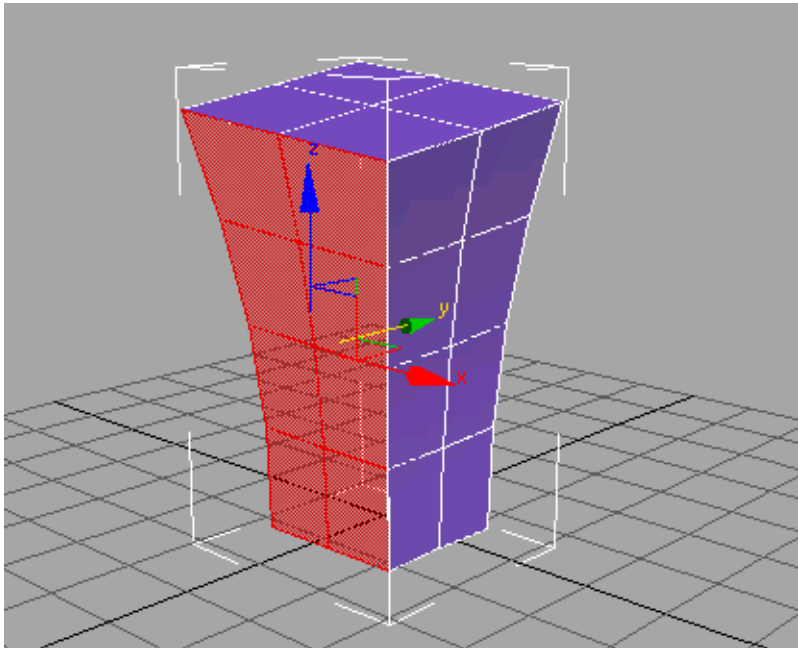

- 18 Restore the Asset Browser. Drag *bfrontgarage.jpg* and drop it on the selected polygons.
Typically the box will change to a white color once you assign the map. This is normal. (If you use an OpenGL driver for viewports, it might show the bitmap itself.)
- 19 Click the other side of the box that will be the side of the garage.
- 20 From the Asset Browser, drag *bsidegarage.jpg* to the selected polygons.

You can now minimize the Asset Browser.

- 21  Make sure the Modify panel is active once again.

- 22  In the Selection Rollout, click the Polygon button to turn it off.

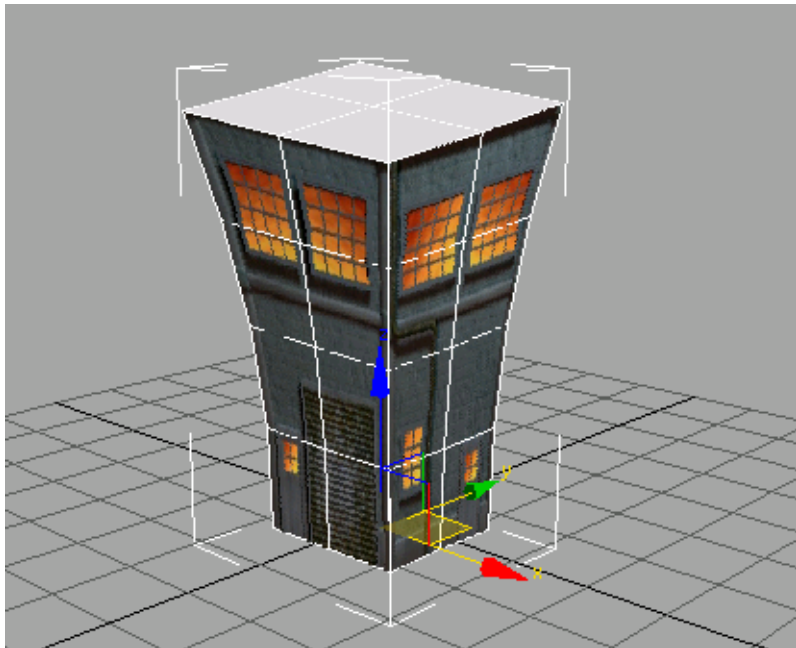

TIP You can also click the top-level Edit Mesh entry in the modifier stack.



Your building shows the front and side mapping.

Add a garage sign texture:

You'll now use the Material Editor to create a multi/sub-object material that consists of the materials that will transform the box into a “cartoony” garage.

-  On the main toolbar, click the Material Editor button.
-  In the Material Editor, click the Pick Material From Object button and then click anywhere on the box.
The garage materials you applied appear in the first sample slot.
- The material is a bit dark. To make it easier to see, you can increase the multiplier of the lighting of the sample spheres. Right-click on the highlighted sample sphere and choose Options. On the Material Editor Options dialog change the Top Light and Back Light Multipliers to **2.0** and then click OK.

Name the material **Garage**.

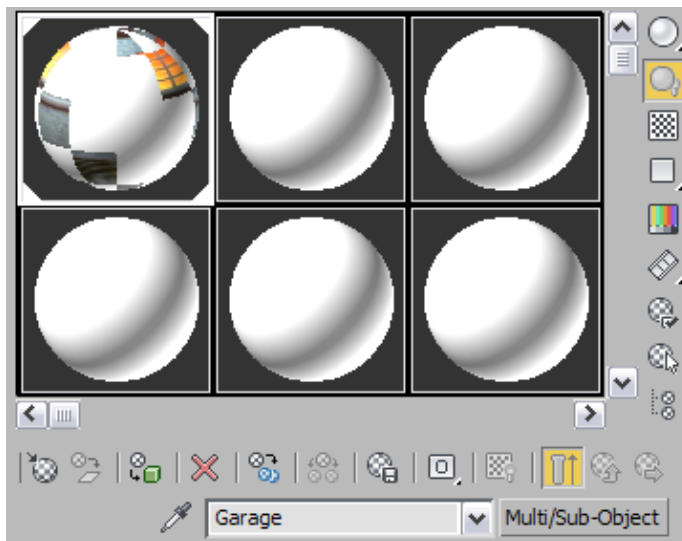

Garage material shown on sample sphere

- 4  Change the sample sphere to a cube by clicking the cube on the Sample Type flyout on the toolbar on the right side of the Material Editor.



The sample is now box-shaped. If you don't see the two different sides of the mapped box, right-click in the sample sphere and choose Drag/Rotate, then rotate the box within the Material Editor sample.



Magnified view of the Garage material

TIP Double-click the sample to magnify the sample slot. This will give you a better view of changes you make to the material.

Next you will replace one of the standard materials with a blend material within the multi-sub/object material.

- 5   On the Modify panel, click the Polygon button and select the side of the box that is the front of the garage. In the Surface Properties rollout, in the Material group, make a note (mental or otherwise) of the ID number.



- 6 Click Polygon again to turn it off.
- 7 In the Material Editor, in the Multi/Sub-Object Basic Parameters rollout, locate the material ID for *bfrontgarage*, then click its material button.
The Material name changes to the name of the material with the selected ID.
- 8 Click the Standard button to display the Material/Map Browser.
- 9 Select Blend, then click OK. In the Replace Material dialog that displays, click OK to keep the old material as a sub-material.
This creates a blend material that will consist of the *bfrontgarage* bitmap and the garage sign bitmap you'll add in the next step.
- 10 Open the Asset Browser again. Drag *garagesign.jpg* to the Material 2 button in the Blend Basic Parameters rollout in the Material Editor.
- 11 Next drag *bfrontgaragemask.jpg* to the Mask button labeled None.
The button label changes to reflect the filename.

NOTE The Asset Browser takes the file type into account when it alphabetizes, so probably you will need to scroll to find the mask map.

- 12 Name the material **Garage Front with Sign**.

You will now make modifications to the size of the garage sign bitmap so that it fits within the opaque area in the mask.

- 13 Click the Material 2 button.
- 14 In the Blinn Basic Parameters rollout, click the button labeled 'M' next to the Diffuse color swatch.

TIP If you hold the mouse over the button, *garagesign.jpg* should appear.

- 15 In the Bitmap Parameters rollout, in the Cropping/Placement group, turn on Apply, then choose Place.
- 16 Click View Image to display *garagesign.jpg* in the Specify Cropping/Placement dialog.



Here you'll change the overall dimensions of the bitmap so that it will fit within the area specified in the mask.

- 17 Enter the following values in the U, V, W, H fields:

U=0.11

V=0.45

W=0.80

H=0.15

The garage sign changes size. Close the window after entering these values.

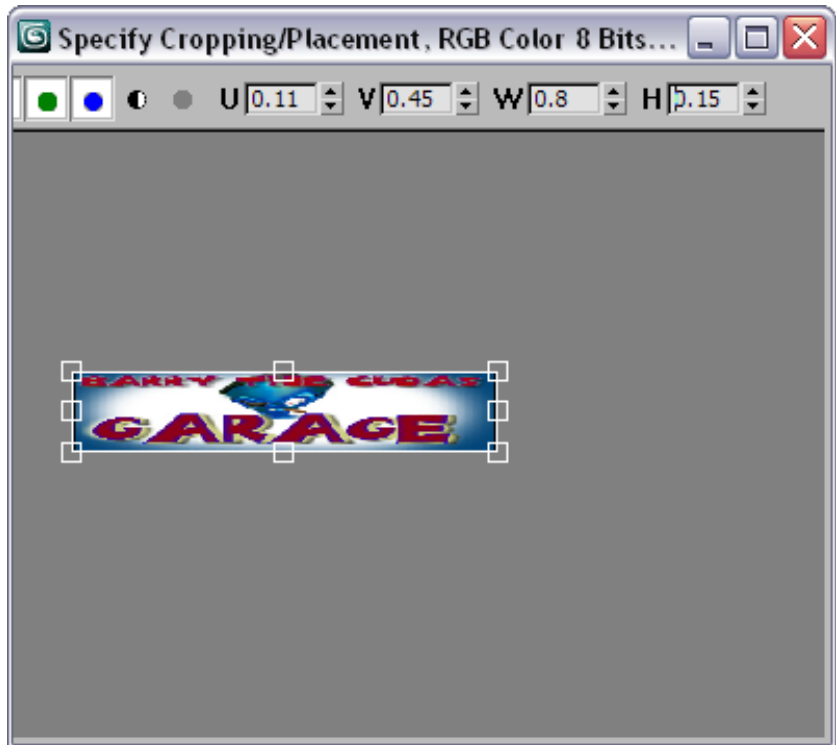

Garage sign bitmap resized

18  Click the Go to Parent button three times.

19  On the main toolbar, click the Render button (or press F9) to render the scene.



You can see the Blend material displayed in the Material editor and in the rendering. But you can't see the Blend material in the viewport, unless you happen to have the right combination of drivers and graphics card.

Make a black material for the roof:

- 1 In the Material Editor, in the Multi/Sub-Object Basic Parameters rollout, click the Material button for ID #1.
- 2 In the Blinn Basic Parameters rollout, click the Diffuse color swatch. The color selector appears.
- 3 Drag the Whiteness slider up to create a black color, then close the color selector.
- 4 Name the material **Black Roof**.
The roof of the garage turns black in the viewport.

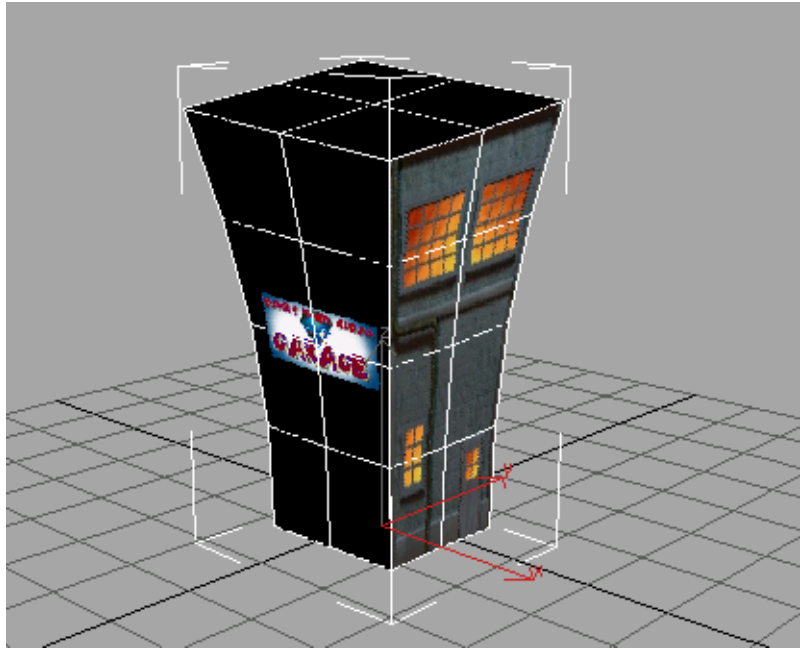

- 5  Click the Go To Parent button. Close the Material Editor.
- 6 Render the scene to see the final results.
- 7 Save your work as **mygarage.max**.

Merging the Building into a Neighborhood

In this procedure, you'll merge the building into a neighborhood.

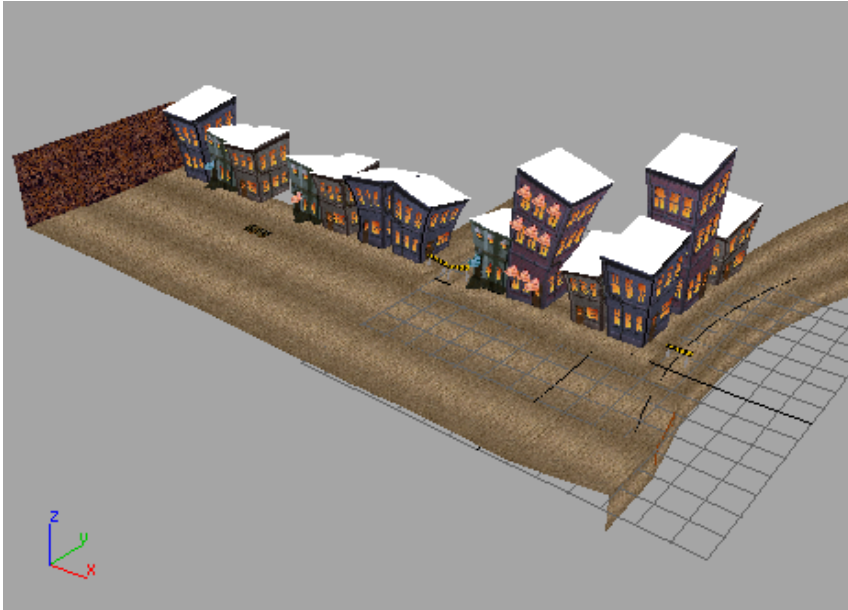

Merge the building into a neighborhood:

- 1  On the Quick Access toolbar, click the Open Scene button, then navigate to `\modeling\level_design` and open `city.max`.
This might take a while, depending on the speed of your machine.
- 2 Change three viewports to wireframe shading. Leave the upper Perspective viewport shaded.



- 3 From the Application menu, choose Import > Merge, then navigate to the `\modeling\level_design` directory, and choose `garage.max`.
- 4 Choose **Garage** from the list of objects to merge. Click OK.
The garage appears in the viewports. It is the only one with a black roof.



- 5 Right-click **Garage** and select Move from the quad menu.



- 6 Use the transform gizmo corner to move the garage Instead of the arrowheads. This will let you move freely along the ground plane without shifting the building up or down.



- 7 Move the garage into place between the third and fourth buildings from the left.

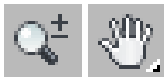
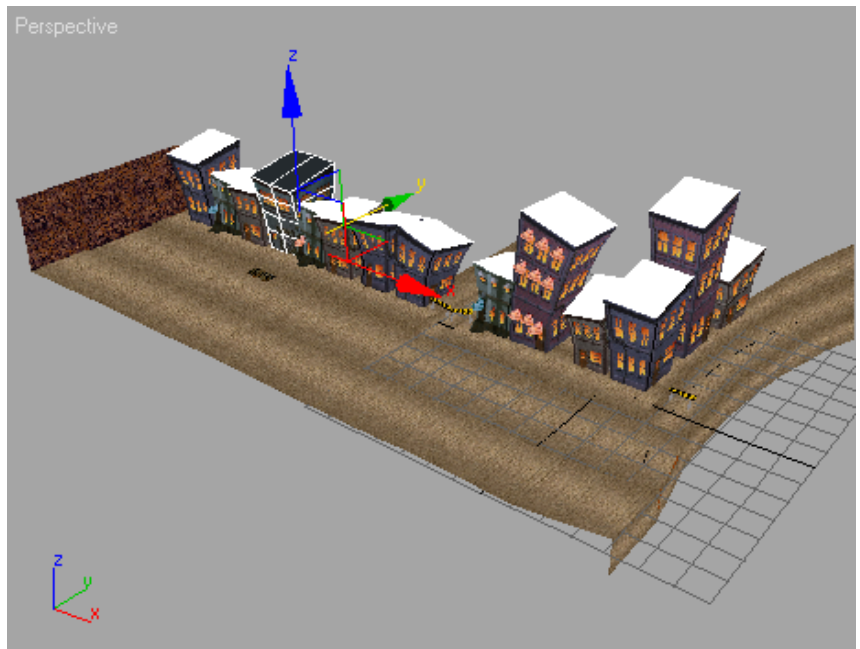

- 8 Activate the lower-right Perspective viewport. Zoom and pan to get a good view of the building.

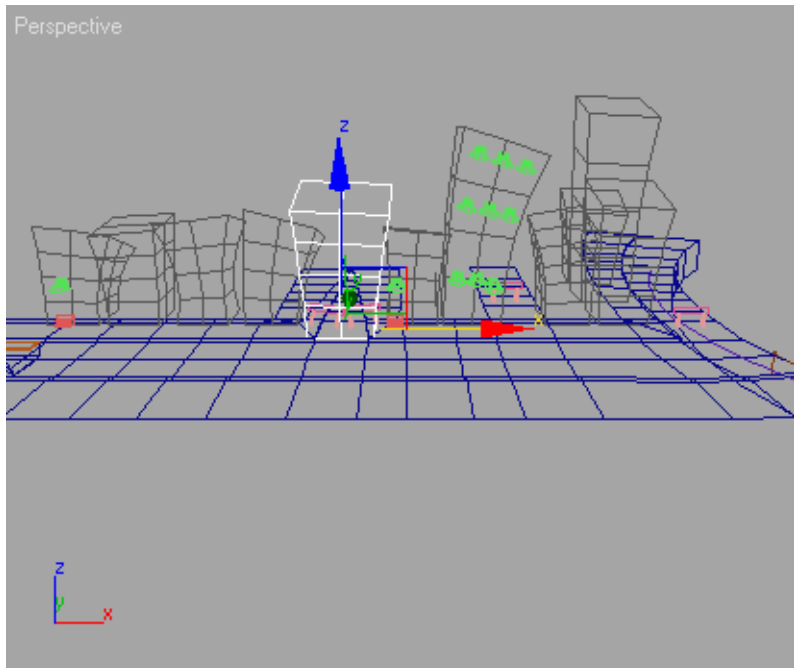

- 9  Choose the Region Zoom button in the viewport navigation controls, so you can see the building up close. Drag a zoom window around the building, then release the mouse.



- 10 Change the viewport back to Smooth + Highlights.



- 11  Adjust the scale of the building so it fits better with its neighbors. Right-click anywhere in the viewport and choose Scale from the quad menu. Then use the X axis of the Transform gizmo to scale the building to fit in.
- 12 Save your file as **mytoonstreet.max**.

Adding a Streetlight Using XRefs

You can add a streetlight to the scene using XRef Objects. First, you will open the streetlight scene and use XRefs to help correct the scale of the streetlight before you add it to the street.

Use XRef objects:

- Open the scene file *streetlight.max*.

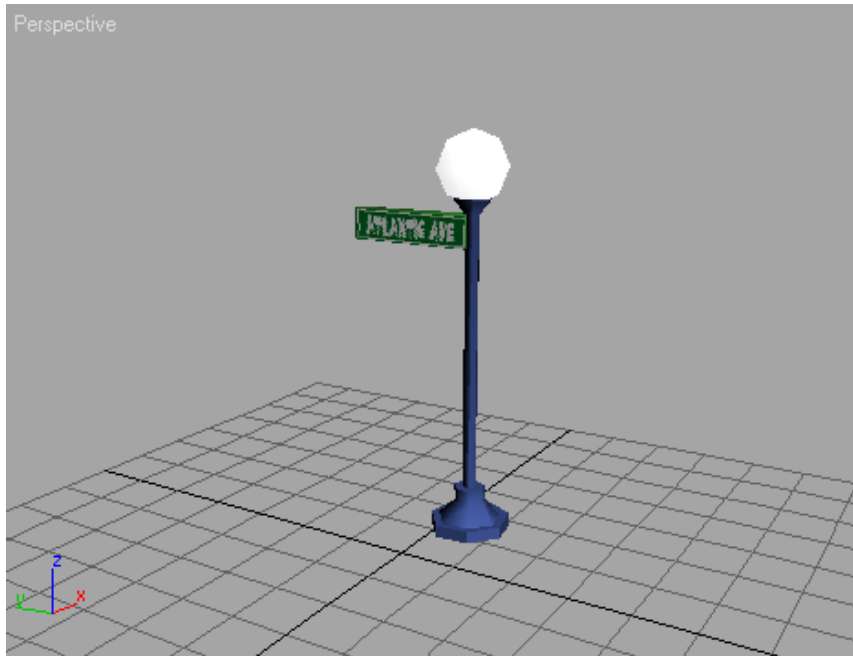

Instead of using measuring tools like the Tape helper or the Measure utility, you will instead use the scene itself, through XRefs.

Scale the street lamp:



- 1 From the Application menu, choose References > XRef Scene.
- 2 In the XRef Scenes dialog, click Add.
- 3 Navigate to the `\modeling\level_design` directory and select *Toonstreet.max*. A thumbnail appears in the Open File dialog when you highlight the name in the list.



The path and name of the XRef scene appears in the XRef Scenes dialog. After a pause, the scene also appears in the viewports.

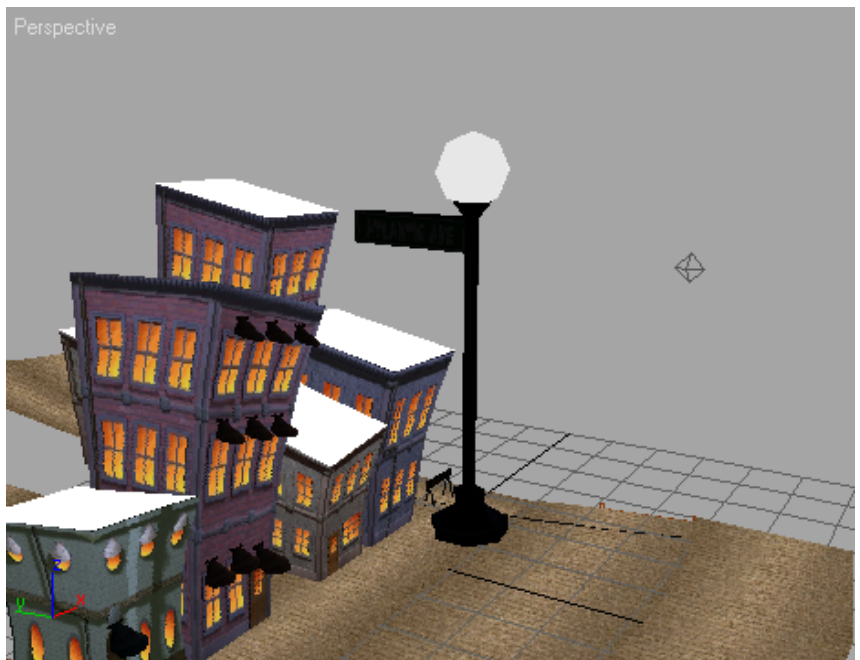

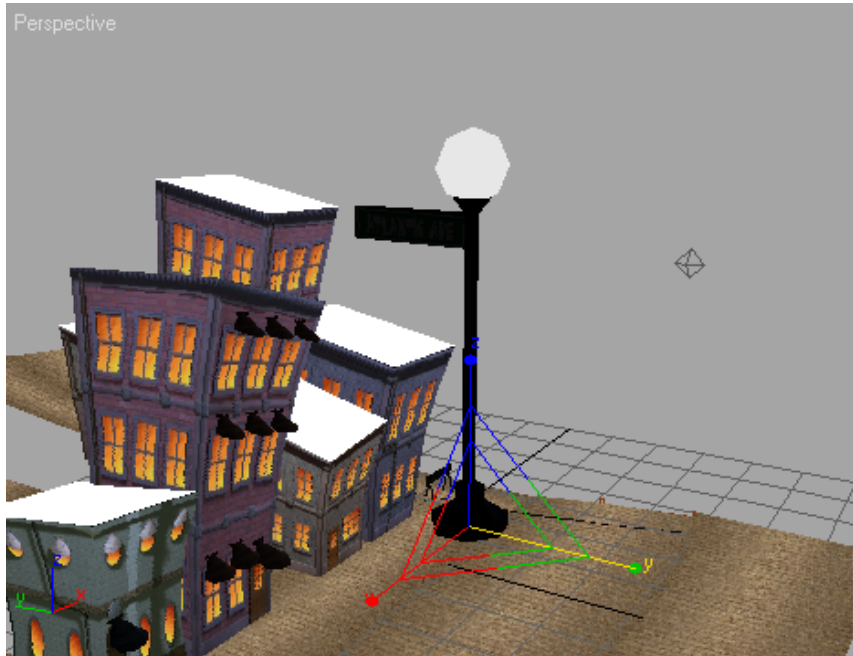

4 Close the Xref Scenes dialog.

- 5  Click Select And Uniform Scale and then select the street light. Scale down the street lamp using the scale gizmo so that it fits in the scene.

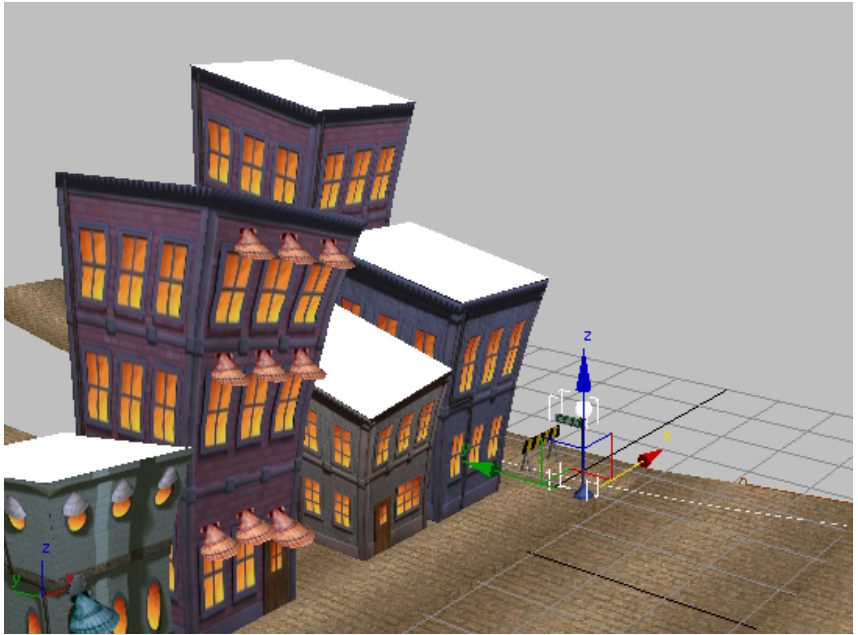

- 6 Move the scaled lamp so it's on the street corner.



- 7  Use Orbit to rotate the viewport for a look from a different angle. Scale the streetlight some more, if necessary.

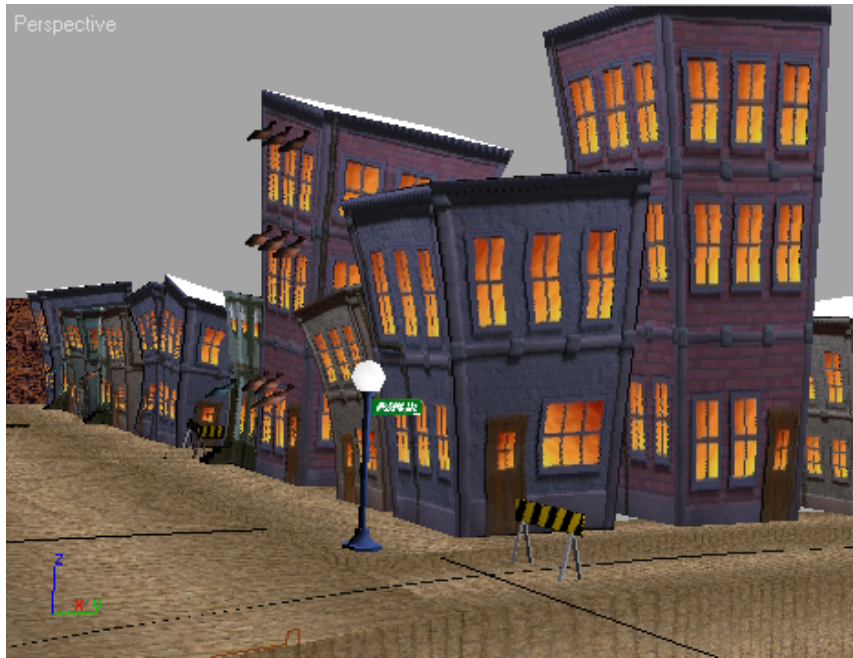

- 8 Now remove the XRef Scene. From the Application menu, choose References > XRef Scene to open the XRef Scenes dialog. Click *toonstreet.max* to highlight it, and then click the Remove button. The lamp post stands alone, in place and proportionate to the street.

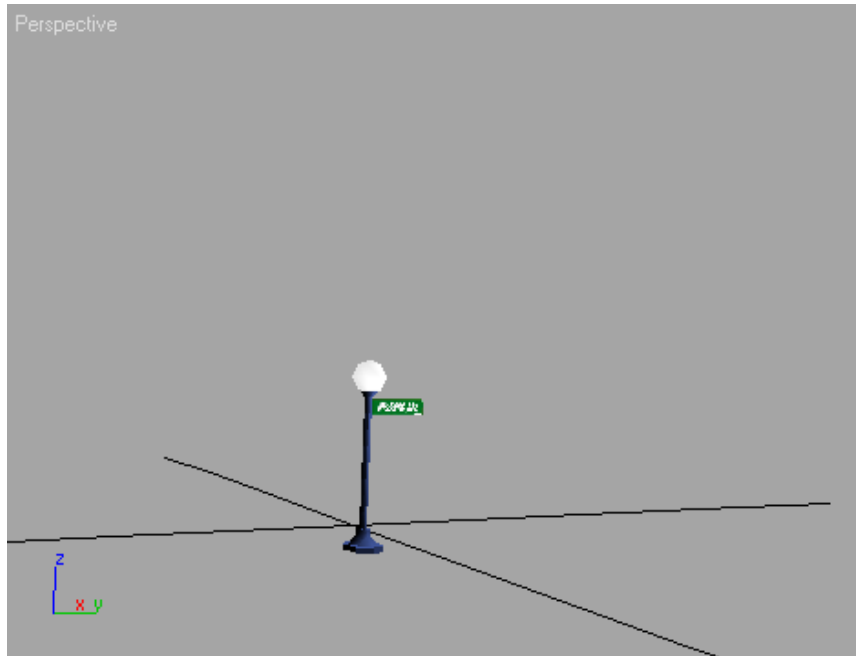

- 9 Save the lamp as **mystreetlight.max**.
- 10 Open the scene file *toonstreet.max*.
- 11 In the Perspective viewport, navigate to the street corner where you had moved the street light. Zoom in if necessary.



- 12 From the Application menu, choose References > XRef Objects.



- 13 On the XRef Objects dialog, click Create XRef Record From File, and then navigate to the `\modeling\level_design` directory, and choose *mystreetlight.max*.
- 14 On the XRef Merge dialog, choose the object *LampPostwSign*. Click OK.
- 15 Close the XRef Objects dialog.
The lamp appears on the street corner, where you had scaled it.



- 16 If you need to, right-click and choose Move from the quad menu, then move the streetlight to the corner near the yellow-and-black striped barricade.

Next, you will create a light to associate with the streetlight geometry.

Add lights:

- 1 Select the streetlight if it isn't already selected.



- 2 In the Display panel, in the Hide rollout, click Hide Unselected.



- 3 Use Zoom Extents Selected so the streetlight is clearly visible in the viewport.



- 4 On the Create panel, click the Lights button.

- 5 From the Photometric drop-down list, choose Standard.

- 6 In the Object Type rollout, click Omni, and then turn on AutoGrid.
- 7 Move your cursor over the streetlight. A creation tripod is displayed and is projected from whichever face you touch.

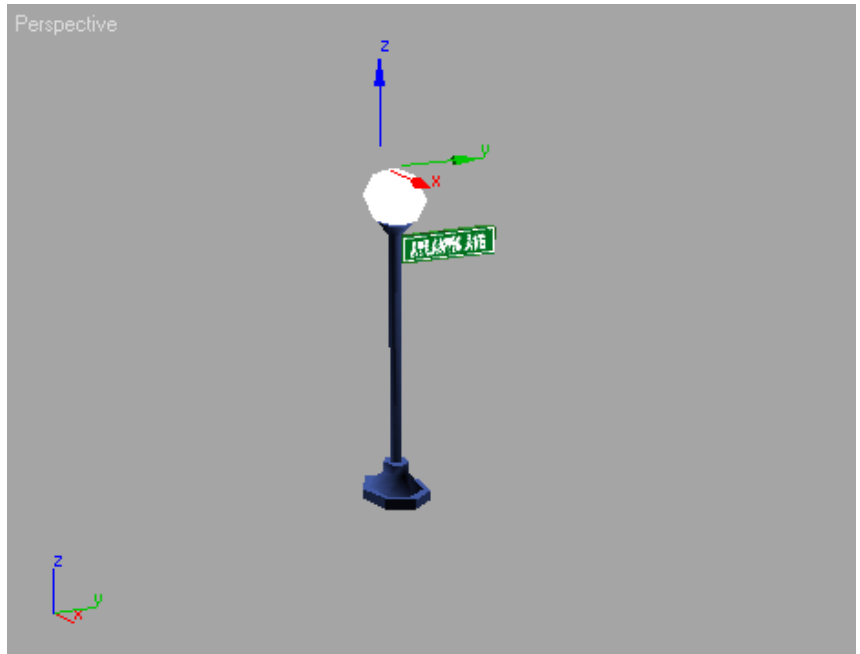

- 8 Click to create the light on the surface of the globe.
- 9 Raise the light up slightly above the globe.

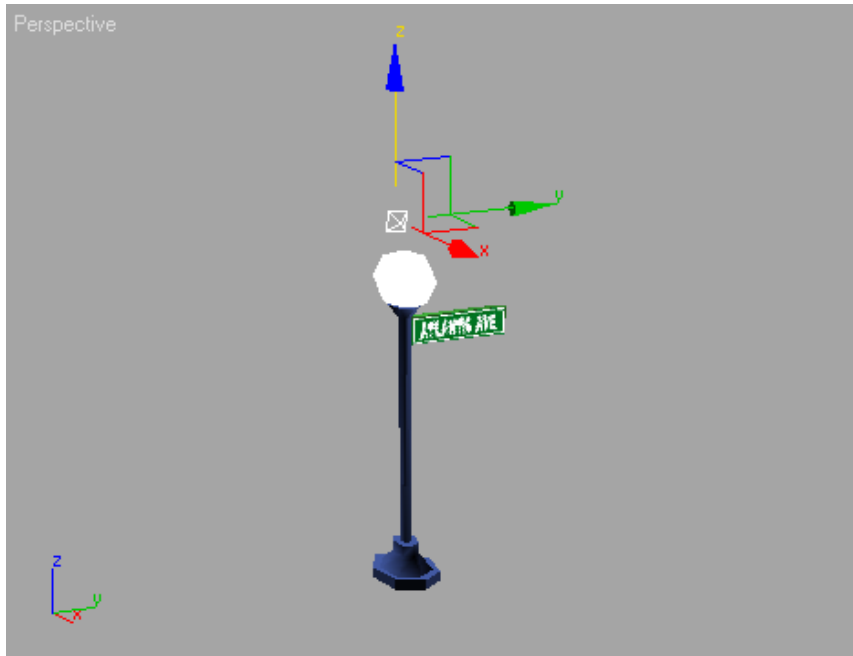

- 10 On the Modify panel, in the General Parameters rollout > Shadows group, turn on the On toggle.
- 11 On the Intensity/Color/Attenuation rollout > Decay group > Type list box, choose Inverse Square as the type of Decay.
- 12 In the Near Attenuation group, turn on Show and change Start to **20**. You can see the Decay Start Attenuation gizmo in the viewport.



- 13 On the Display panel, in the Hide rollout, click Unhide All so that you can judge the decay size in the scene geometry.



- 14 Go to the Modify panel, and turn off Show in the Intensity/Color/Attenuation rollout after you've set the Decay. (The Near Attenuation is still displayed for this light, as long as it is selected.)

Clone the lamps and lights:

- 1 Press H on the keyboard to select objects in the scene by name. Choose *Omni 01* and the *LampPostwSign* object, then close the dialog.

TIP Hold down the Ctrl key to select multiple objects in the Select By Name dialog.

- 2 On the main toolbar, in the Named Selection Sets field, name the selection **lit lamp**.

Now you can retrieve the light and the lamp in one touch.



- 3 Hold down the Shift key, then move the selection to create a clone of the lit lamp.
- 4 In the Clone Options dialog, choose Instance, so you can control all the lights by changing one.

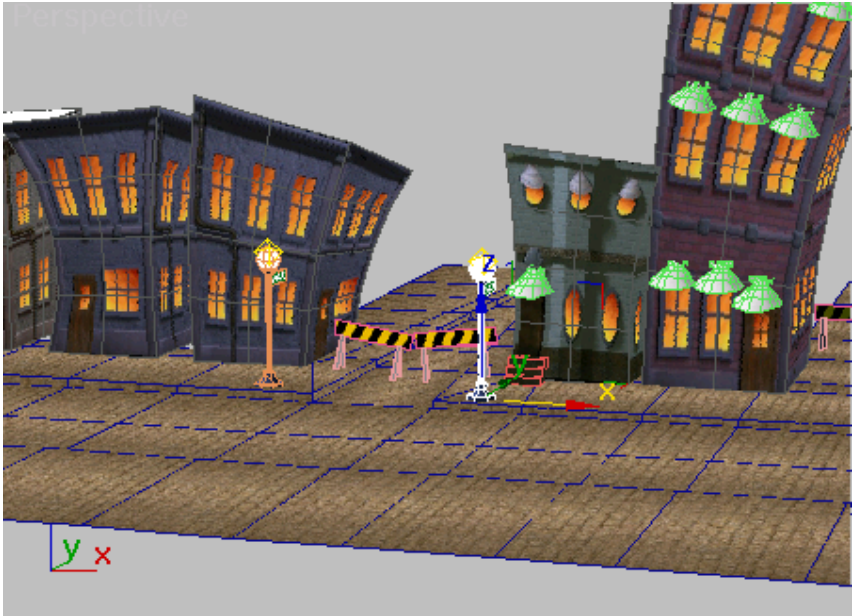

- 5 Repeat the previous two steps to add streetlights up and down both sides of the street. If performance is slow, use wireframe shading when you drag in the lamps.

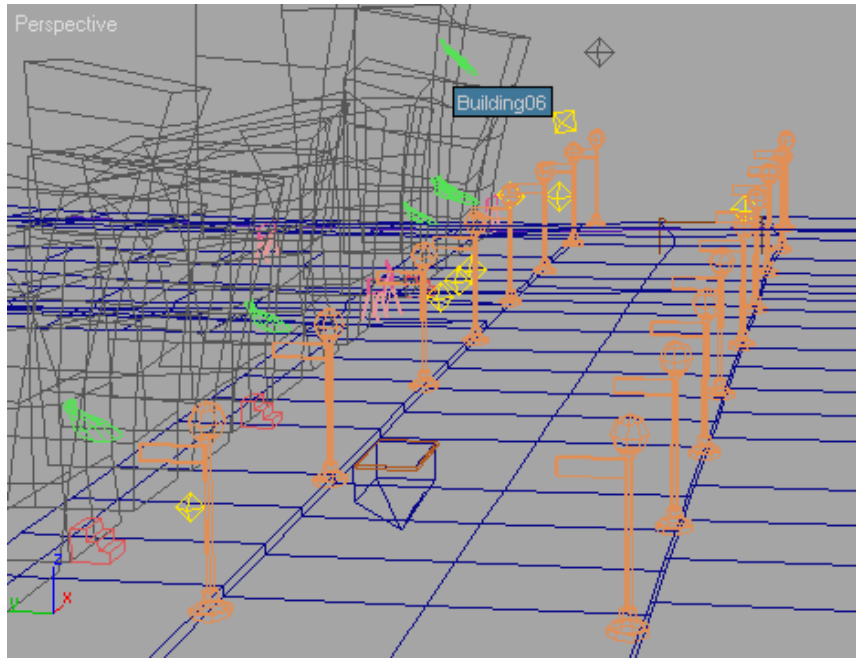

Add global lighting:

Next, you will give a little color to the Omni lights and add directional lighting.

- 1 Select the light *Omni01*.



- 2 On the Modify panel > Intensity/Color/Attenuation rollout, click the color swatch next to the Multiplier field.

A Color Selector appears.

- 3 Click an orange area in the color spectrum.

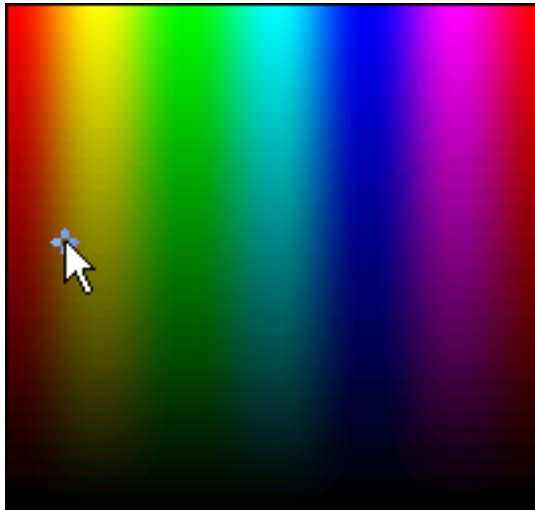

- 4 Click in the left middle of the Color Selector to choose a light orange color for the Omni light.

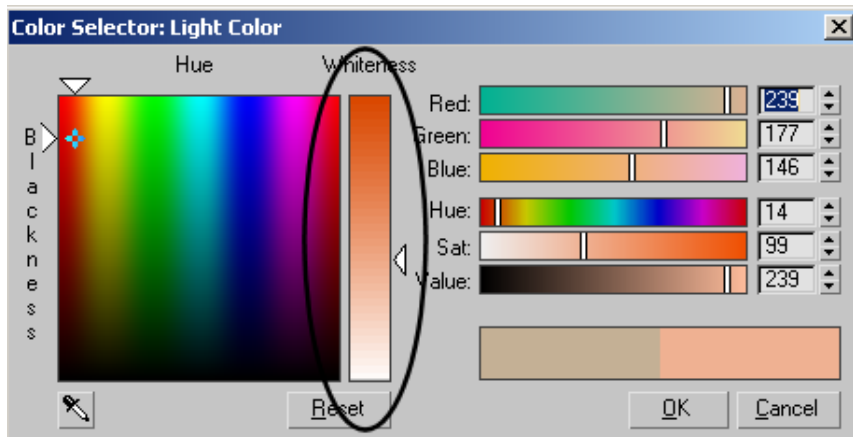

Close the dialog.

- 5 To add directional lighting to your scene, right-click the Top viewport and press Alt+W to maximize it.



- 6 On the Create Panel, click the Lights icon.

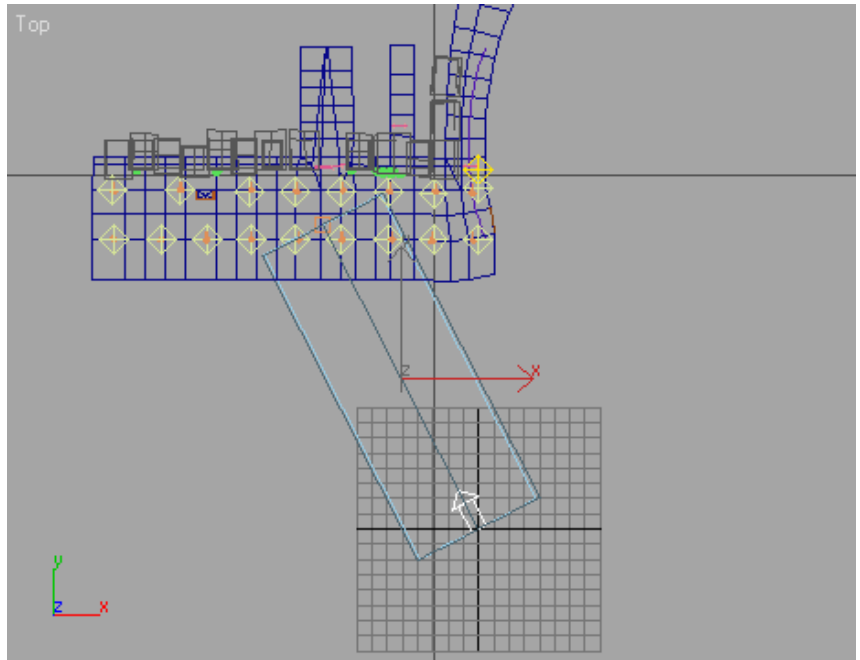

- 7 On the Object Type rollout, click Target Direct.
- 8 In the Top viewport, click and drag from the lower right of the geometry to the center of the street.

The target directional light is displayed in the viewport.

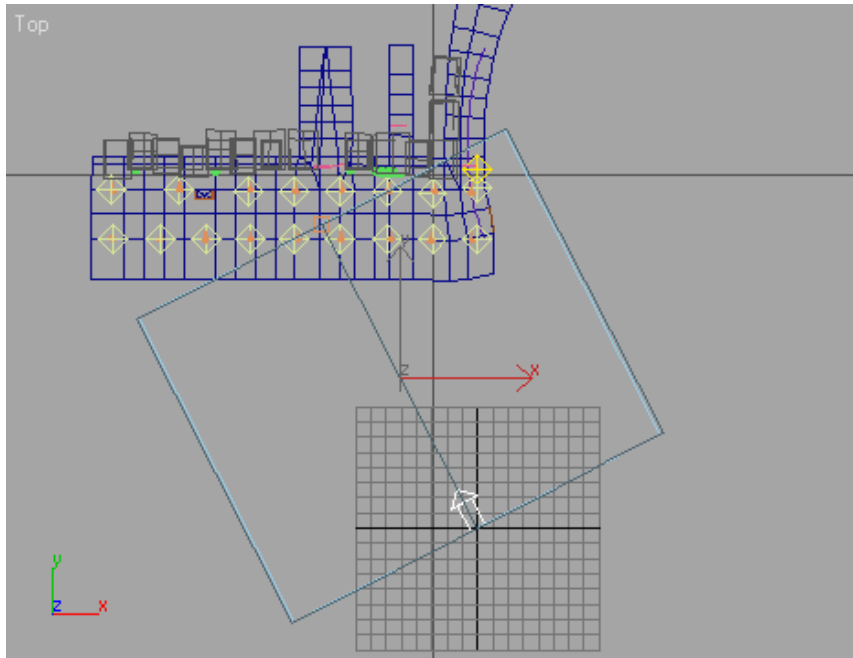

- 9 Adjust the size of the light coverage by using the Hotspot/Beam spinner in the Directional Parameters rollout. Notice that increasing the hotspot/beam automatically expands the falloff/field as well. When you decrease the hotspot/beam, the falloff/field remains unchanged.



- 10   Click the Maximize Viewport Toggle to display the four viewports again, then orbit a Perspective viewport so you can see the directional light.
- 11 Select and move the directional light to raise it up. The target stays on the street.

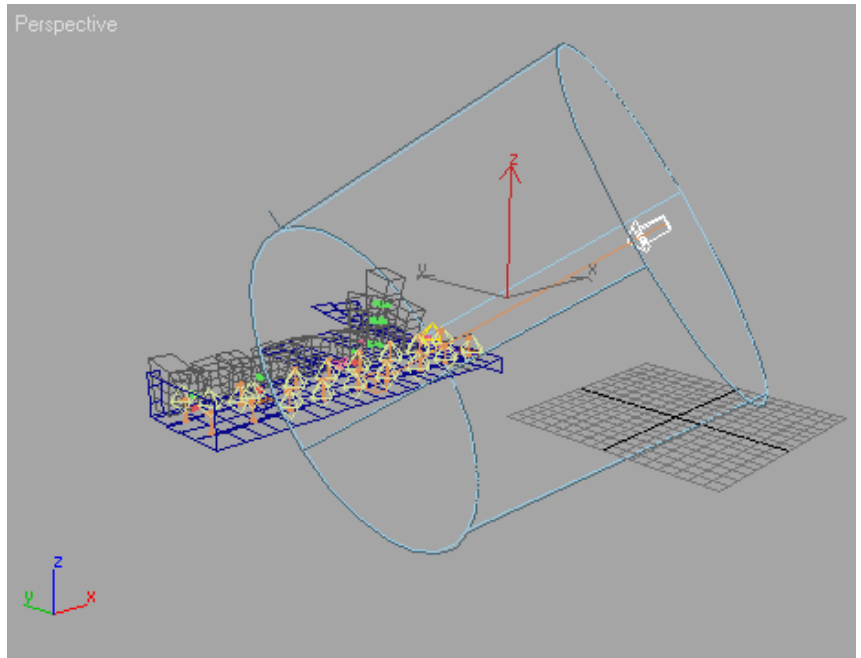

- 12  On the Modify panel, on the Intensity/Color/Attenuation rollout, click the color swatch next to the Multiplier field. In the Color Selector, choose a medium to dark blue to give the light a blue color for a moonlight setting.

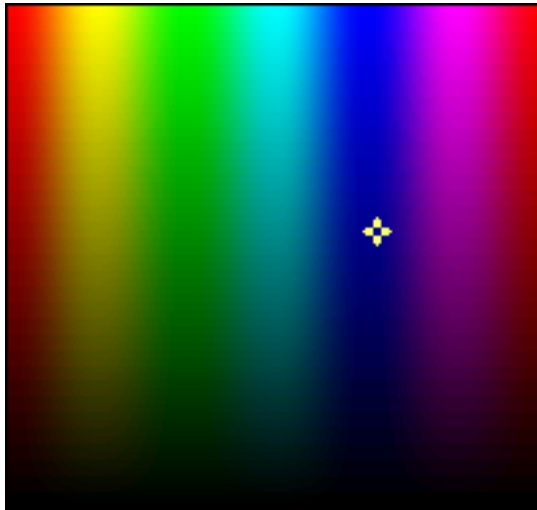

- 13 On the main toolbar, from the Selection filters drop-down list, choose Geometry. This excludes the lights from the selection operation.



- 14 In the Top viewport, drag a selection rectangle around the entire scene in the viewport. Do a Zoom Extents All out if necessary. All the geometry except for the lights is selected.
- 15 You can name this selection **Vertex Lighting** in the Named Selection Sets field on the main toolbar.

Create vertex lighting:

Here you can take the lighting information and map it into the color of the vertices.

- 1 Continue from before, or load *City_vertex_color.max* from the `\modeling\level_design` directory.
- 2 If you do choose to load the supplied scene file, choose *Vertex Lighting* from the named selection sets on the toolbar.



- 3 On the Utilities panel, click the More button, then choose Assign Vertex Colors.

- 4 If Mapping is on in the Rendering Options group, turn it off. This means to use the map's colors rather than the scene lighting.
- 5 In the Rendering Options group, turn on Shadows.
- 6 Click Assign To Selected.
3ds Max performs a series of calculations. You will observe a dialog with a progress bar flying by, rendering vertices for each of the objects in the scene. When this finishes, click an empty area of a viewport to deselect everything in the scene and see the effect of the lighting.



The scene is a little dark, so you'll make some adjustments to the lights.

- 7 Right-click the active viewport, and from the Display quadrant, choose Unhide All.
- 8 Press H and from the objects list in the Select From Scene dialog, select *Omni20* through *Omni28*. Make sure *Omni01* is not selected.
- 9 Right-click in the active viewport, and from the Display quadrant, choose Hide Selection.
- 10 Select *Omni01*.



- 11 In the Modify panel > Intensity/Color/Attenuation rollout, change the Multiplier value to **2**.
- 12 Select the *Direct01* light, and ensure that Shadows are turned on.
- 13 Choose Vertex Lighting from the named selection sets on the toolbar, and in the Modify panel > Assign Vertex Colors rollout, again click Assign. Now the scene is better lit.

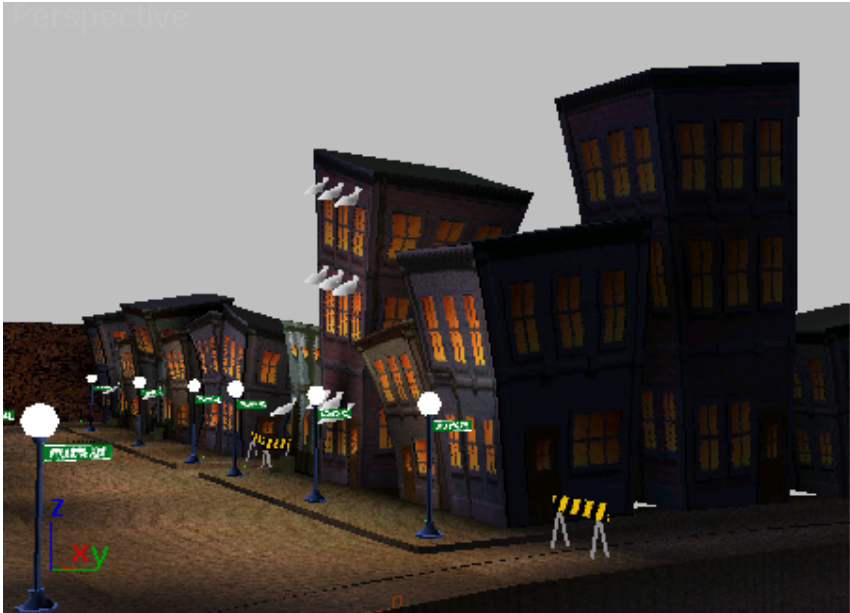

Next you'll use Vertex Paint to change some of the vertex lighting.

Painting Vertex Color in a Level

You can use Vertex Paint to change some of the vertex lighting. You'll notice a triangular dark patch near the drain. You'll paint in some more shadows to fix those hard edges.

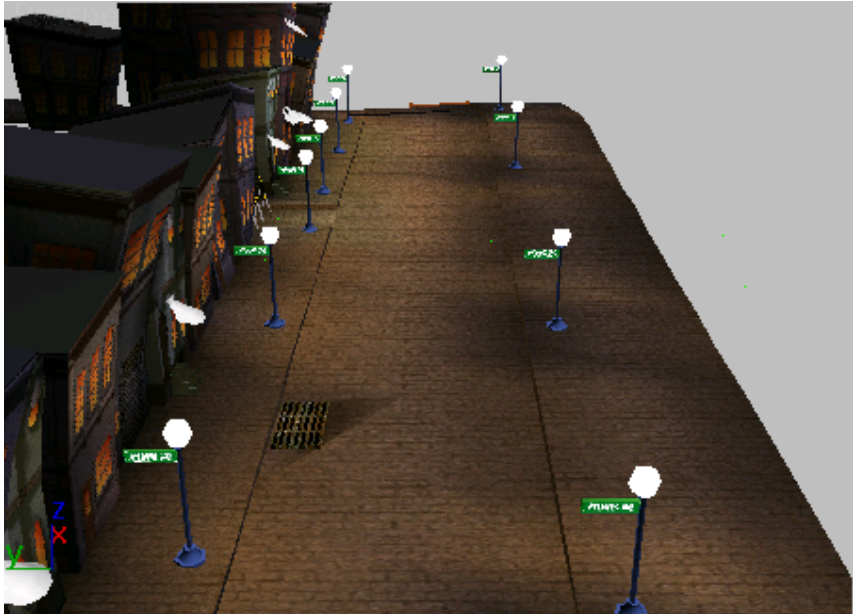

Paint vertex color in a level:

- 1 Continue from the previous lesson, or open `\modeling\level_design\city_vertex_paint.max`.



- 2 Select the *Street* object and open the Modify panel.

3ds Max opens the floating VertexPaint dialog. Here you find the tools for Vertex Painting. You will select a color to paint with, and the faces you want to paint.



- 3 Click the eyedropper button (Pick Color From Object), and then choose a dark brown color from the area near the drain. Hold the mouse down while you move the eyedropper down and move it around over the geometry. The eyedropper pick up the color from the *Street* object's map channel.



- 4 On the VertexPaint dialog, turn on Face selection, then click the face that has the hard-edged brown shadow near the drain.
The single polygon is selected in the viewport.
- 5 Use Ctrl+click to select additional faces that surround the drain.
- 6 On the VertexPaint dialog, lower the Size of the brush to 3.0

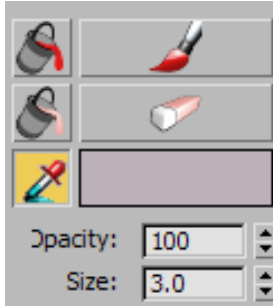

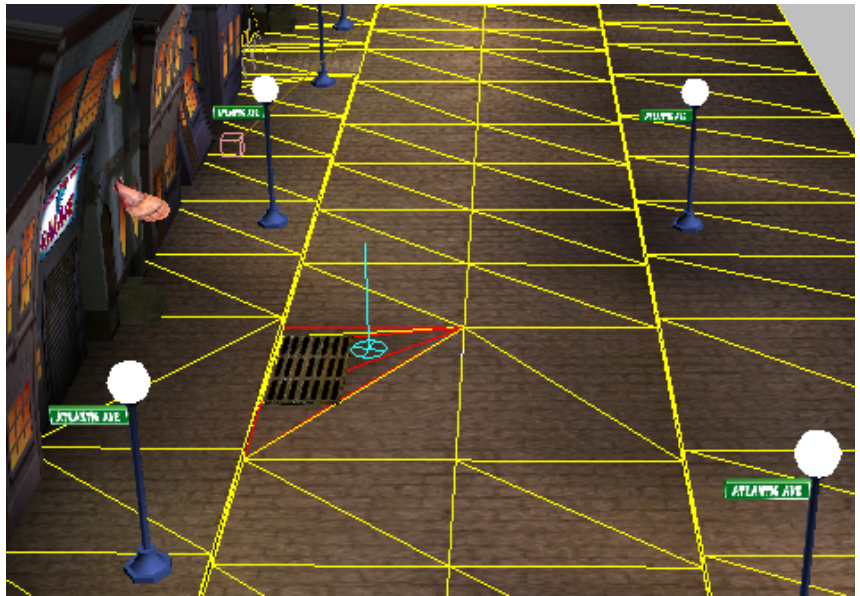

- 7 Click the Paint button, and then paint the light areas around the hard edge near the drain.



Darker color is blended near the drain to blend into surrounding sidewalk

Let's suppose you want to paint in a yellow brick road. You'll add another layer for the yellow tint.

- 8  On the VertexPaint dialog, in the Layer group click New Layer. In the dialog, click OK.
3ds Max adds another VertexPaint modifier to the stack.

- 9  Turn on Face Selection again. Hold down the Ctrl key and then in the viewport click to select polygons in the street. Add the side streets if you like.

TIP You can drag a selection rectangle to select many faces at once.

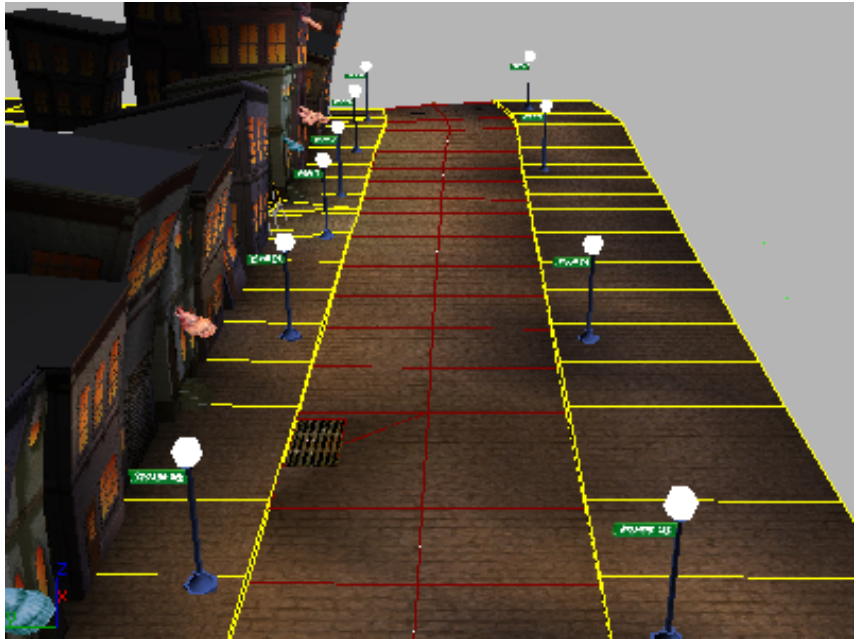

- 10 On the VertexPaint dialog, click the color swatch and then choose a yellow color from the Color Selector.



- 11 On the VertexPaint dialog, click the Paint All button.
The selection fills with yellow color.

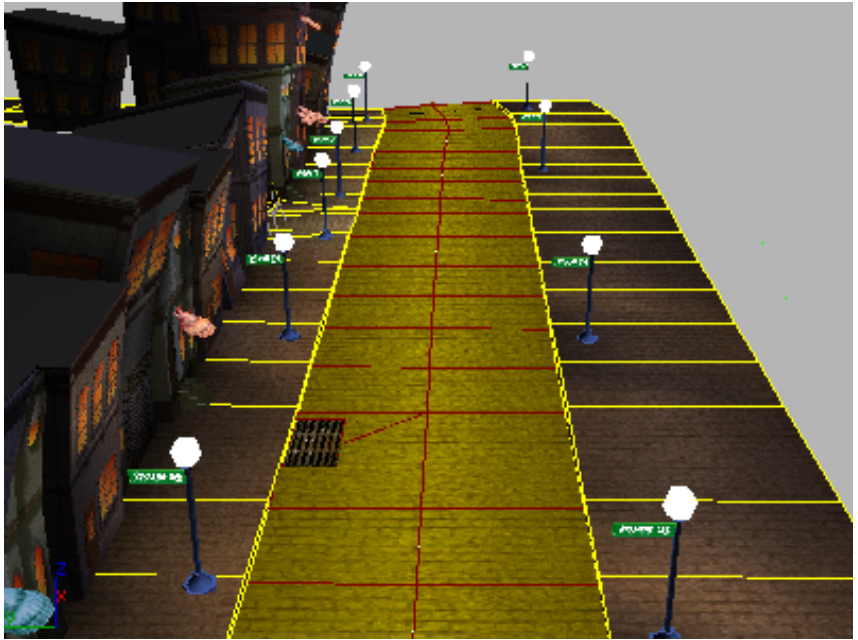

- 12 To tone down the effect, move the Opacity slider in the Layer group. Watch the paint in the viewport as you change the opacity of the layer.
- 13 For fun, click the drop-down arrow for the Mode list in the Layer group, then choose a different blending mode, such as Color Dodge, for example. See what each of the different modes does in the viewport.
- 14 Save your scene as **myyellowbrickroad.max**.

Summary

In this tutorial you modeled a city block to be used at a game level. You explored modeling with primitives and modifiers, and used XRefs to add streetlights. You also used a Blend material to create a decal on the garage and the VertexPaint modifier to paint shadows and tint the road. Finally, you used a script to paint trees into your scene.

Modeling a Helmet Using the Ribbon

The Graphite Modeling Ribbon, referred to in this tutorial simply as the “Ribbon”, is a fully customizable toolbar designed to provide you with all the tools you need to edit mesh and polygonal objects.

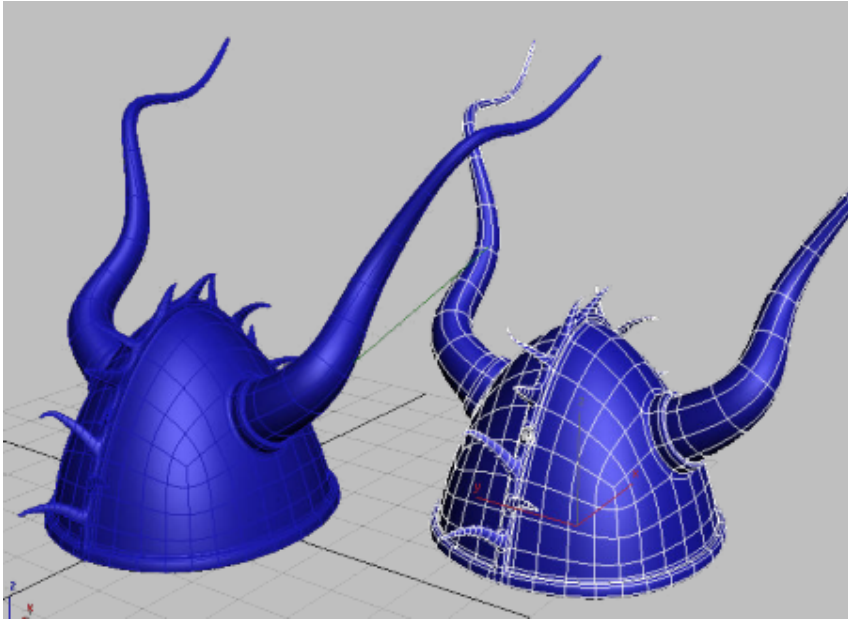

In this tutorial, you will use the Ribbon modeling tools to create a Viking helmet.

In this tutorial, you will learn how to:

- Use the Symmetry modifier to mirror edits to one side of a model.
- Create loops by connecting polygon edges.
- Extend polygons using various extrusion techniques.
- Create beveled and inset shapes.

Skill level: Intermediate

Time to complete: 1 hour

Using Basic Polygon Editing to Create a Helmet

When you model rounded objects, such as the helmet in this tutorial, we recommend that you *avoid* using a sphere as a starting point.

The next illustration shows the polygons that make up a sphere. The top of the sphere is composed of triangular polygons whose vertices tend to pinch together at the pole. This can lead to problems later on.

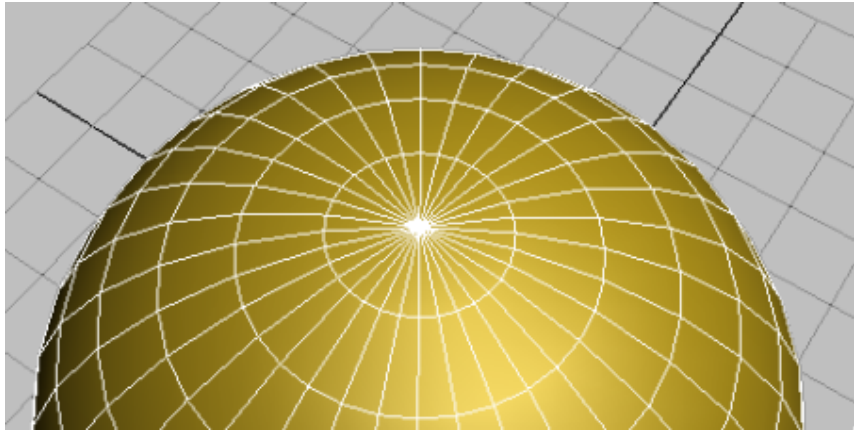

Top of sphere with vertices pinched together at its pole

It is therefore best to model a rounded object, other than an actual sphere, using rectangular polygons only. You will use this technique in this lesson.

Create the basic helmet shape:

- 1 Start 3ds Max.

By default, a minimized version of the Graphite Modeling Tools Ribbon displays directly below the main toolbar.

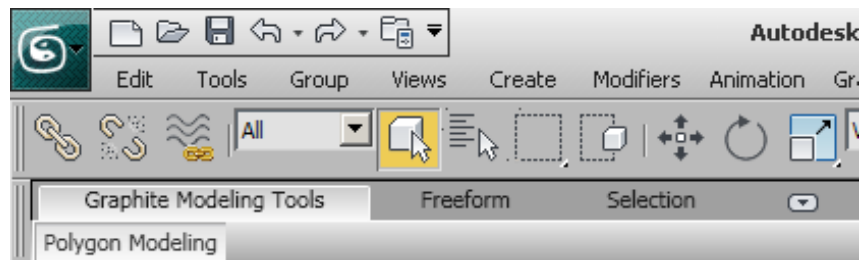

NOTE The Ribbon on your workstation might display differently if you customized the Ribbon was customized in previous 3ds Max work sessions. This tutorial assumes you are using the default configuration.

- 2 Click the expand/minimize icon a few times until the full Ribbon displays.

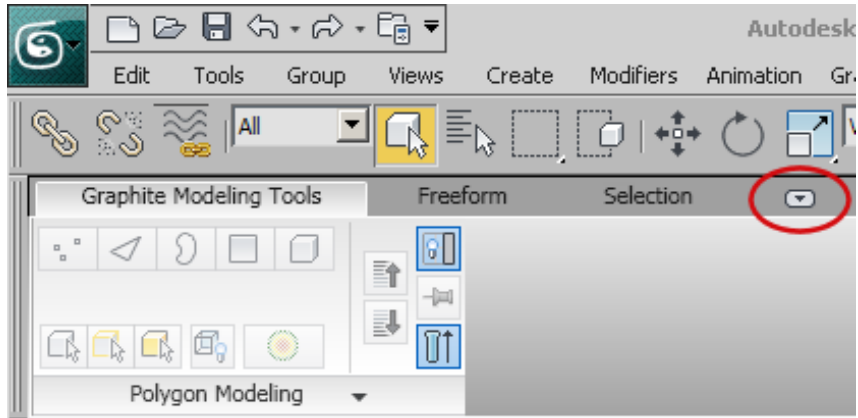

The tools in the Polygon Modeling tab are inactive, since no polygon model exists in the scene.

- 3 From the Customize menu, choose Units Setup, and in the Units Setup dialog > Display Unit Scale group, make sure Generic Units is on.

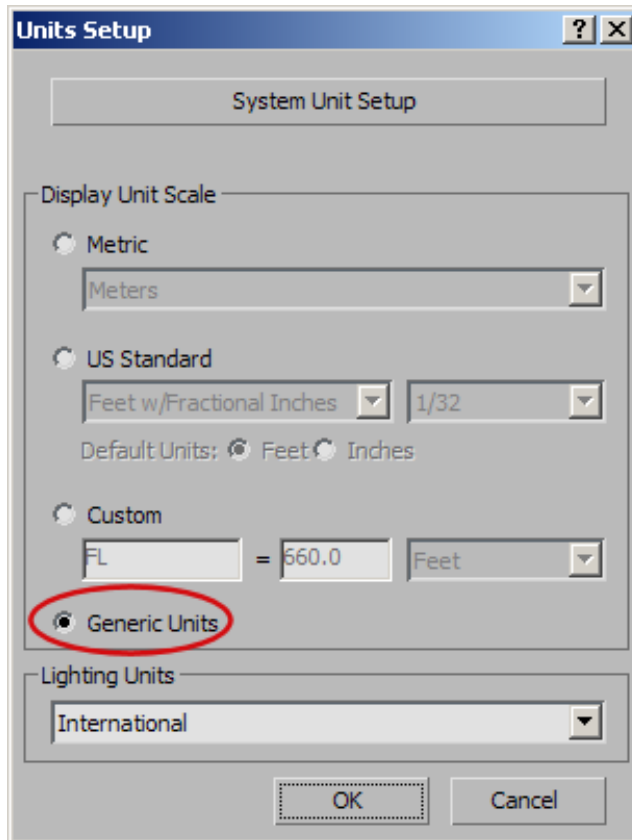

- 4 Activate the Perspective viewport, press Alt+W to maximize it, then click the Shading viewport label menu and choose Edged Faces. After this choice, the Shading viewport label should show "Smooth+Highlights+Edged Faces."



- 5 On the Create panel > Object Type rollout, click Box.
- 6 Drag to create a box of any size.
- 7 On the Modify panel > Parameters rollout, set Length, Width, and Height to **50.0**.

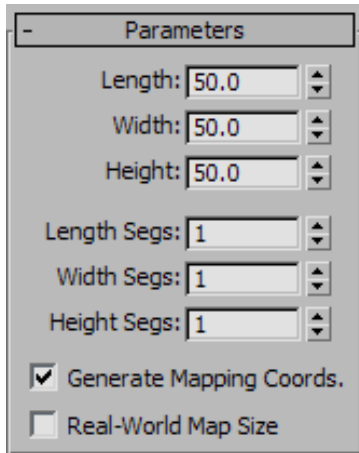

Currently, the pivot point is at the base of the object. You need to set this point to the center of the box so you can manipulate the object more easily.

- 8  In the Hierarchy panel > Adjust Pivot rollout > Move/Rotate/Scale group, click **Affect Pivot Only** to turn it on.

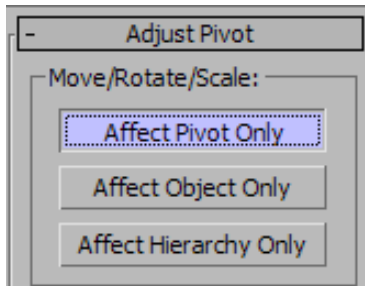

- 9 In the Alignment group, click **Center To Object**, then click **Affect Pivot Only** again to turn it off.

- 10  On the main toolbar, click **Rotate** and rotate the box. The box now rotates around the object's center of mass.

- 11  Undo the rotation.



12 Right-click the box, and choose Transform > Move.

13 Right click the X, Y, and Z transform spinners to set each of them to **0.0**.

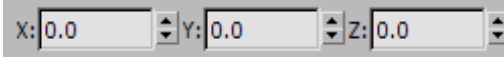

The center of the box is now at the center of the world coordinates.



14 On the Modify panel > Parameters rollout, set Length Segs, Width Segs, and Height Segs to **4**.

15 From the Modifier list, choose Spherify.

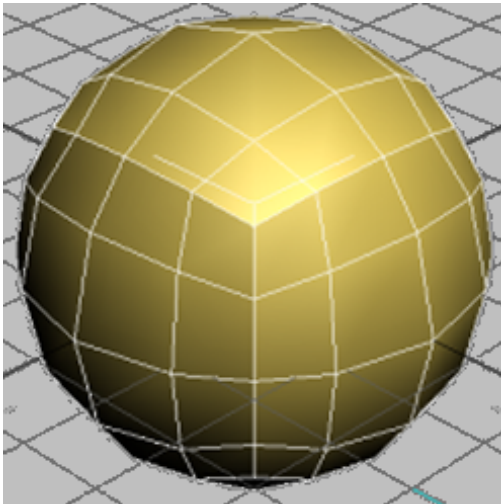
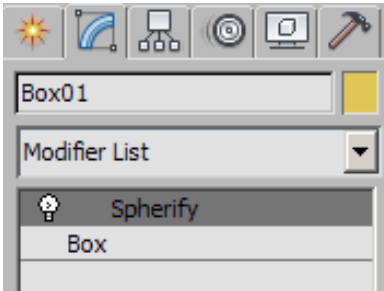

Box with Spherify modifier applied

The object is deformed into a spherical shape, but retains its geometric composition of easily editable quadrilateral polygons.

You only need a hemisphere to create the helmet, so next you will delete the lower half of the box and deform the remaining polygons into a conical shape.

Refine the shape:

- 1 In the viewport, right-click the sphere and choose Convert To > Convert To Editable Poly.

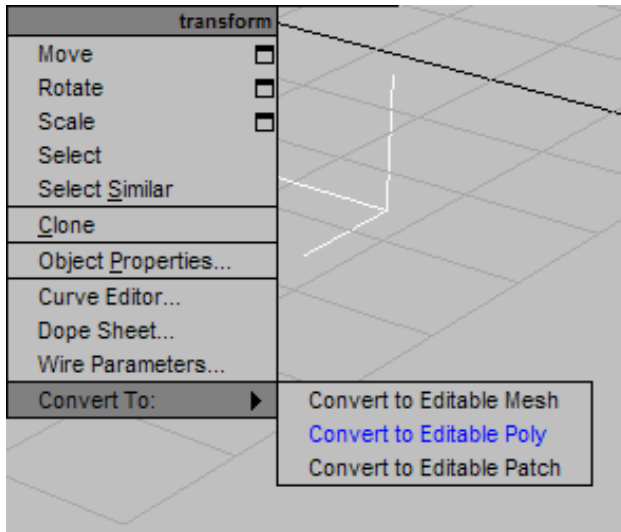

The Ribbon updates to display a range of polygon-editing tools.

- 2  Orbit the viewport until the vertices on the lower half of the box are clearly visible.
- 3 On the Ribbon > Polygon Modeling panel, activate Vertex selection mode, region-select all the vertices in the lower half of the object, then press Delete.

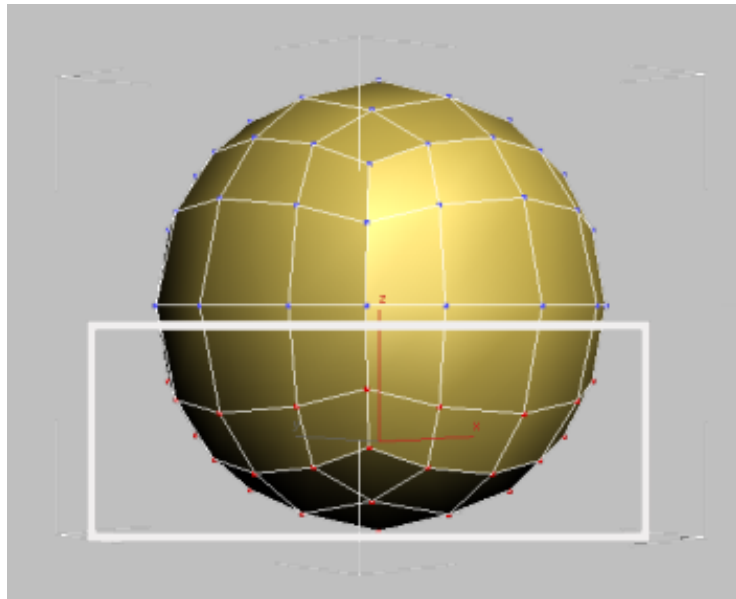
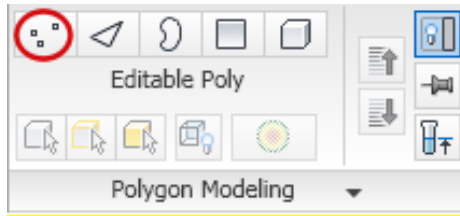

You now have a hemispherical dome for the helmet. Next, you will give the object a slightly conical shape.



- 4 Select the vertex at the top of the helmet and drag upward on its Z axis.

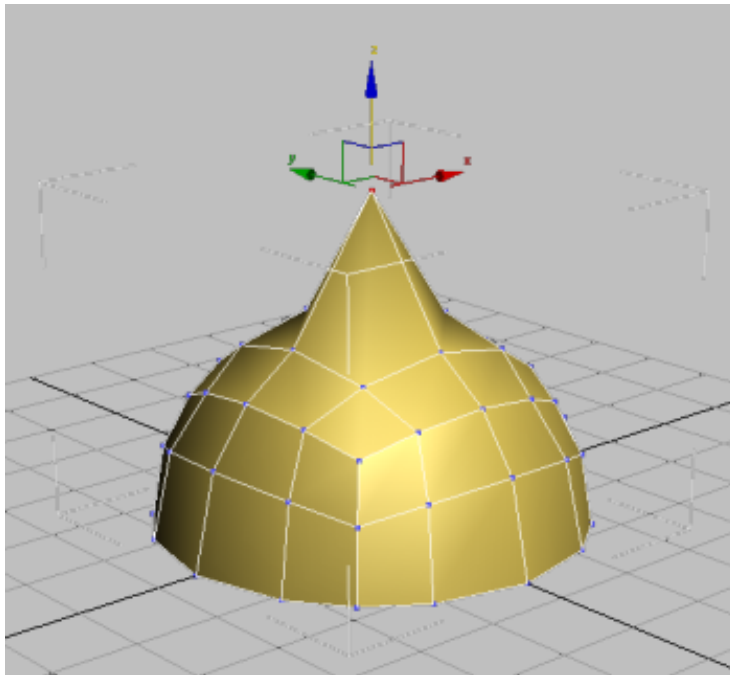

Top vertex after transformation in Z

Notice that only the polygons that share the vertex are deformed. You need to use Soft Selection to involve the adjacent vertices and polygons as well.



5 Undo the vertex move.

6 On the Ribbon Polygon Modeling panel, click Soft Selection to turn it on.

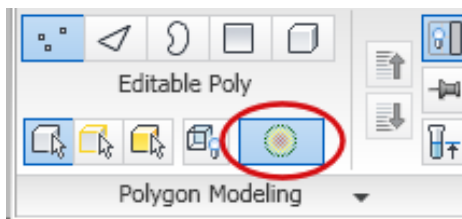

A Soft Selection panel displays at the end of the Ribbon to the right, providing you with options that control how the soft selection is carried out.

- 7 On the Soft Selection drop-down panel, set Falloff to **30.0**.

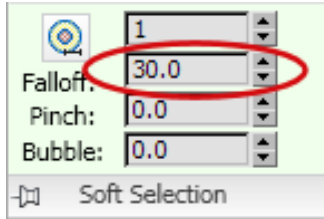

- 8 Drag the top vertex of the helmet on its Z axis again, until the object appears similar to that in the next illustration.

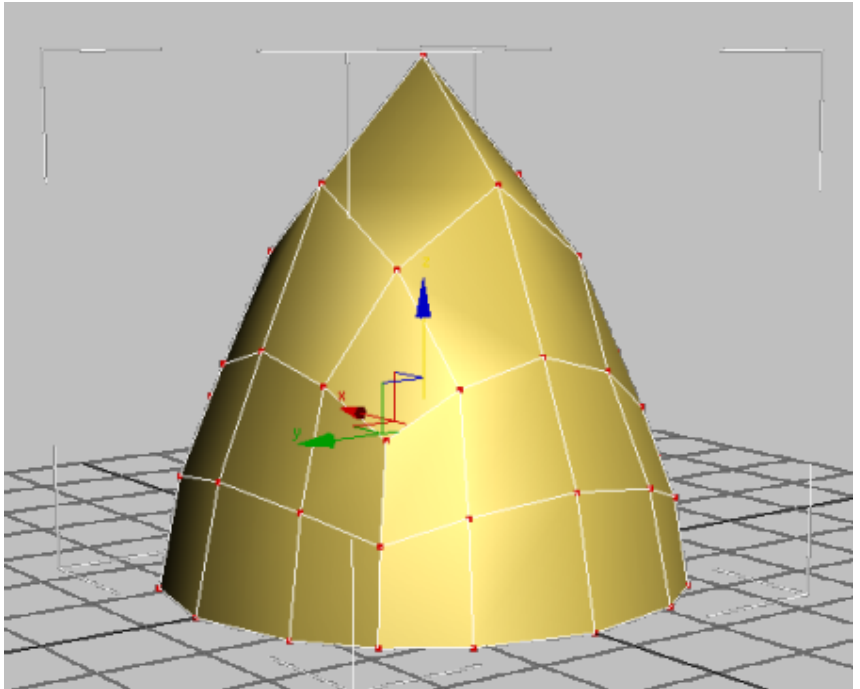

- 9 On the Ribbon > Polygon Modeling panel, click Soft Selection again to exit this selection mode.

Next, you will use the MeshSmooth tools to smooth out the helmet surface.

- 10 In the viewport, drag to select all the object vertices (or press Ctrl+A), and then on the Ribbon > Subdivision panel, click MSmooth.

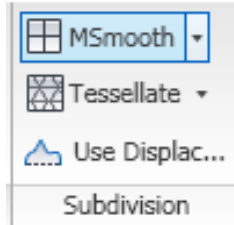

This option takes each polygon and divides it into four, making a smoother, more detailed geometry.

- 11 On the Ribbon > Polygon Modeling panel, click Vertex to exit this selection mode.
- 12 Save your scene as **my_helmet_01.max**.

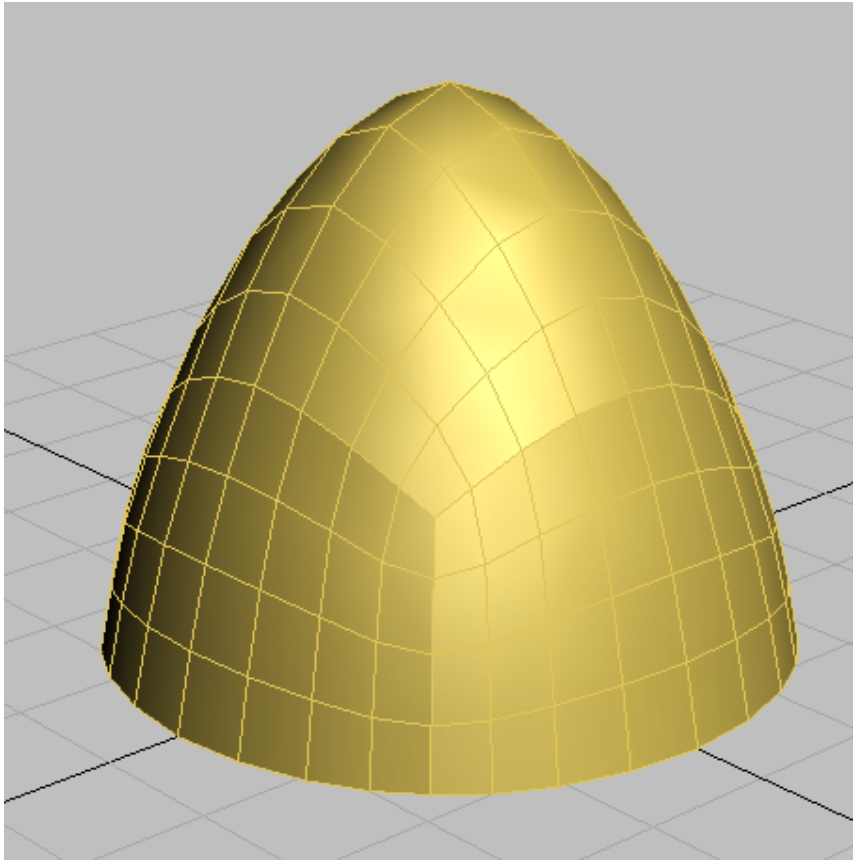

Working In Symmetry Mode to Add Detail to the Helmet

In this lesson, you will work in symmetry mode on half the helmet. This way, any changes you make will be perfectly mirrored for the other half.

Add the Symmetry Modifier:

- 1 Continue from the previous lesson, or open the scene file called *helmet_01.max*. This scene is in the folder `\scenes\modeling\helmet\`.
- 2 If you are starting this lesson from *helmet_01.max*, on the Ribbon > Polygon Modeling panel, click Modify Mode.

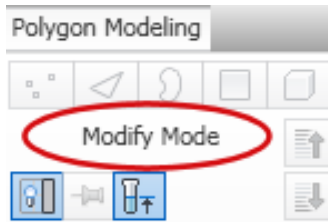

When active, Modify Mode makes the entire array of Graphite Modeling Tools available.

- 3 On the Polygon Modeling panel, activate Polygon selection mode.

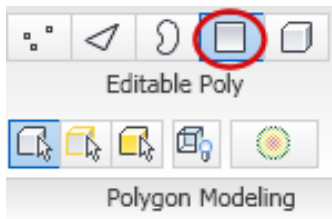

- 4 Click the Ribbon's Selection tab.



- 5 On the By Half panel, click Y, then click the Selection button.

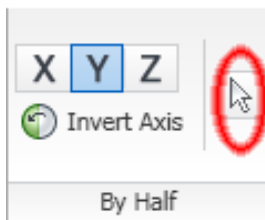

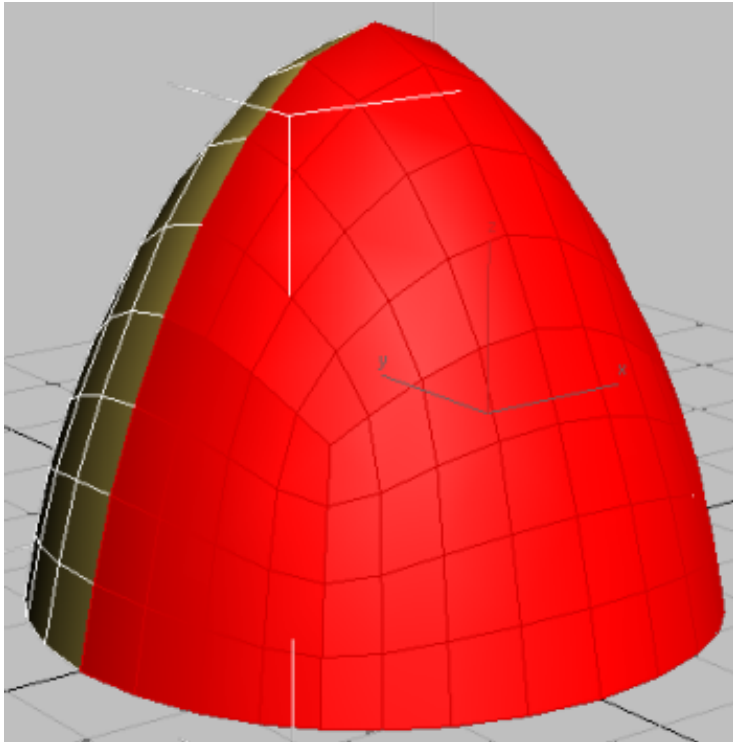

This selects half the object based on its Y axis orientation.

- 6 Click Invert Axis.

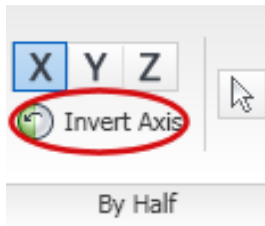

The polygon selection is inverted. These are the polygons you want to remove.

- 7 Press Delete.
You will now add a Symmetry modifier to these polygons so that their geometry can be mirrored.

- 8  On the Ribbon, click the Graphite Modeling Tools tab, and with the helmet object still selected, go to the Modify panel and from the Modifier List choose Symmetry.
- 9 On the Parameters rollout > Mirror Axis group, choose the Y option and turn on Flip.

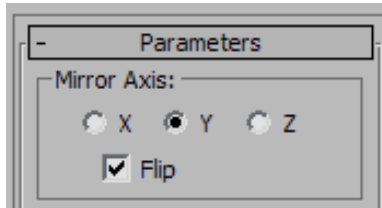

This properly orients the mirrored half of the helmet.

Notice how the Ribbon displays a limited set of modeling tools. This is because the Symmetry modifier is active.

- 10 On the Ribbon > Polygon Modeling panel, click the Previous Modifier button.

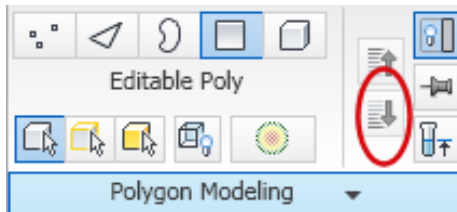

The Editable Poly modifier is now active and the Ribbon displays an expanded set of tools for polygon editing.

The mirrored half of the helmet is hidden in the viewport because with the polygon editing controls displayed, you are editing the source polygons only.

- 11 On the Polygon Modeling panel, click Show End Result to see mirrored side of the helmet controlled by the Symmetry modifier.

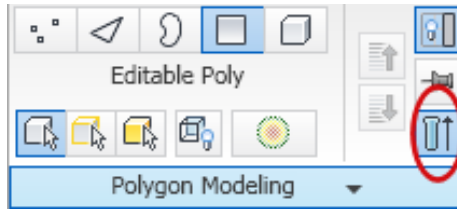

- 12 Click Show End Result again to exit this mode.

Preview mesh smoothing:

- 1 On the Edit panel, click the Use NURMS tool.

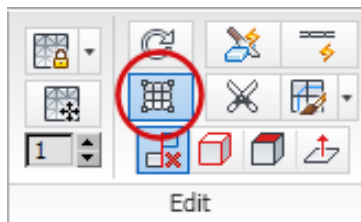

The Use NURMS panel displays at the right of the Ribbon. (NURMS is short for Non-Uniform Rational MeshSmooth.)

- 2 On the Use NURMS panel, set Iterations to **2**.
This smooths out the object by adding more polygons to the geometry. It is best to specify an Iterations value of no more than 3, because each time you increase iterations by one, the number of vertices and polygon faces can increase by a factor of four. This can result in a lengthy calculation time.
- 3 If the Show Cage button is already on, turn it off to better see the geometry added by the NURMS iterations.

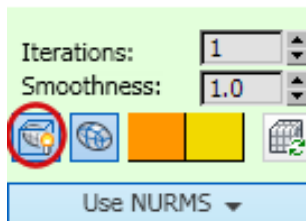

Next, you will add two extrusions that will form the rim of the helmet and its vertical seam.

Select the seam and rim faces to extrude:

- 1 On the Ribbon > Edit panel click Use NURMS to turn it off.
- 2 On the Polygon Modeling panel, activate Edge selection mode.

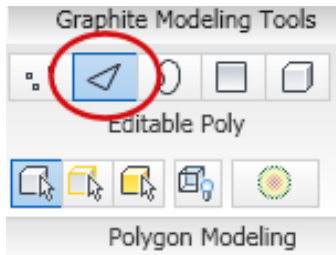

- 3 In the viewport, select a polygon edge as shown in the next illustration, and on the Modify Selection panel, click Ring.

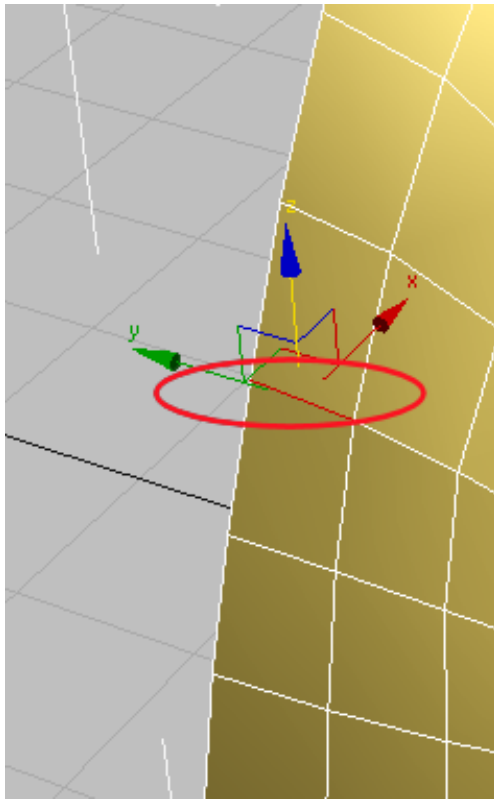

All edges parallel to the first one in a ring around the object are selected.

- 4 On the Loops panel, Shift+click Connect.

A single loop is drawn around the selected edges. By default, the loop is placed in the center of the selected edges, but the negative Slide value you will specify in the next step will position it to the left of center.

- 5 On the Connect Edges dialog, set Slide to **-50.0**, and click OK.

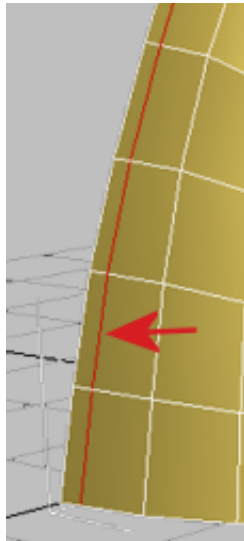
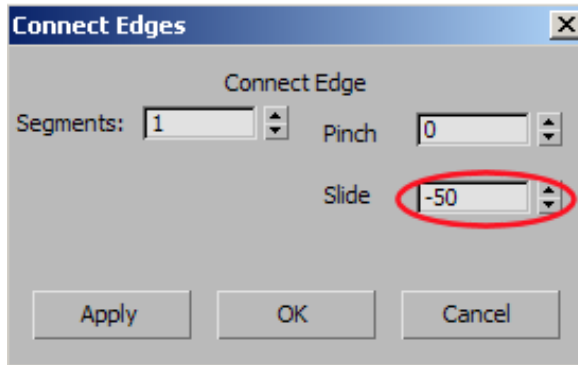

Edge slides to the left

- 6 In the viewport, click a vertical edge on any polygon at the bottom row of the helmet and on the Ribbon > Modify Selection panel, click the Ring tool.

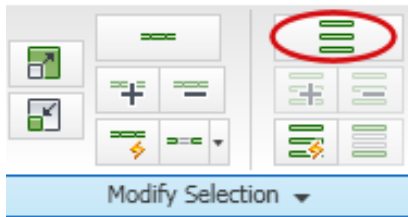

The Ring tool automatically selects all the vertical edges.

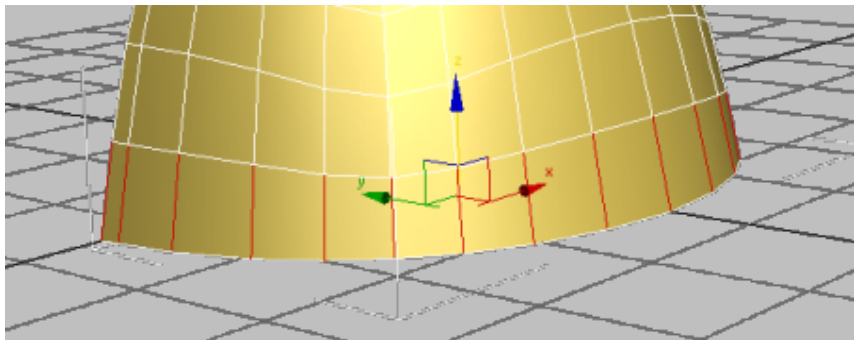

- 7 On the Loops panel, Shift+click the Connect tool.

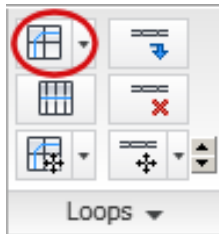

- 8 On the Connect Edges dialog, set Slide to **-25.0** and click OK.
- 9 On the Polygon Modeling panel, click Show End Result to see how the Symmetry modifier has added a mirrored portion to the helmet.
- 10 Right-click the helmet and choose Transform > Convert To > Convert To Editable Poly.

The Symmetry modifier is removed and all the mirrored polygons are integrated into the model.

- 11 On the Ribbon > Polygon Modeling panel, activate Edge selection mode.
- 12 On the Modify Selection panel, click Loop Mode to turn it on.

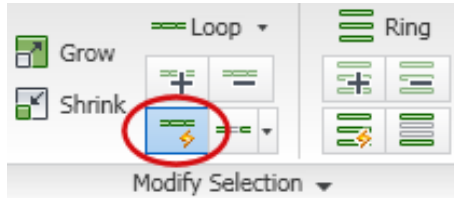

- 13 Click an edge along the center edge of the helmet.

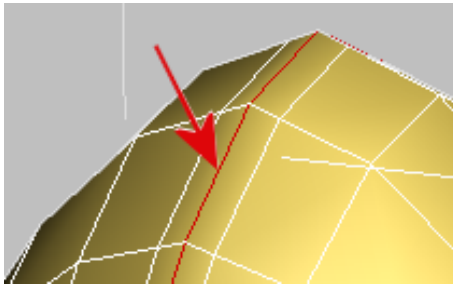

With Loop Mode on, 3ds Max selects all center edges.

- 14 With Loop Mode still active, hold down Ctrl, then click an edge along the bottom edge of the helmet.

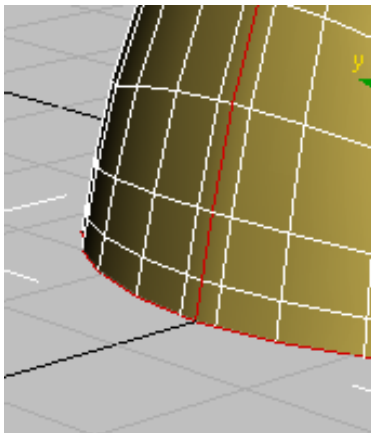

- 15 Hold down Ctrl and on the Ribbon > Polygon Modeling panel, activate Polygon selection mode.
All polygons connected to the selected edges are now selected.

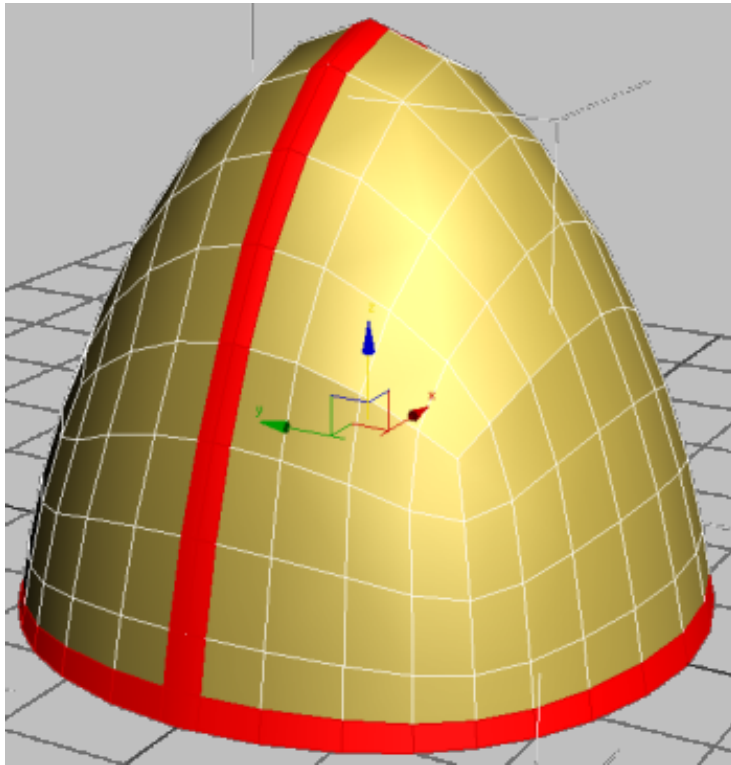

Extrude the helmet seam and rim:

- 1 On the Polygons panel, Shift+click Extrude.

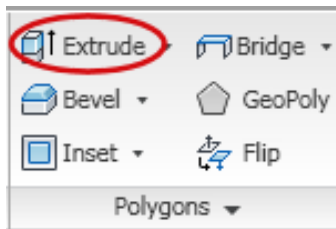

- 2 On the Extrude Polygons dialog > Extrusion Type group, choose Local Normal.

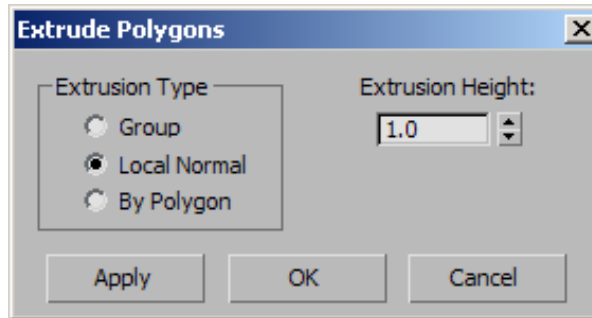

- 3 Set Extrusion Height to **1.0** , then click OK.
- 4 On the Ribbon > Polygon Modeling panel, click Polygon selection to exit sub object mode.
- 5 On the Edit panel, click Use NURMS and on the Use NURMS panel, click the Show Cage button to hide the cage, then press F4 to view the end result.

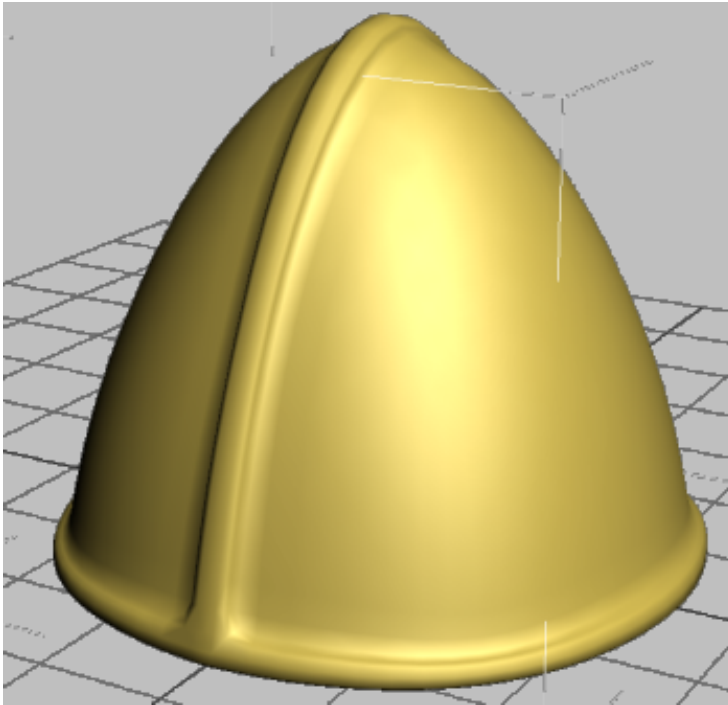

Helmet with middle seam and rim extrusions

- 6 On the Use NURMS panel, set iterations to **2** to further smooth out the helmet.
In the next few steps, you will add more edges to create a less rounded extrusion to the helmet rim and middle seam.
- 7 Save your scene as **my_helmet_02.max**.

Refine the extrusion:

- 1 Continue working on your scene, or open the scene file called *helmet_02.max*
- 2  Select the helmet, make sure the Modify panel is active, and on the Ribbon > Edit panel, click Use NURMS to turn off NURMS mode.
- 3 In the viewport, switch to Left Wireframe view.

Notice the slight wave to the extruded rim of the helmet.

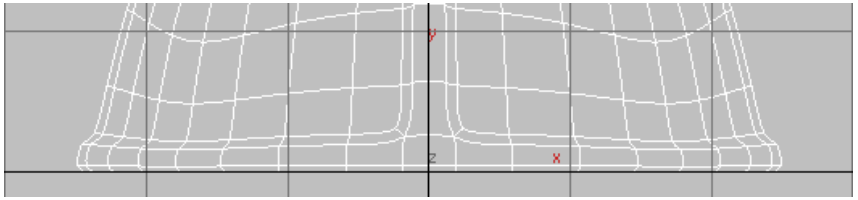

- 4 On the Ribbon > Polygon Modeling panel, activate Vertex selection mode, then region-select the second-from-bottom two rows of vertices.

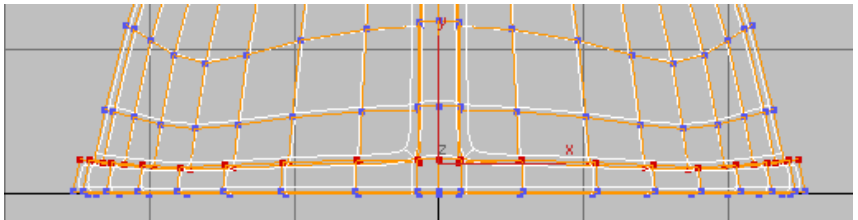

- 5 On the Align panel, click Z to align all the vertices along their average orientation on the Z axis.
- 6 Switch to Top view and region-select the vertices on one side of the seam extrusion.

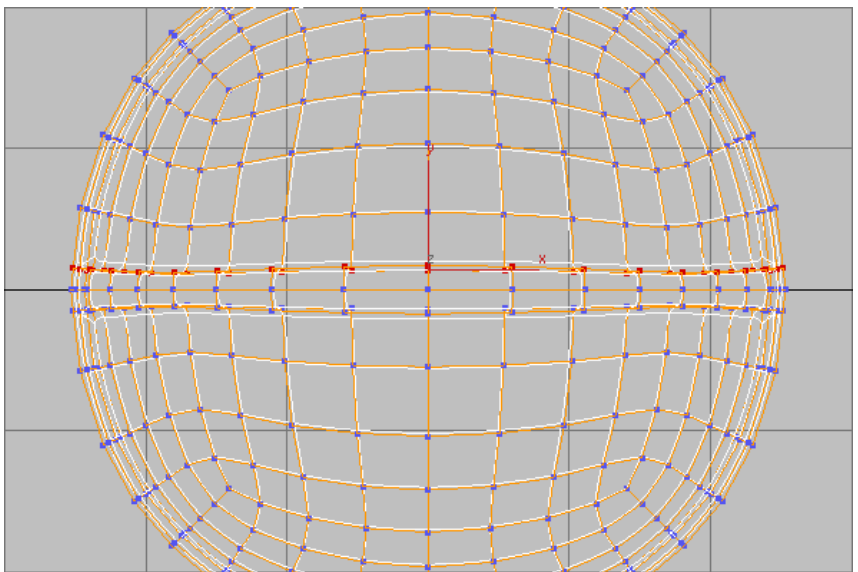

- 7 On the Ribbon > Align panel, click Y to align all the vertices along their average orientation on the Y axis.

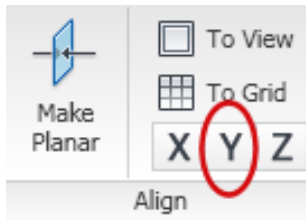

- 8 Region-select the vertices on the opposite side of the seam extrusion, and repeat step 7.
- 9 Change the viewport to Perspective view once again.
- 10 On the Ribbon > Polygon Modeling panel, activate Edge selection mode.
- 11 Click a polygon edge as shown in the next illustration. On the Modify Selection panel, click the Ring tool, then click a polygon edge as shown in the next illustration.

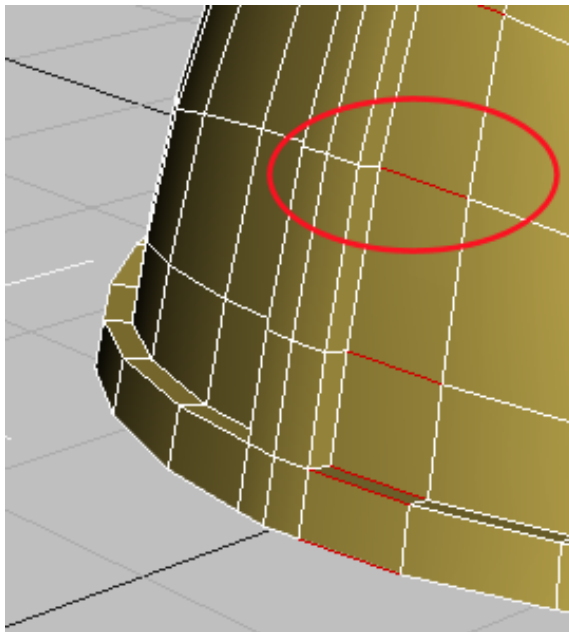

All edges parallel to the one you selected are also selected automatically.

- 12 On the Loops panel, Shift+click Connect and on the Connect Edges dialog, set the Slide value to **83.0**. Click OK.

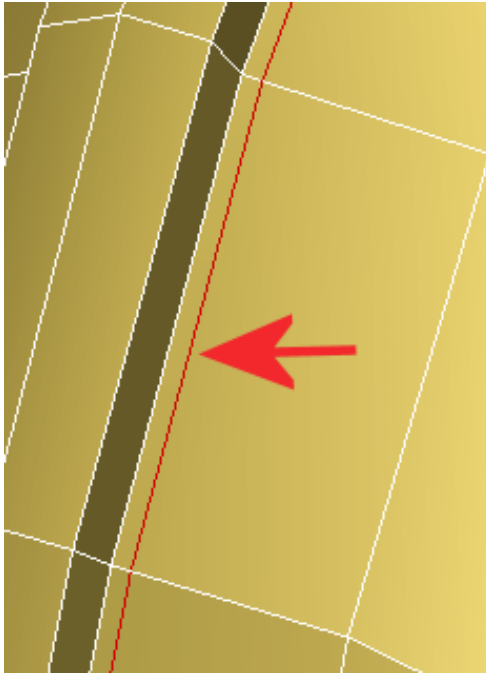

Loop slides to the left

- 13 Rotate the helmet object so that the opposite side of the vertical seam is clearly visible. On the Edit panel, click the Swift Loop tool.



A green virtual loop appears as you drag the mouse over the helmet. It lets you visualize where to place the loop.



- 14 Click to place the loop. It should be equally distant from the extrusion as the loop on the other side of the extruded seam.

3ds Max automatically creates a loop perpendicular to the selection point. This method is a fast way to create and position a loop on a model.

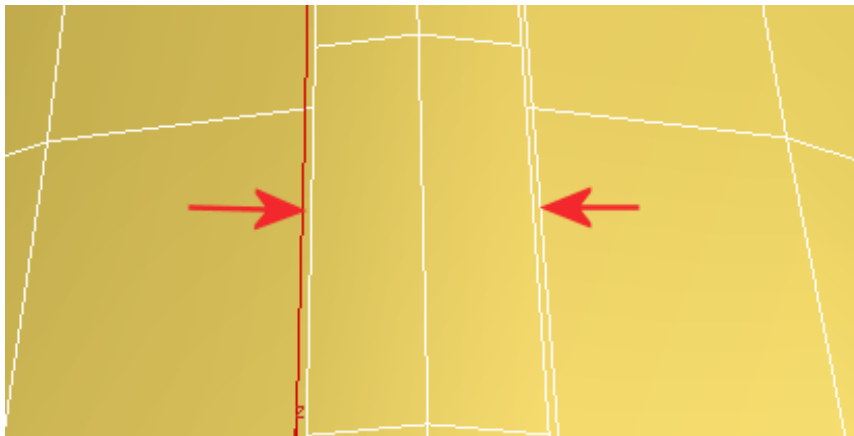

- 15 Position your cursor over a polygon edge just above the helmet rim, using the green virtual loop to visualize the loop placement, then click to create the loop.

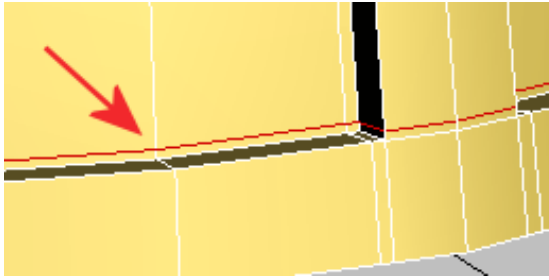

- 16 Click the Swift Loop tool to deactivate it.
- 17 On the Ribbon > Edit panel, click Use NURMS to activate it, then press F4 to turn off edged faces and see how the added loops give the extrusion joint a sharper angle.

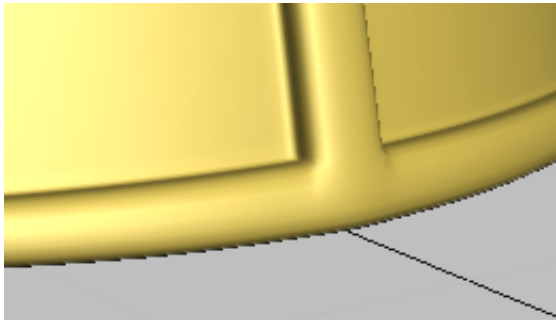

Helmet detail, showing sharper extrusions

- 18 Press F4 again and click Use NURMS to turn it off and redisplay the underlying model.
- 19 Save your scene file as **my_helmet_03**.

Using Extrusions to Add Horns to the Helmet

This lesson shows you how to create a pair of twisting horns. It uses extrusions and transforms; it also demonstrates spline extrusion as a simple alternative to multiple extrusions.

You will continue to apply the Symmetry modifier to the model to mirror the edits you make to one half of the helmet.

Use extrusion and bevel to create the socket for the horn:

- 1 Continue working from the previous lesson, or open *helmet_03.max*.
- 2 Repeat steps 1 to 11 from the procedure called Add the Symmetry Modifier in the previous lesson to add the modifier to the helmet.
- 3 On the Ribbon > Polygon Modeling panel, activate Vertex selection mode and on the Geometry panel, make sure Use NURMS is deactivated.
- 4 On the Edit panel > Constraints group, click the Constrain To Edge tool.

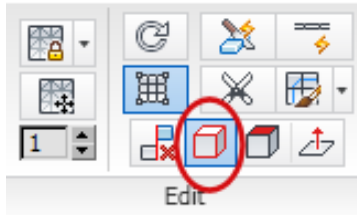

This ensures that the transform of any vertex will slide along the edges of the polygon to which it belongs.



- 5 On the main toolbar, click Select And Move, then select a vertex in the upper region of the helmet and translate it as shown in the next illustration.

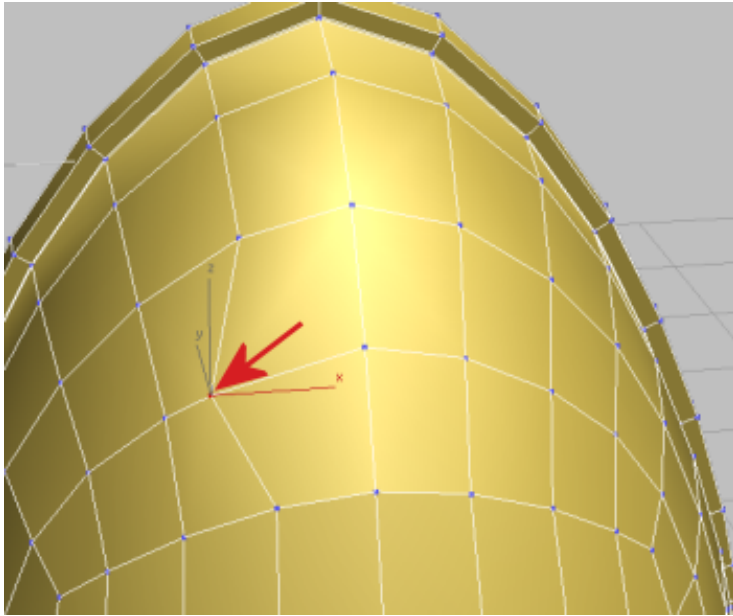

- 6 Select the adjacent vertices and translate them as well, until you have a symmetrical shape that is roughly circular.

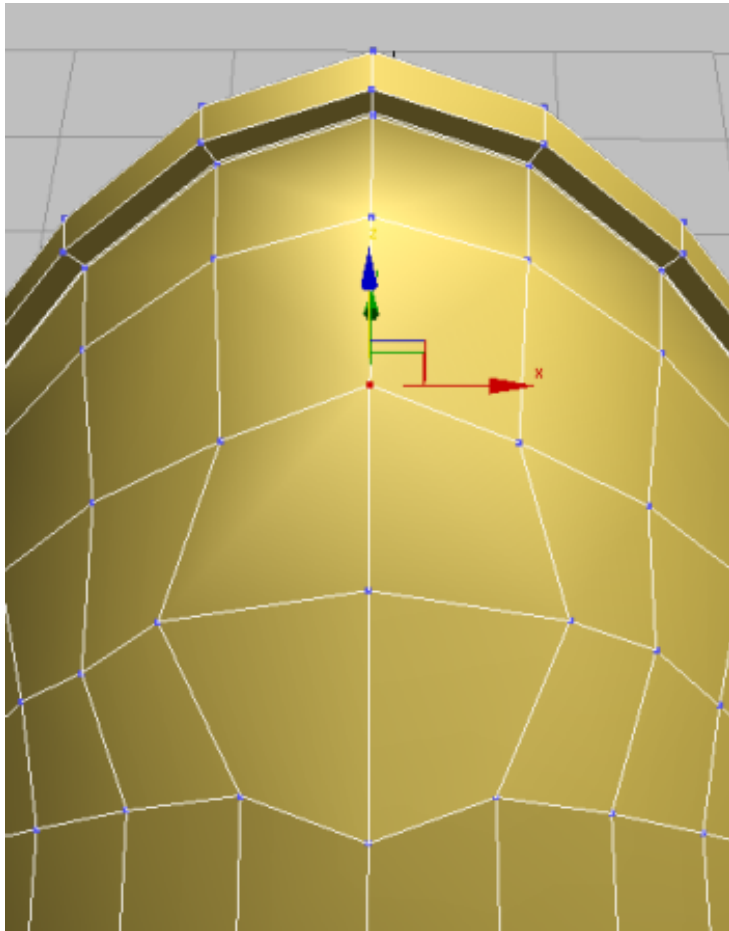

- 7 Select the vertex at the center of the circular group of polygons and on the Ribbon > Polygon Modeling panel, Ctrl+click the Polygon Selection tool.
This automatically selects all the polygons that share the vertex.
Next, you will create the socket from which you will extrude the Viking horn.
- 8 On the Polygons panel, Shift+click Inset.

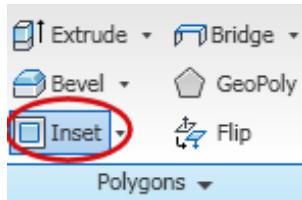

(When you Shift+click one of these tools, 3ds Max displays the settings dialog for that tool.)

- 9 On the Inset Polygons dialog, drag the Inset Amount spinner to a value of approximately **0.25**, then click OK.

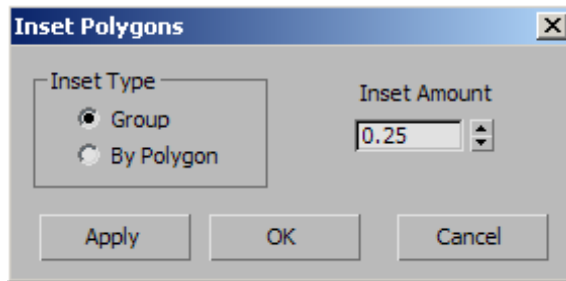

This creates an inset edge for the selected polygons.

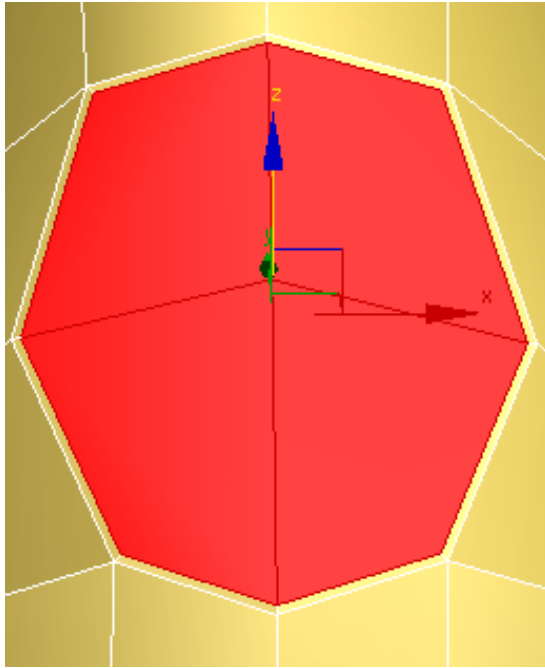

- 10** On the Polygons panel, Shift+click Extrude and in the Extrude Polygons dialog > Extrusion Type group, choose Group.
- 11** Set Extrusion Height to approximately **3.0** and click OK.
- 12** On the Polygons panel, Shift+click Bevel and on the Bevel Polygons dialog set height to **0.25** and Outline amount to **-0.5**, then click OK.

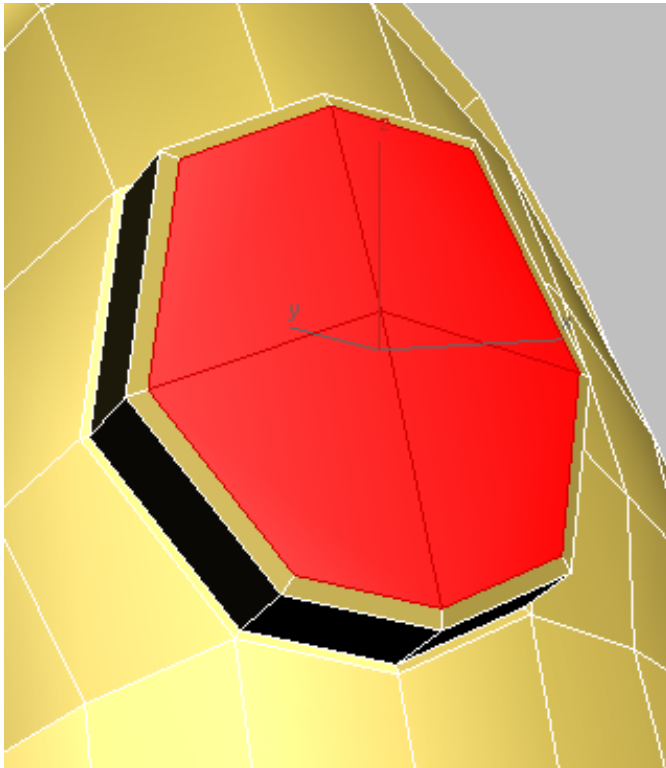

Helmet horn socket after first extrusion

- 13 On the Polygons panel, Shift+click Inset, and on the Inset Polygons dialog, set Inset Amount to **0.35**.
- 14 On the Polygons panel, click Bevel.

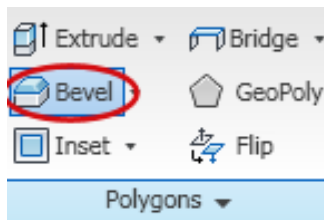

- 15 Drag the selected polygons slightly toward the inside of the helmet, then release the mouse and drag slightly down to bevel the extrusion slightly in toward its center. Click once to end the operation.

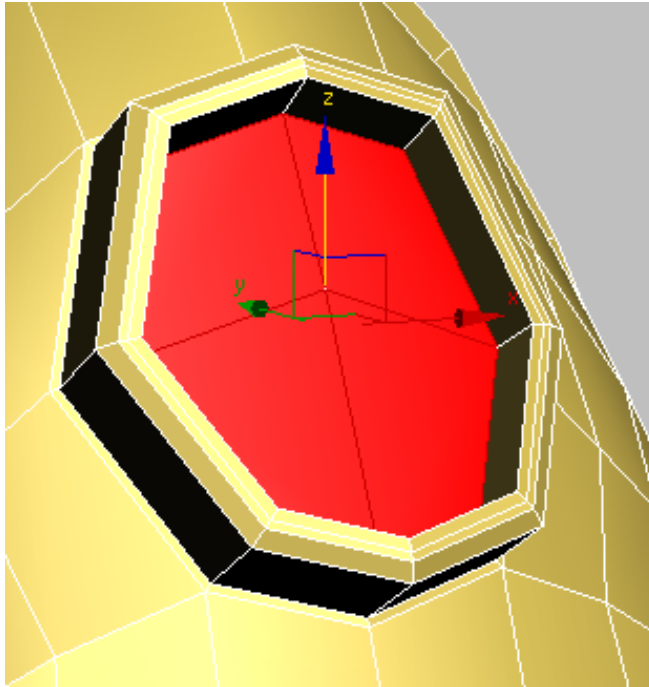

Horn socket after inset

- 16 Click Extrude again and drag away from the helmet until the polygons extend slightly beyond the socket. Click to end the extrude operation.

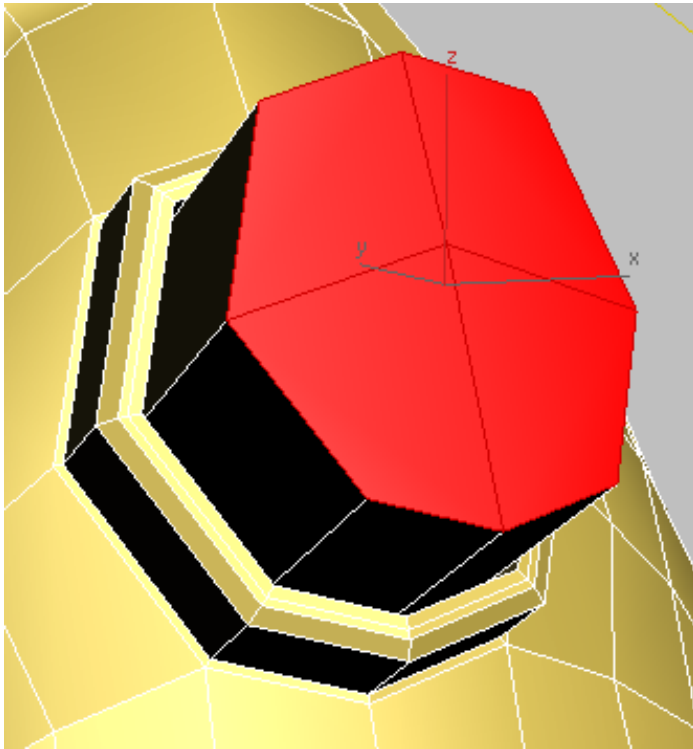

Helmet horn ready for spline-based extrusion

At this point, you could continue to create the horn by using the Move, Rotate and Scale tools, coupled with the Extrude, Bevel, and Inset polygon commands to extend the extrusion. Instead, you will guide the extrusion by means of a path.

Use a spline to extrude and shape a horn:

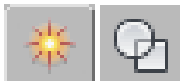

- 1 On the Create panel, click Shapes and on the Object Type rollout, click Line.
- 2 On the Creation Method rollout, choose Smooth for both Initial Type and Drag Type.

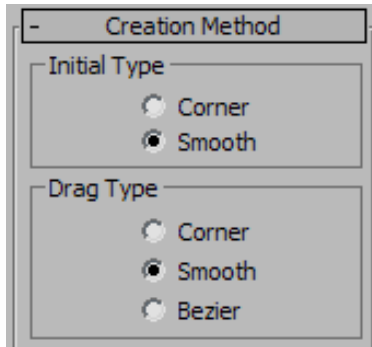

- 3 Press Alt+W to view all four viewports, and in the Top view draw a line extending from the horn socket. Click, drag, and click again, until you have created a line of four or five vertices. Right-click to end Line creation.

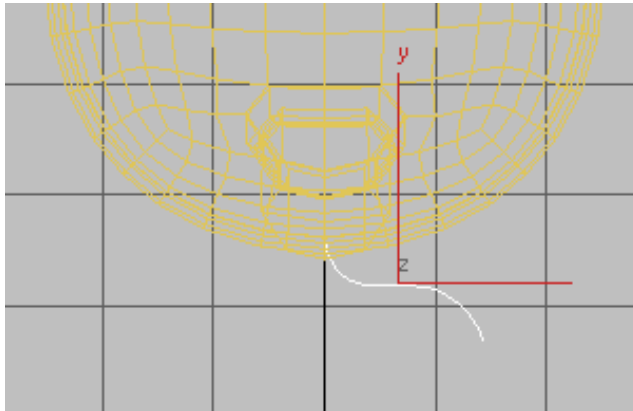

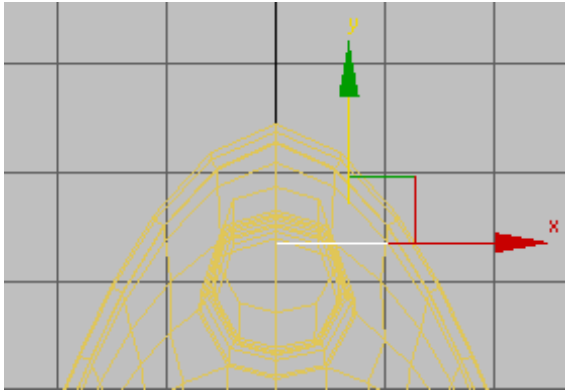

- 4 Zoom into the Front view and translate the line along its Y axis until it is centered in the horn socket. Move it along the X axis too, if you need to.



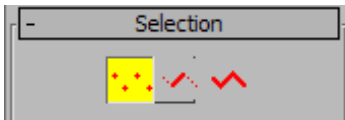

- 5  Go to the Modify panel > Selection rollout, and turn on Vertex selection mode.



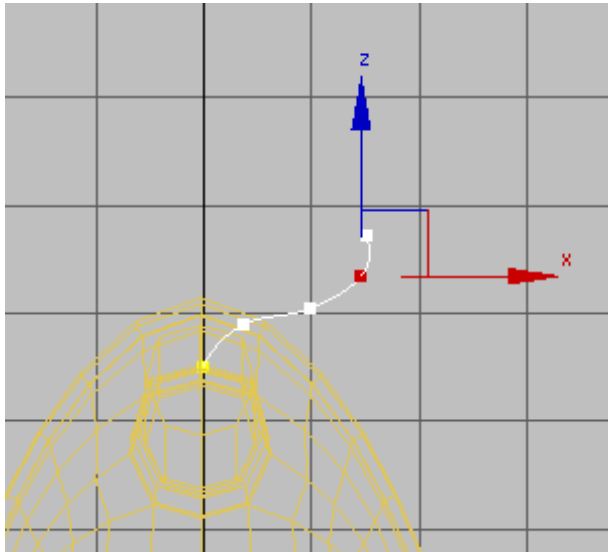

- 6   Maximize the Perspective view and move the line's vertices until they form the shape of the horn you want to create.



7  Double-check and refine your Line edits in the other viewports.

8  Click the Vertex button once more to turn it off.

9  Select the helmet, then on the Ribbon > Polygon Modeling panel, click the Previous Modifier button.

10   Activate Polygon selection mode, then click Show End result to turn it on.

11 On the Polygons panel drop-down panel, Shift+click Extrude On Spline.

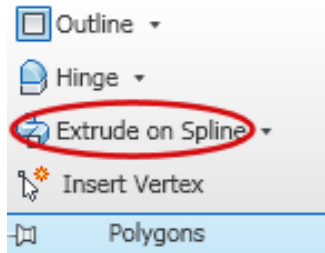

- 12 On the Extrude Polygons Along Spline dialog, click Pick Spline, and in the viewport, click the spline you drew earlier.

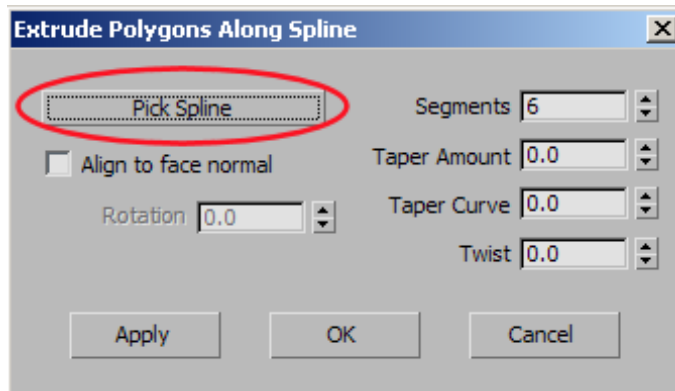

- 13 On the Extrude Polygons Along Spline dialog, turn on Align To Face Normal.
This lets you better duplicate the twist for the mirrored horn.
- 14 Adjust the Taper Amount, Twist, and Rotation values so the extruded faces look like a pair of horns.

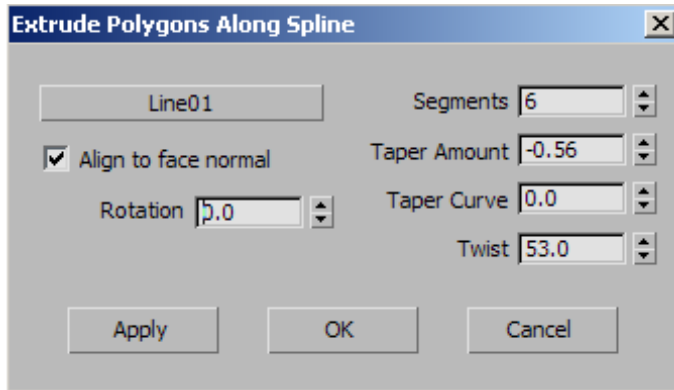

The values will differ, depending on the shape of the spline you drew. For the example shown in the illustrations, the values were Taper Amount = -0.56, Twist = 53.0, Rotation = 0.0.

- 15 Click Apply to view your edits to this point. Continue to use the dialog controls to shape your horns, then click OK when you are done.

By extruding the horns along a path, you saved yourself a great deal of back-and-forth between the transform tools.



- 16 On the Ribbon > Polygon Modeling panel, click the Polygon selection button again to turn it off.



- 17 On the Edit panel, make sure Use NURMS is off (this mode needs to be off before you transform the helmet into an editable poly).

- 18 Right-click the helmet in the viewport, choose Transform > Convert To > Convert To Editable Poly, then press F4 to turn off edged faces.

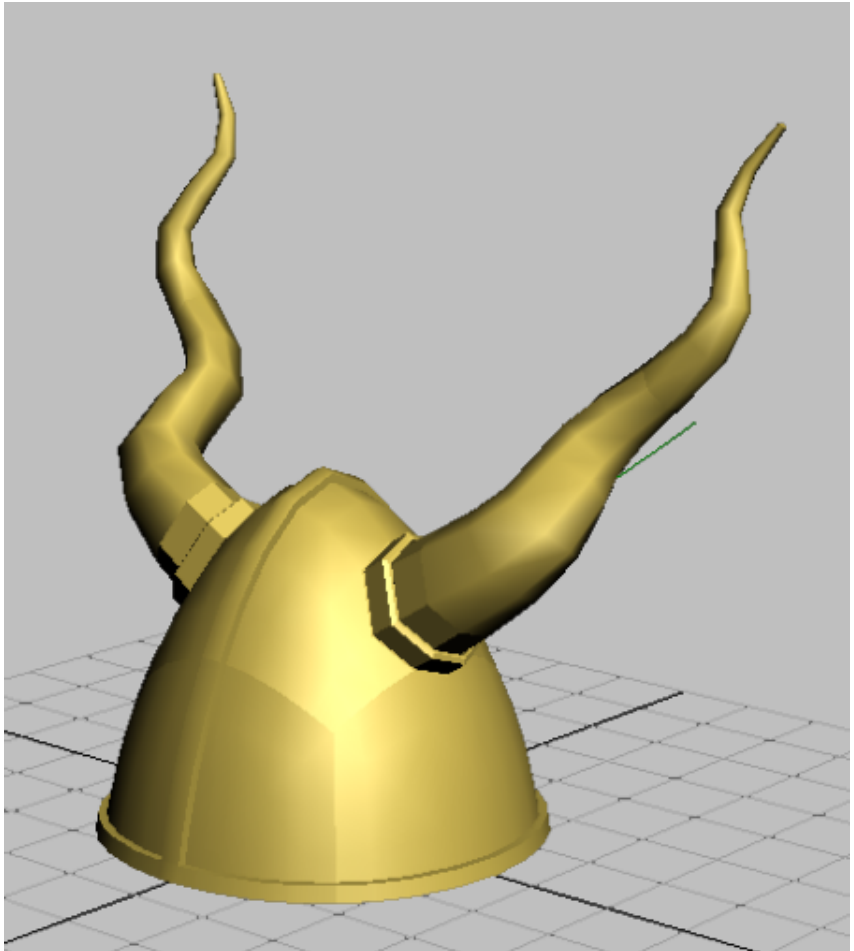

The Symmetry modifier is removed and all the mirrored polygons are integrated into the model.

- 19 Press F4 again to turn edged faces back on.
- 20 Save your scene as **my_helmet_04**.

Using Freeform Tools to Add Spikes to the Helmet

In this lesson, you will use a variety of freeform tools to create a ridge of irregular spikes for the Viking helmet.

Create irregular spikes using the Freeform tools:

- 1 Continue working from the previous lesson, or open *helmet_04.max*.



- 2 In the viewport, select the helmet object, make sure the Modify panel is active, and on the Ribbon > Polygon Modeling panel, activate Edge selection mode.

You will use this tool to remove the loop in the middle of the helmet seam.



- 3 On the Modify Selection panel, click Loop Mode to turn it on, then click an edge in the middle of the helmet seam, as shown in the next illustration.

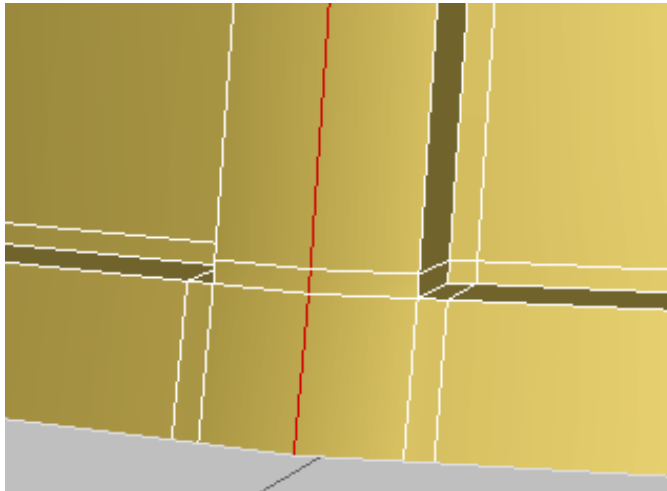

- 4 On the Edges panel, click Remove, then activate Vertex selection mode.

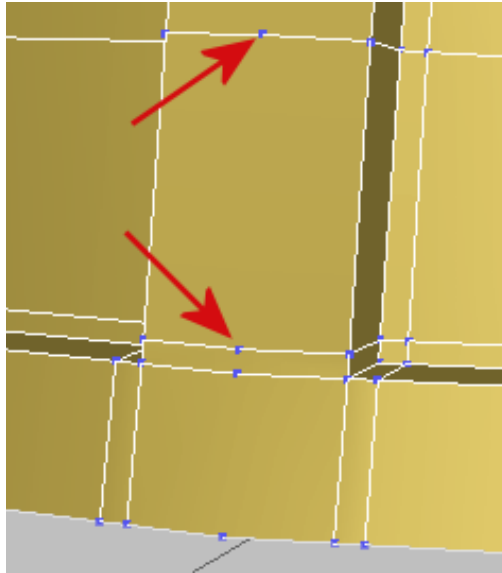
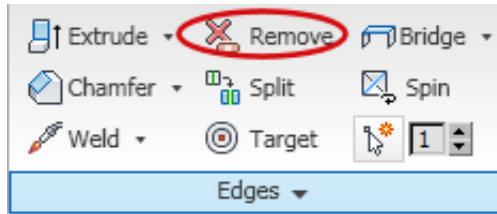

Unwanted vertices left over from edge removal

Notice that while the loop edges have been deleted, their vertices remain. You want to remove the vertices as well.



5 Undo the Remove operation so that the loop redisplay.

6 Activate Edge selection mode again and on the Edges panel, Ctrl+click Remove.

All the vertices are removed as well.



7 Select two vertical edges on the helmet seam, as shown in the next illustration.

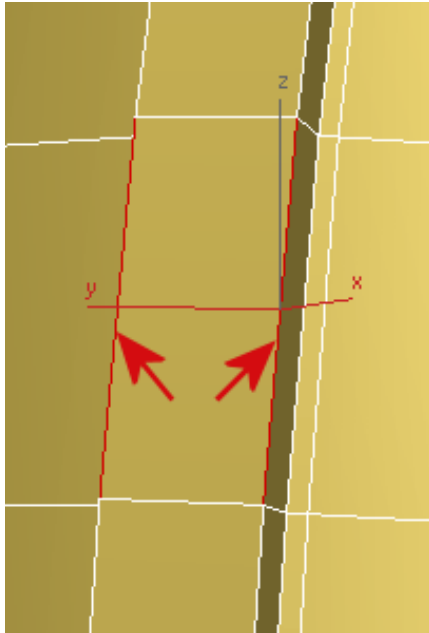

- 8** On the Loops panel, Shift+click Connect.
- 9** On the Connect Edges dialog, make sure Segments is set to **1** and Pinch and Slide are set to **0**, then click OK.
This ensures you are connecting the edges just once, with no offset.
- 10** Click the next pair of edges above and click Connect to add another edge to the seam.
- 11** Repeat the previous step for each set of edges in the seam. Stop when you connect an equal number of polygons on the opposite side of the helmet.

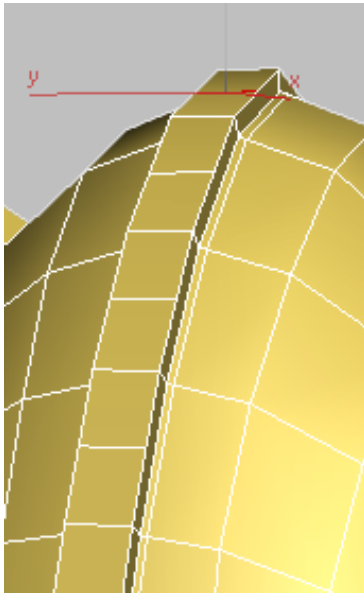

12 On the Ribbon > Polygon Modeling panel, activate Polygon selection mode.

13 Select the polygon at the base of the seam.

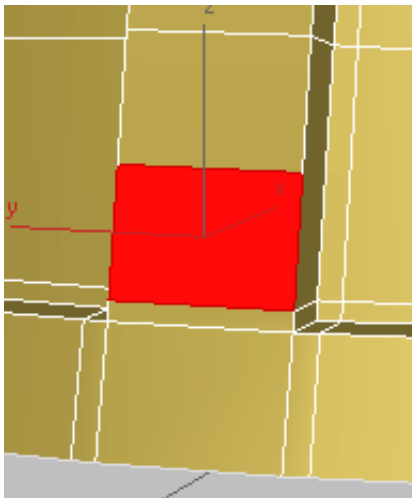

- Adjust the Perspective view to make sure you are looking at the helmet from an oblique angle.

NOTE If you start extruding the polygon while looking at the model head on, the extrusion will take on a 2D appearance.

- On the Ribbon, click the Freeform tab, and on the PolyDraw panel, click Branches.

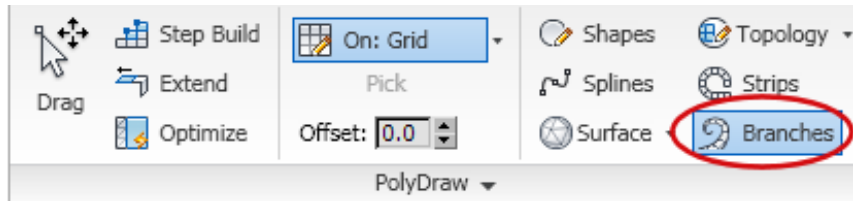

- Shift+drag the selected polygon outward, away from the helmet, then release the mouse.

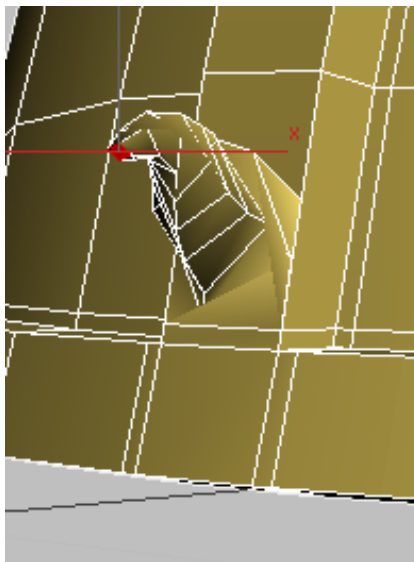



Helmet after first Branch extrusion

- Ctrl+click to select the next polygon (two above the current one), and then Shift+drag to perform the extrusion.

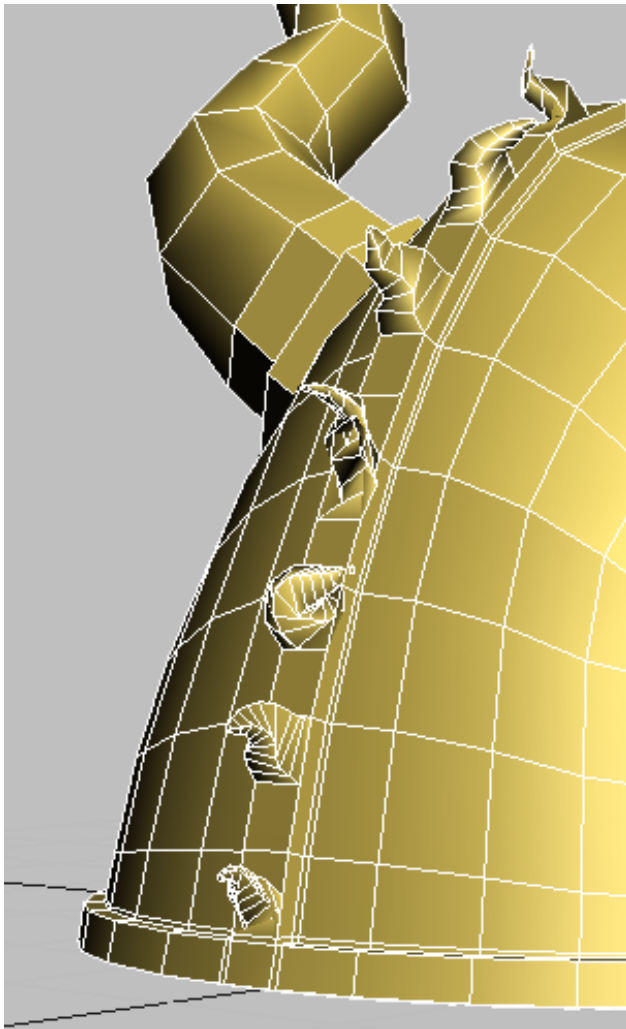
- 18** Continue extruding every second polygon until the entire ridge is complete.



As you progress along the helmet, make sure you maintain an oblique view of the polygons. If you don't like the shape of an extrusion, or extrude the wrong polygon, press Ctrl+Z to undo the operation.

- 19  On the Ribbon > Polygon Modeling panel, click the Polygon selection button to turn it off, then press F4 to turn off edged faces.
- 20  On the Edit panel, click Use NURMS to turn it on.

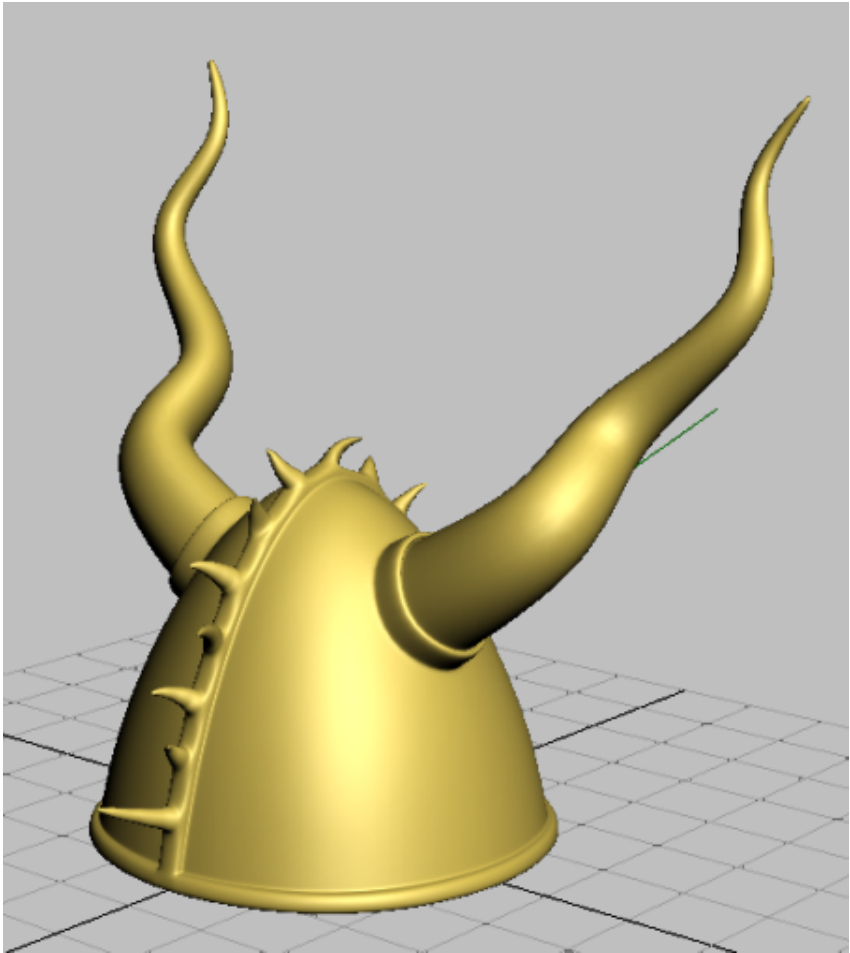

The helmet geometry is smoothed out and ready to accept materials.

Summary

Throughout this tutorial, you used a number of modeling tools on the Graphite Modeling Tools Ribbon to create a Viking helmet. While these tools are also available from the Command panel, the Ribbon gives you faster access, in context, as you need them.

This tutorial only scratched the surface of the many ways in which you can use the Ribbon for editing mesh and polymesh objects. For a full description of the Ribbon tools, consult the 3ds Max help.